



Surgicals Instruments

*Bones Carving Tools*

**ORTHOPAEDIC  
— INSTRUMENTS —**

*Our Experience is Your Trust*

DOOR No. 17/240, MELOOR P O, CHALAKUDY, THRISSUR, KERALA - 680 311

Email: [info@globaltecsurgicals.com](mailto:info@globaltecsurgicals.com), [sales@globaltecsurgicals.com](mailto:sales@globaltecsurgicals.com), [customer care@globaltecsurgicals.com](mailto:customer care@globaltecsurgicals.com),

Website: [www.globaltecsurgicals.com](http://www.globaltecsurgicals.com). Phone: +91 0480 2733660 Mob: +91 9349855004

## Introduction

GlobalTec Surgical is a highly experienced manufacturer of surgical instruments. With our wide range of products, we provide instruments for surgeries from head to toe.

We present our catalogue detailing our range of instruments specialising in orthopaedic surgery.

Our specialist instruments are manufactured to the highest possible standards using the most modern processes and technology. Based in Thrissur, the cultural capital of Kerala - "God's Own Country" - we leverage technological advancements to deliver world-class surgical solutions.



*The*  
EXCELLENCE  
*Along* EXPERIENCE



+91 7994555004  
Office +91 04802733660  
sales@globaltecsurgical.com

DOOR No. 17/240, MELOOR P O, CHALAKUDY, THRISSUR, KERALA - 680 311

Email: info@globaltecsurgical.com, sales@globaltecsurgical.com, customercare@globaltecsurgical.com,

Website: www.globaltecsurgical.com. Phone: +91 0480 2733660 Mob: +91 7994555004

**ORTHOPAEDIC INSTRUMENTS**
**INDEX**

Page No.

Elevators	4-9
Bone Hook	10
Bone Spreaders	11
Bone Cutters	12
Bone Niblers	13
Bone Holding Forceps	16
Pelvic Reduction	18
Retractors	20
Mallets	26
Osteotomes & Gouges	28
Bone Curettes .	32
Revision Instruments	33
Hip Joint Instruments	
Pliers & Wire Cutters	40
Locking Pliers	43
Pin Introducers	44
MISC	45
Bone Mill - Wire Passers	
Screw Drivers	46
Dissectors	48
Measuring Instruments	49
Shoulder Surgery Instruments	50

## ELEVATORS

### Adson Periosteal Elevator

- 16cm/6¼" Length
- Curved Blunt

	Width
ORGT 3052-16	2 mm
ORGT 3055-16	5 mm
ORGT 3057-16	7 mm
ORGT 3054-16	4 mm



### Pennybacker Periosteal Elevator

- 16cm/6½" Length
- Curved Sharp

	Width
ORGT 3054-16	4 mm
ORGT 3066-16	6 mm
ORGT 3068-16	8 mm



### Bone Raspatory with Tufnol Handle

- 19cm/7½" Length

Straight	Width
ORGT 7016-19	6mm
Conical Straight ORGT 7015-14	

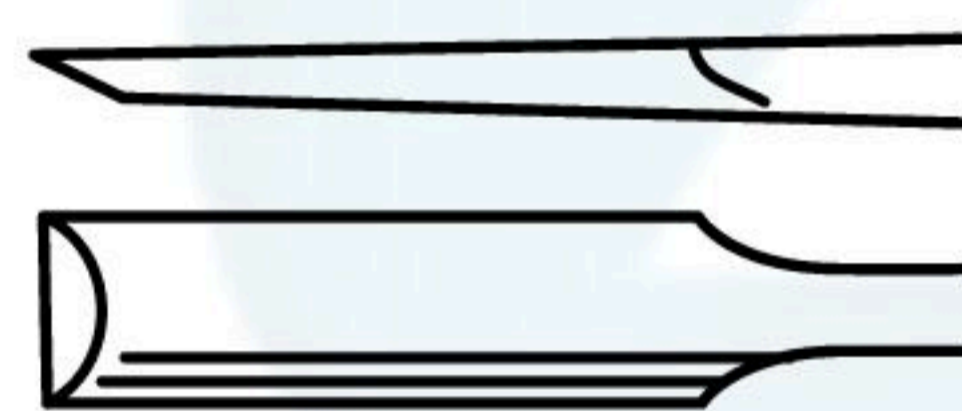

Curved	Width
ORGT7023-19	3mm
ORGT7026-09	6mm
Conical Straight ORGT 7015-14	

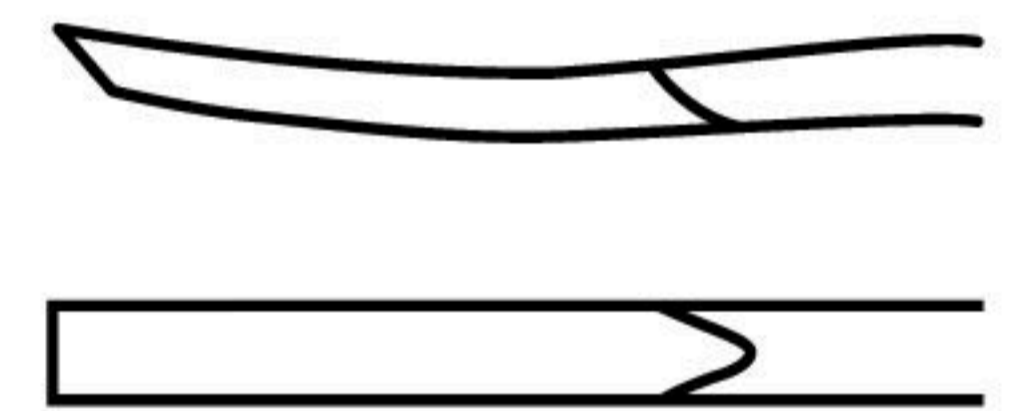

### Farabeuf Rugine Elevator

- 15cm/6" Length

Straight	Width
ORGT 3001-15	12mm
ORGT 3001-05	5mm
Curved*	
ORGT 3002-15	12mm
ORGT 3002-05	5mm



\*Illustrated

### Farabeuf Rugine Elevator with Hollow Handle

- 16cm/6¼" Length

Straight	Width
ORGT 3011-16	12mm
Curved*	
ORGT 3012-16	12mm



\*Illustrated

## ELEVATORS

### Key Elevator

- 18cm/7" Length

ORGT 874	6 mm
ORGT 875	12 mm
ORGT 876	19 mm
ORGT 877	25 mm



### Trethowan Bone Elevator

- 22.5cm/8½" Length

ORGT 3030-22



### Lanes Bone Elevator

- 26cm/10" Length

ORGT 3031-26



### Fagge Bone Elevator

- 27.5cm/10¾" Length

ORGT 3032-27

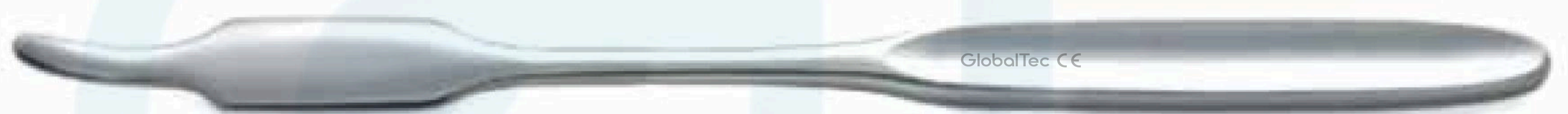

### Bristow Periosteal Elevator

- 23cm/9" Length
- Curved sharp
- 10mm width

ORGT 3003-10

- 15mm width

ORGT 3003-15



### Femoral Dislocation Lever

- 31cm/12½" Length
- 26mm width

ORGT 3026-31



### Muller Femoral Retractor

- 35cm/13½" Length
- 28mm width

ORGT 3028-35



For retraction of the femoral neck.

## MINI ELEVATORS

### Mini Bone Lever

- 14cm/5½"
- 2.8mm width

ORGT 5830-14



### Hohmann Style Mini-Bone Lever

- 16cm/6½"
- 6mm width

ORGT 5831-16

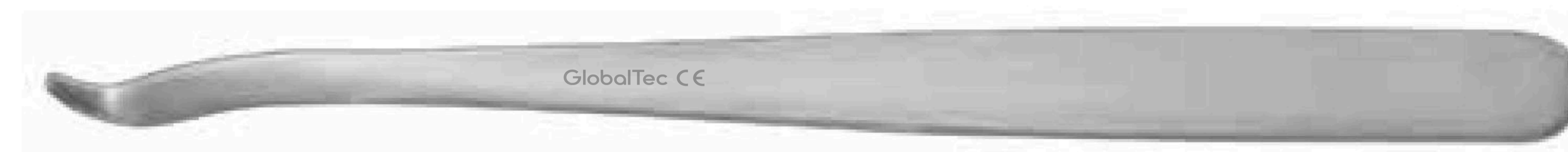

### Phalangeal Lever

- 15cm/6"
- 5mm width

ORGT 5832-16



### Buck-Gramcko Lever

- 15cm/6"
- 7.5mm width

ORGT 5833-15



### Mini-Cobra Bone Lever

- 16cm/6¼"
- 15mm width

ORGT 5834-16



### McGlamry Metatarsal Elevator

- 17cm/6½"
- Sharp

Width

ORGT 5835-10

9mm

ORGT 5835-12

11mm

ORGT 5835-14

13mm

ORGT 5835-16

15mm

ORGT 5835-19

19mm



## ELEVATORS

### Hohmann Bone Elevator

- 22cm/8½" Length

Width

ORGT 3009-08  
ORGT 3009-10  
ORGT 3009-15

8mm  
10mm  
15mm



### Hohmann Style Mini-Bone Lever

- 24cm/9½" Length

Width

ORGT 3018-17  
ORGT 3018-22

17mm  
22mm

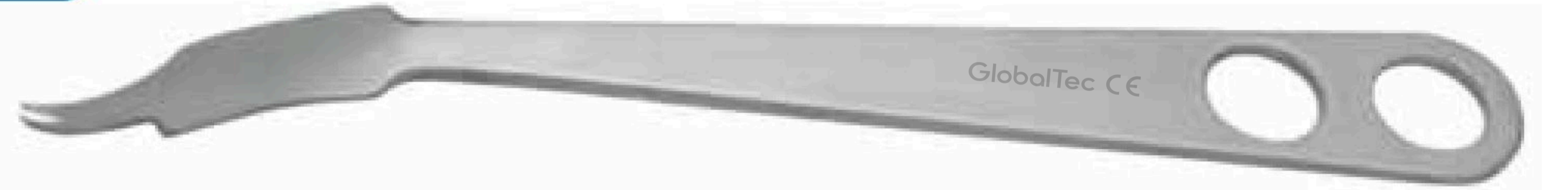

### Hohmann Bone Elevator

- 24cm/9½" Length

Width

ORGT 3043-33  
ORGT 3043-35  
ORGT 3043-44

33mm  
35mm  
44mm

- 28cm/11" Length

Width

ORGT 3033-33  
ORGT 3033-44

33mm  
44mm



### Hohmann Large Bone Elevator

- 24cm/9½" Length
- 70mm width

ORGT 3012-70



### Hohmann Bone Elevator Blunt

- 28cm/11" Length
- 35mm width

ORGT 3033-35



### Hohmann Bone Elevator

- 26cm/10" Length
- 24mm width

ORGT 3024-24



## ELEVATORS

### Long Curved Hohmann Inferior Hip Elevator

- 40cm/16" Length
- 22cm Width

ORGT 3022-40

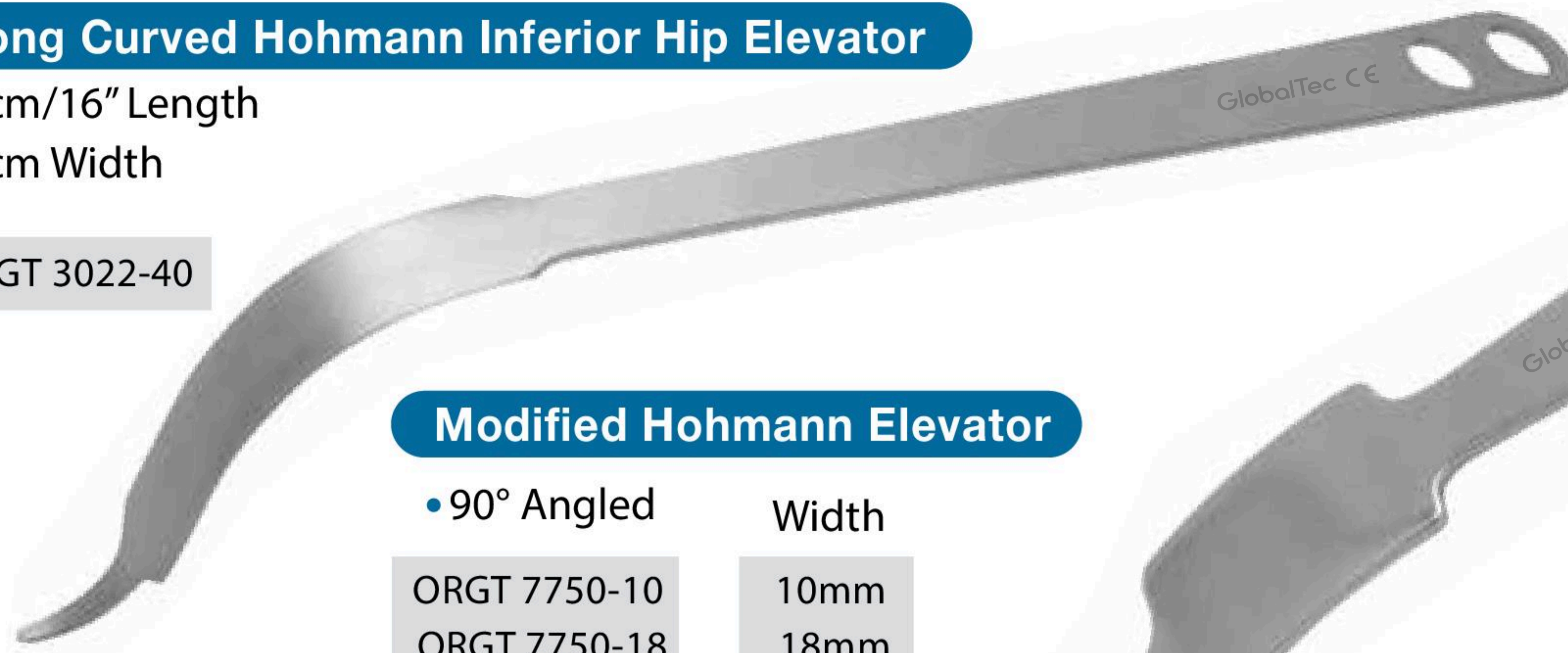

### Modified Hohmann Elevator

• 90° Angled	Width
ORGT 7750-10	10mm
ORGT 7750-18	18mm
ORGT 7750-25	25mm
ORGT 7750-43	43mm
ORGT 7750-70	70mm



### Modified Cobra Aufrang Elevator

- 33cm/13" Long Blade
- 30mm x 100 mm

ORGT 7742-10



### Shallow Bone Elevator

- 25cm/9¾" Length

ORGT 7755-25



### Concave Moor Elevator

- 33cm/13" Long Blade

ORGT 7742-20



### Bennet Elevator

- 25cm/10" Long Blade

ORGT 3080-40

## ELEVATORS

### Murphy Bone Skid Elevator

- 28cm/11" Length
- For dislocation of the femoral head
- Double ended

ORGT 0589-23



### Intero-Posterior Acetabular Capsule Retractor

- 35cm/14" Length

Right  
ORGT 7772-10



Left  
ORGT 7772-20

### PCL Retractor

- 25cm/10" Length
- To straddle the cruciate ligament
- 4mm wide prongs
- 21mm wide tips

ORGT 7761-10



### Wide Prong PCL Retractor

- 25cm/10" Length
- To straddle the cruciate ligament
- 5mm wide prongs
- 23mm wide tips

ORGT 7762-10



## BONE HOOKS

### Bone Hook Sharp

- 24.5cm/9¾" Length
- Sharp

ORGT 9050-24



### Blunt Hook

- 20cm/8" Length

ORGT 9051-20



### Wroblenski Dislocating Hook

- 25cm/10" Length
- For Hooking around the neck of the Femur

ORGT 9055-25



**BONE SPREADERS**

**Scaphoid Spreader- Fine Pattern**

- 14cm/5½" Length
- 1 x 2 Prongs

6mm

ORGT 5131-14

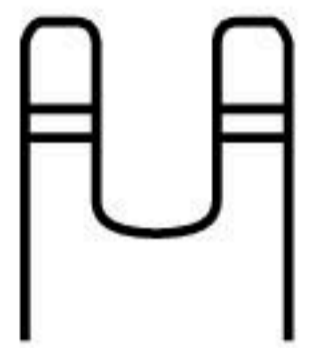

**Scaphoid Spreader-Standard Pattern**

- 14cm/5½" Length

6mm

ORGT 5134-14

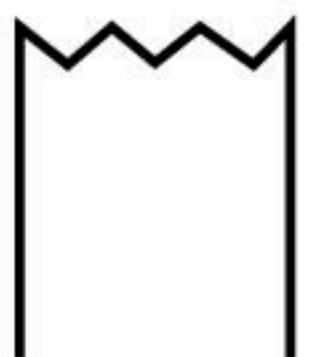

**Baby inge Bone Spreader**

- 18cm/7" Length

7mm  
Toothed

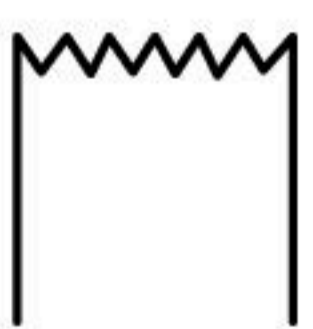

ORGT 5134-18

7mm  
Smooth

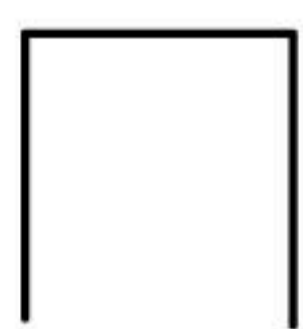

ORGT 5134-185

7mm  
Cross Serrated

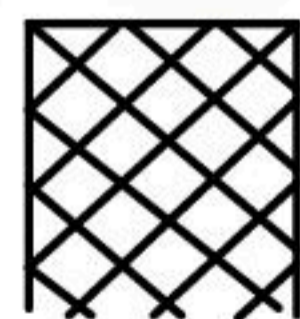

ORGT 5134-18X



**Femoral Tibial Spreader**

24cm/9½"

ORGT 2020-24

20cm/8"

ORGT 2020-20



## BONE CUTTERS

### Bohler Bone Cutters

- 15cm/6" Length
- Double Action

Straight  
ORGT 5160-50

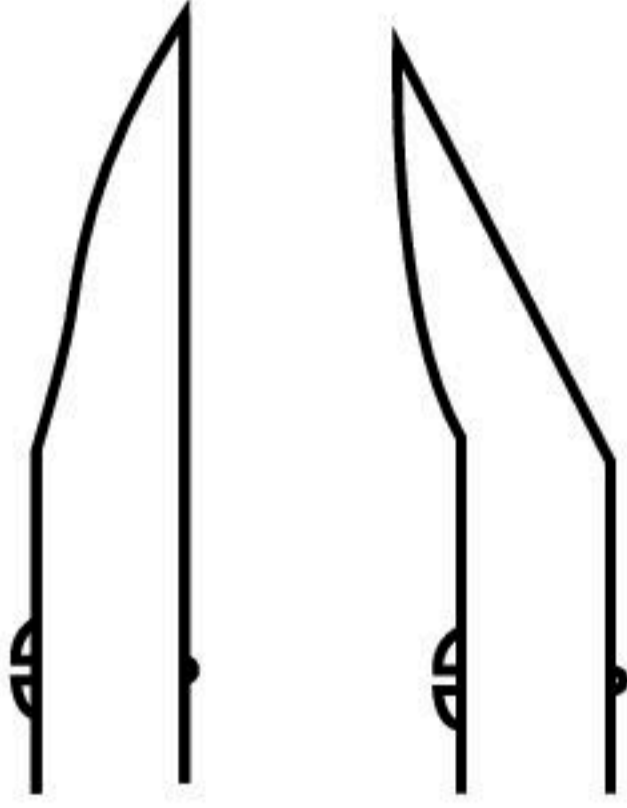

Angled  
ORGT 5161-50

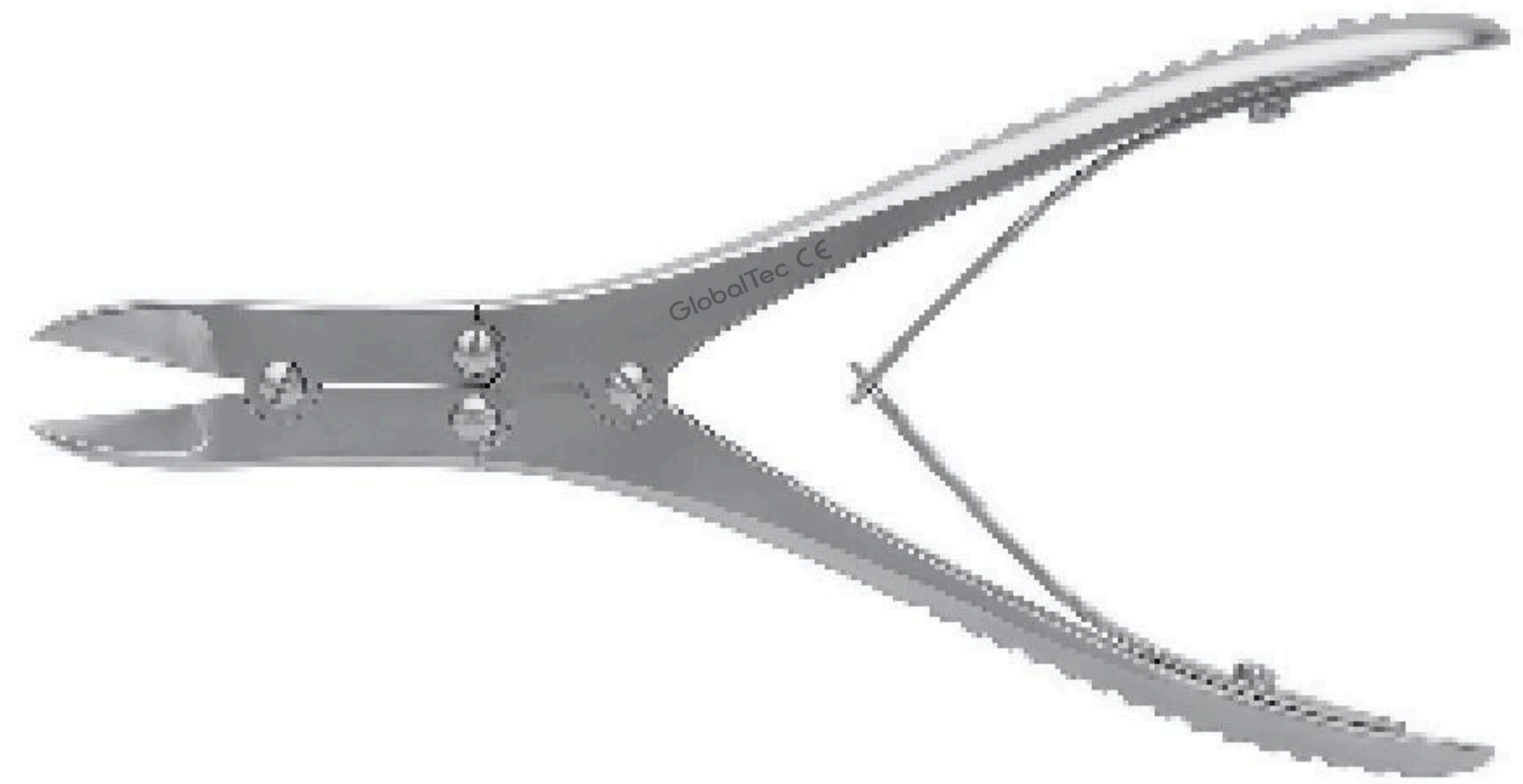

### Mcindoe Bone Cutters

- 18cm/7" Length
- Double Action
- Angled Jaws

ORGT 1028-18



### Ruskin-Liston Bone Cutters

- 19cm/7½" Length
- Double Action

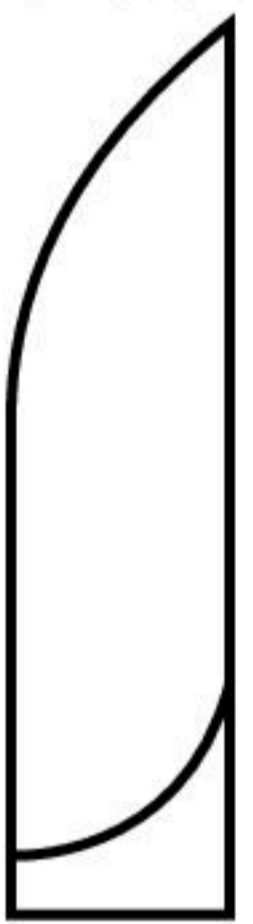

Straight  
ORGT 5170-19

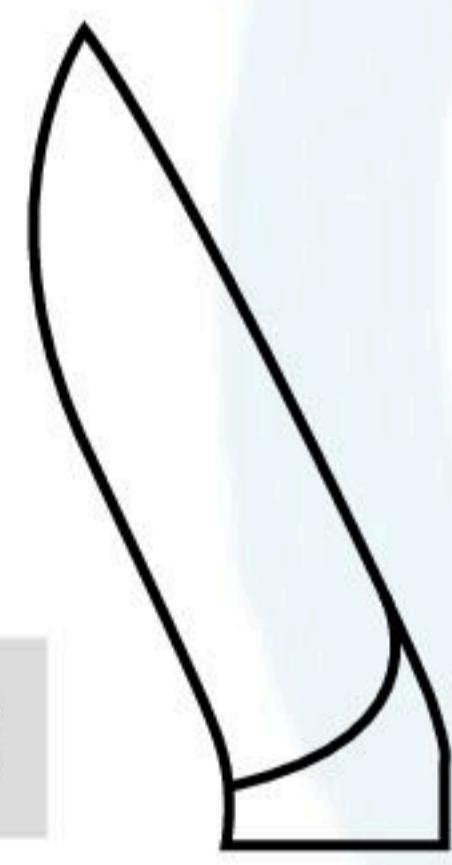

Angled  
ORGT 5171-19

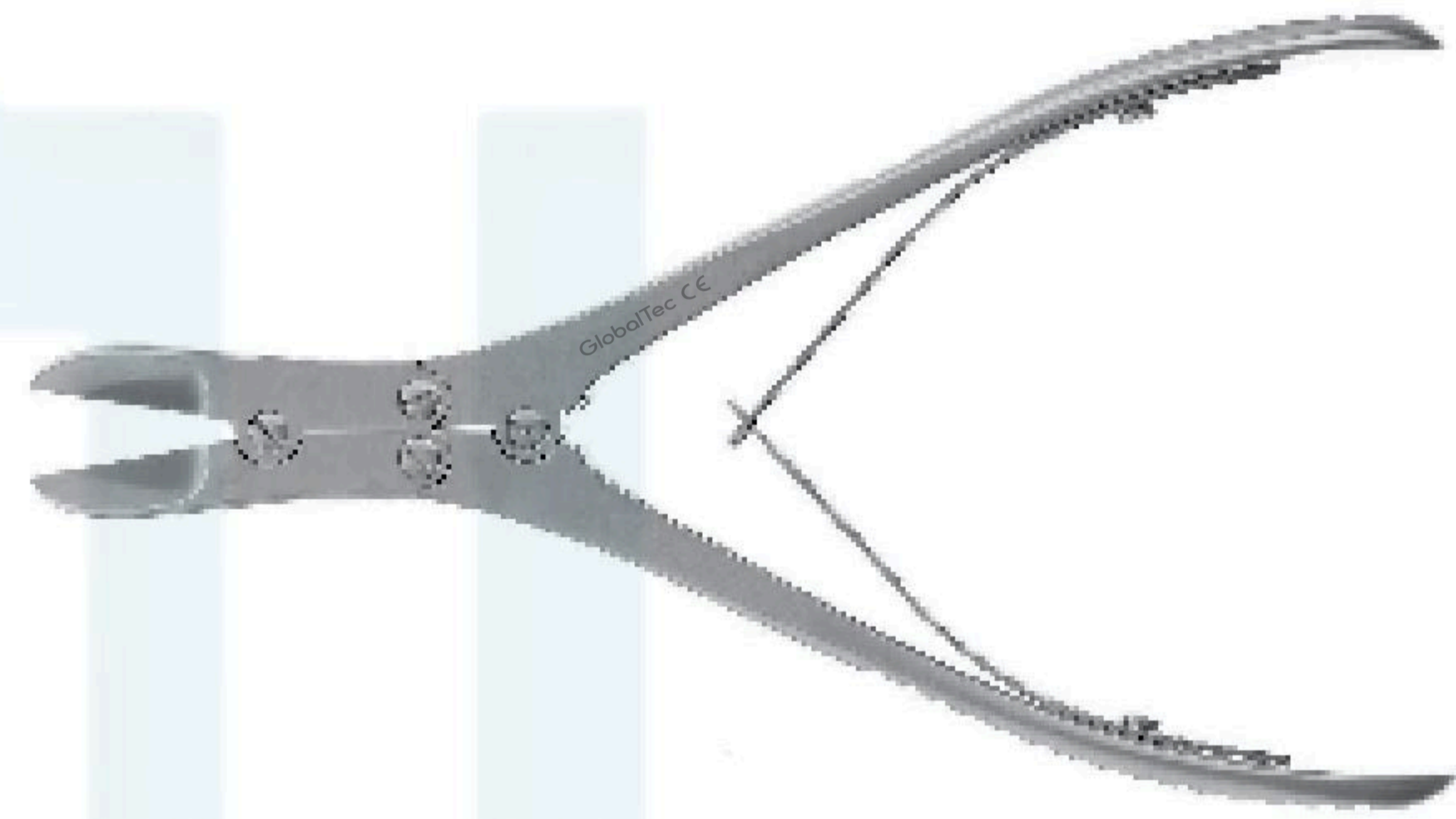

### Stille-Liston Bone Cutters

- 27cm/10¾" Length
- Double Action

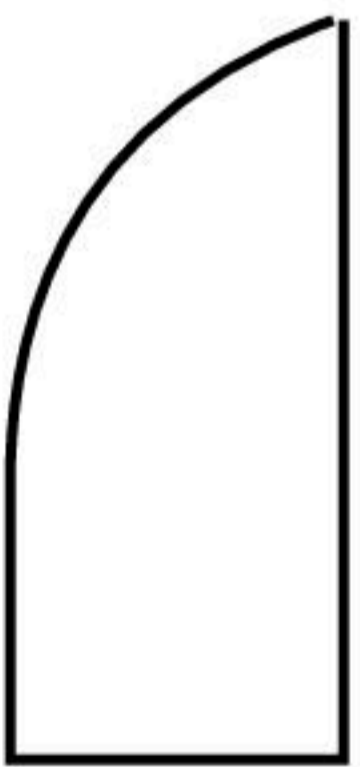

Straight  
ORGT 1024-27

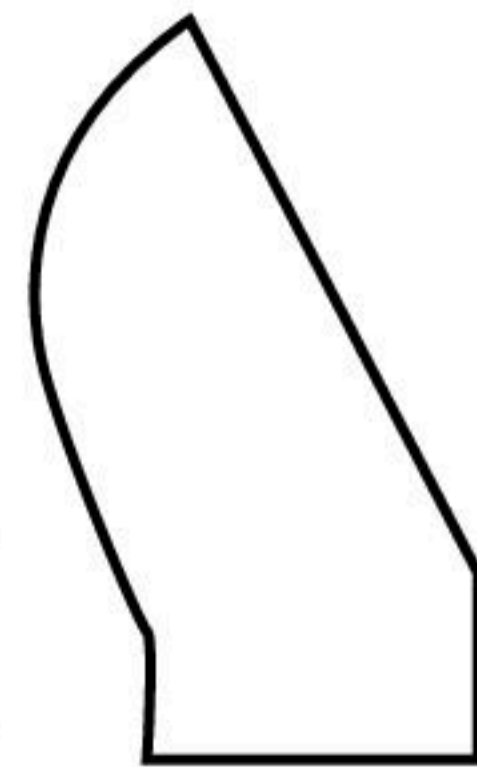

Angled  
ORGT 1025-27



### ListonKey-Horsley Bone Cutters

- 27cm/10¾" Length
- Double Action
- Angled

ORGT 1023-27

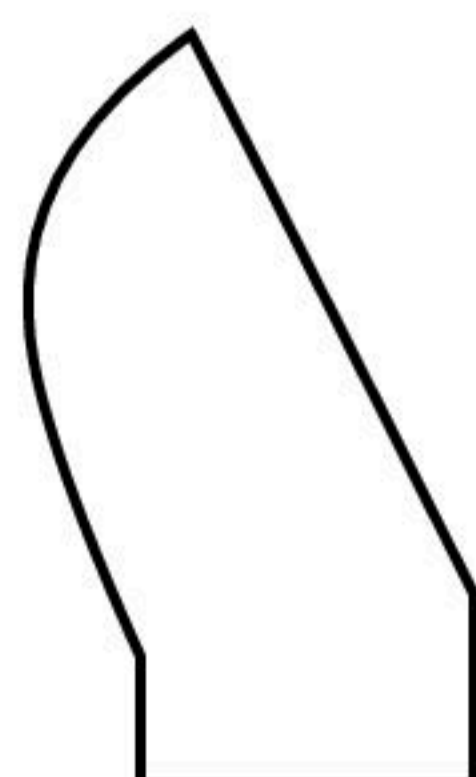

## BONE NIBBLERS

### Kleinert-Kutz Bone Nibbler

- 14cm/4½" Length
- Curved

8mm Bite

ORGT 5118-50



### Lempert Kutz Bone Nibbler

- 19cm/7½" Length
- Single Action

3mm Bite

ORGT 1001-19

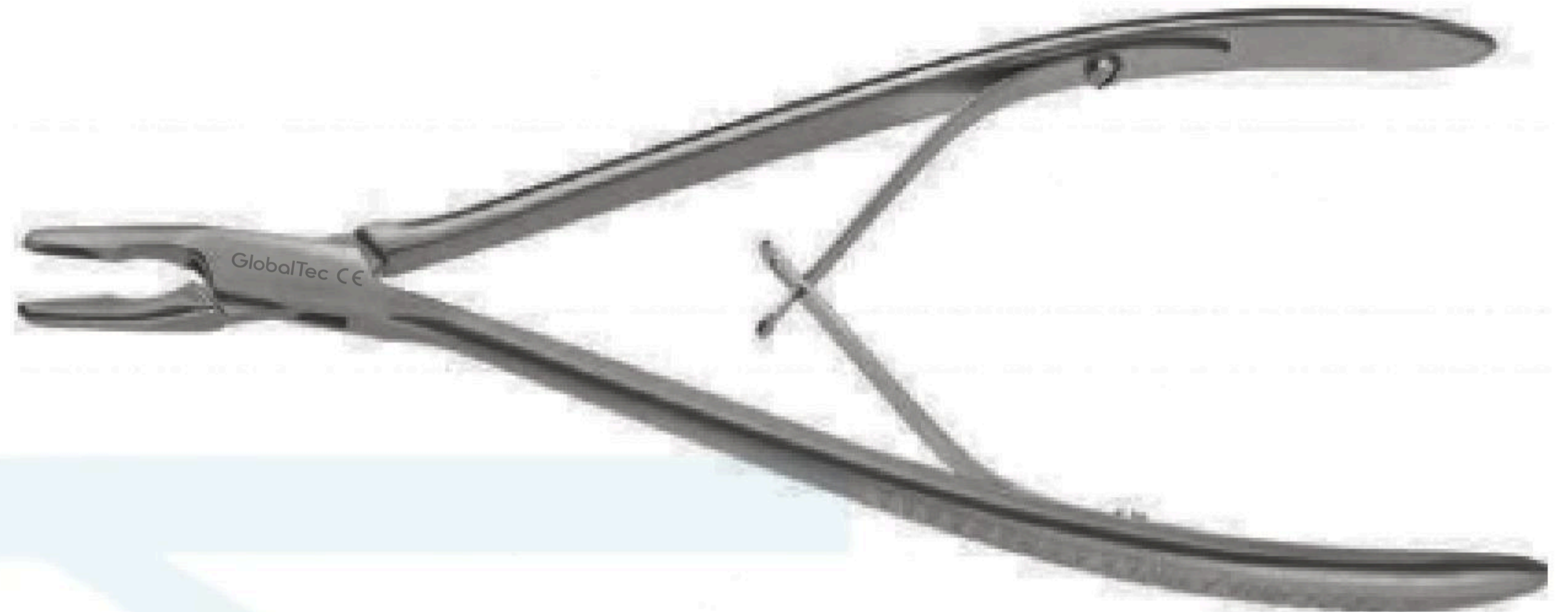

### Luer Bone Nibbler

- 18cm/7" Length
- Single Action

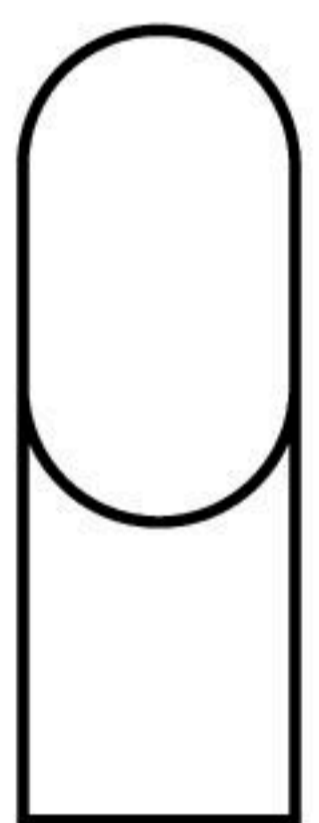

Straight  
8mm Bite

ORGT 1004-18

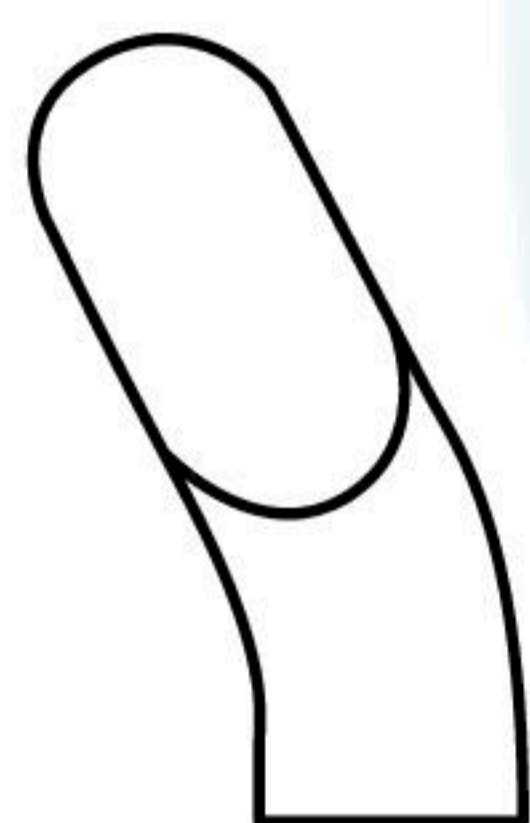

Curved  
8mm Bite

ORGT 1005-18

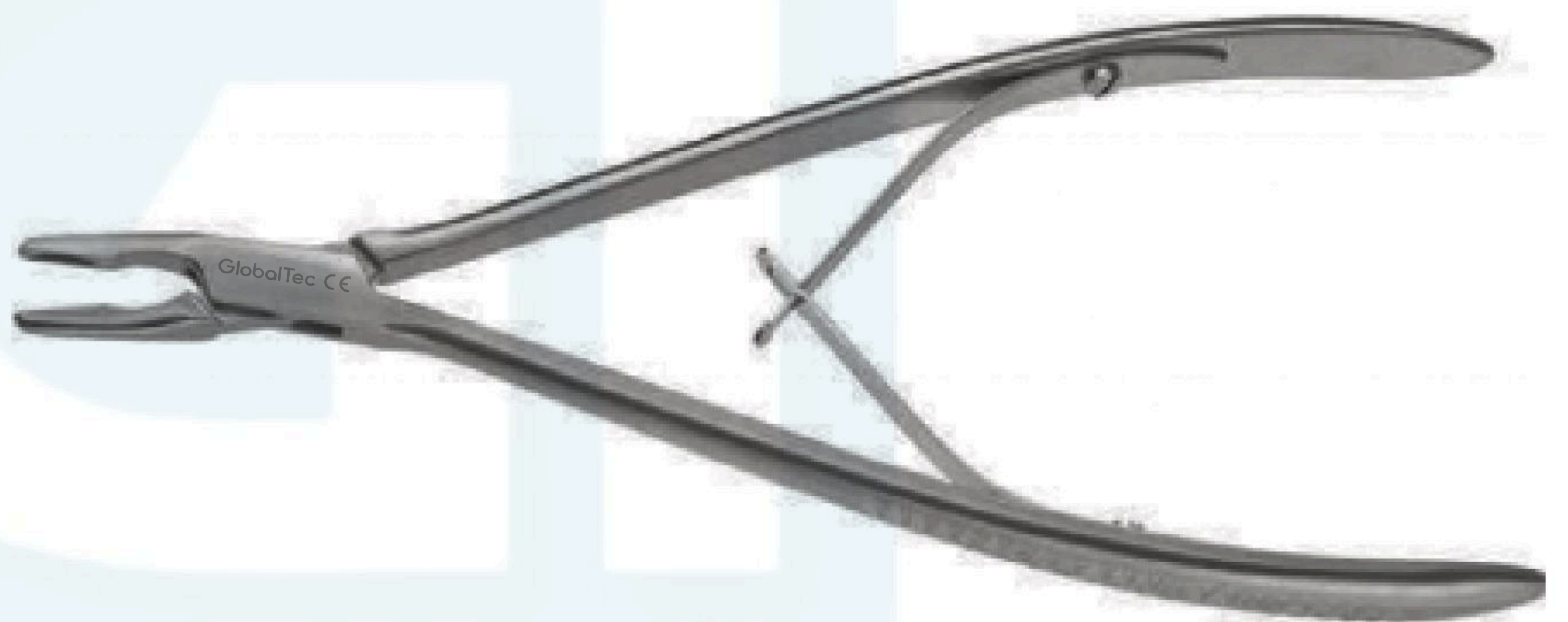

### Adsons Bone Nibbler

- 27cm/10½" Length
- Double Action

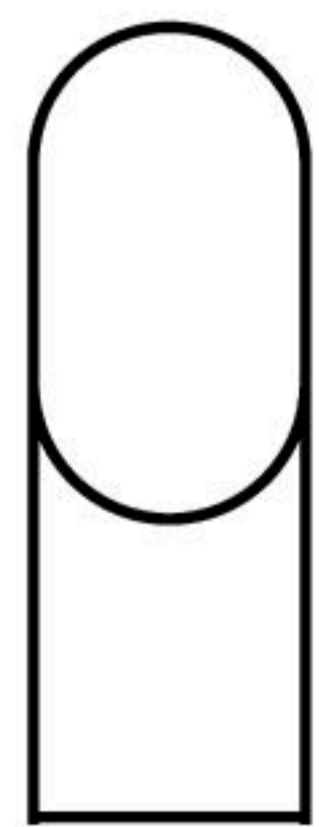

Straight  
7mm Bite

ORGT 1040-20

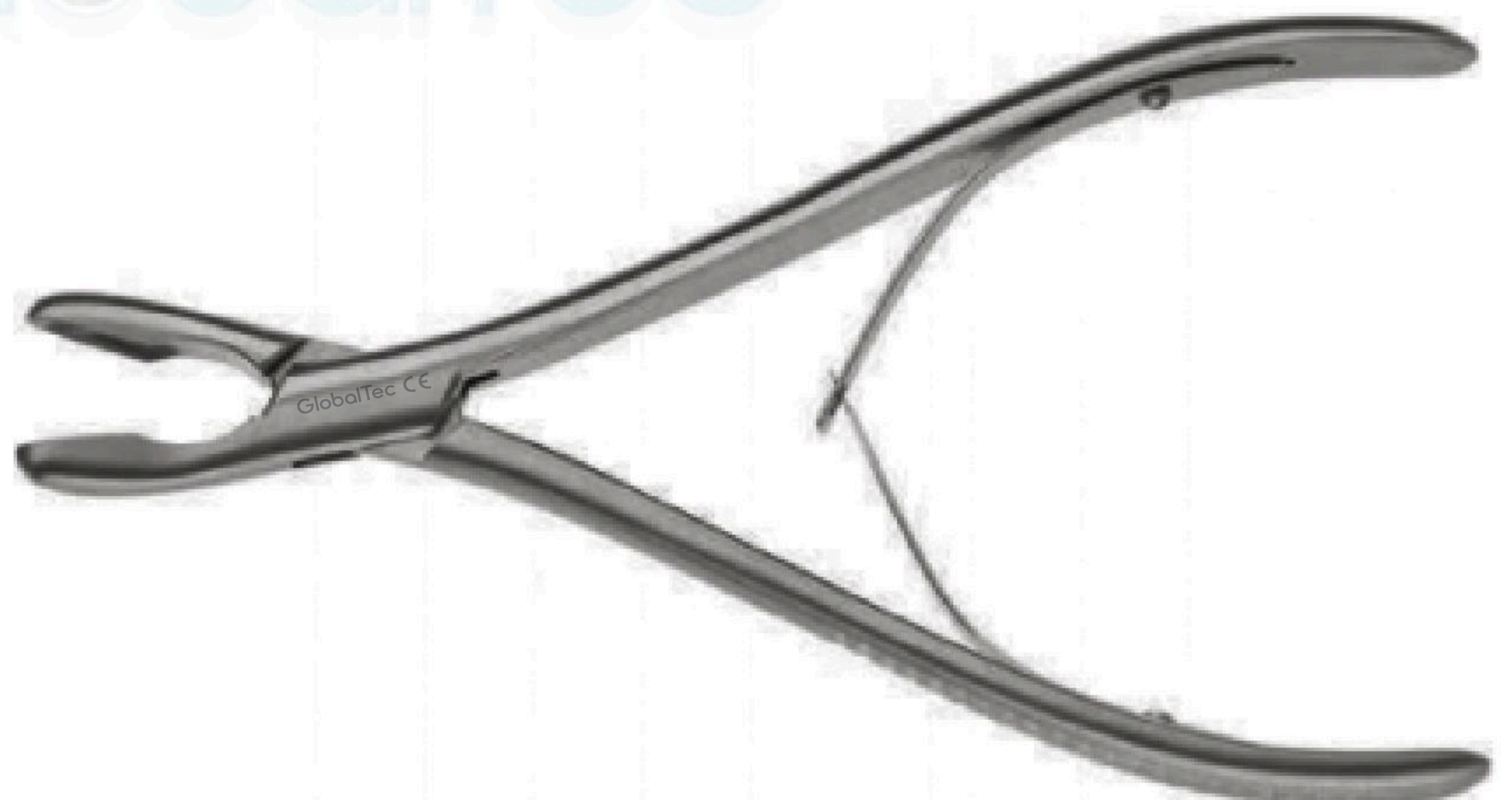

## BONE NIBBLERS

### Bohler Bone Nibbler

- Curved Double Action
- 15cm/6"

3mm Bite

ORGT 5120-50



### Marquardt Bone Nibbler

- 20cm/8" Length
- Curved Double Action

3mm Bite

ORGT 1002-20

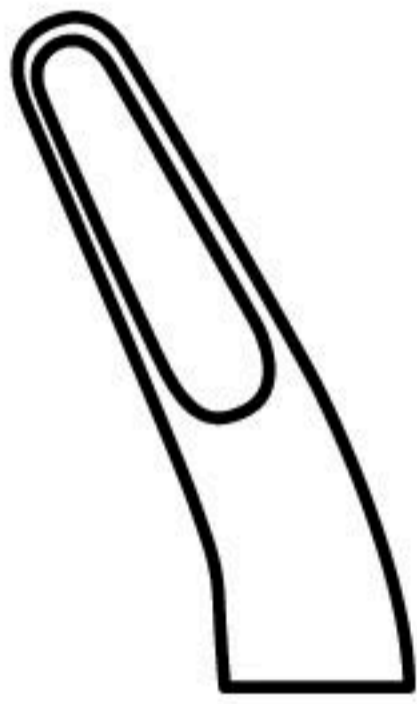

### Beyer Bone Nibbler

- Curved Double Action
- 18cm/7"

4mm Bite

ORGT 1002-18

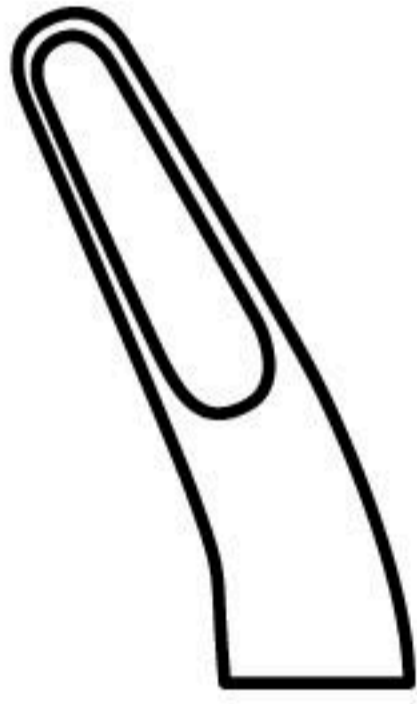

20cm/8" Curved

ORGT 1001-20

20cm/8" Straight

ORGT 1002-20



### Jansen Bone Nibbler

- Curved Double Action
- 18cm/7"

5mm Bite

ORGT 1003-18

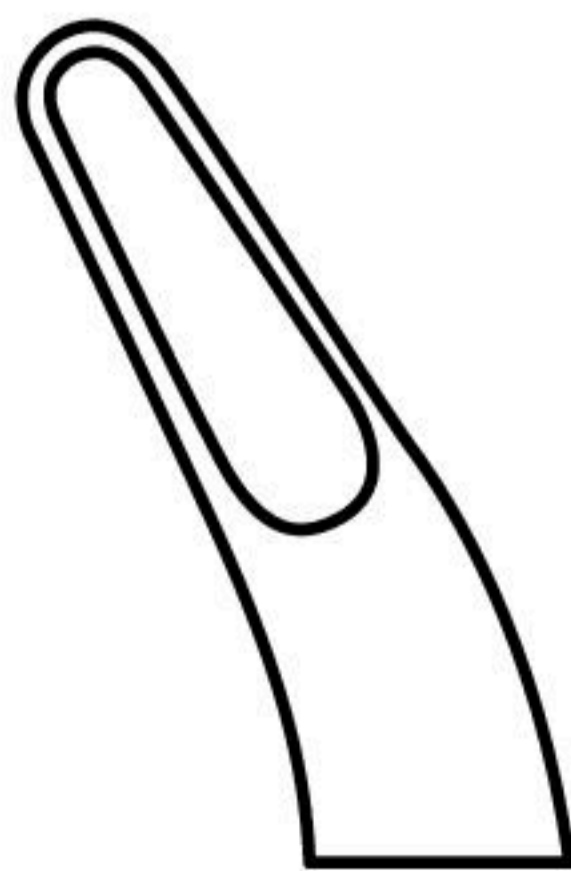

18cm/7" Straight

7mm Bite

ORGT 1103-18



## BONE NIBBLERS

### Smith-Peterson Bone Nibbler

- 24cm/9½" Length
- Double Double

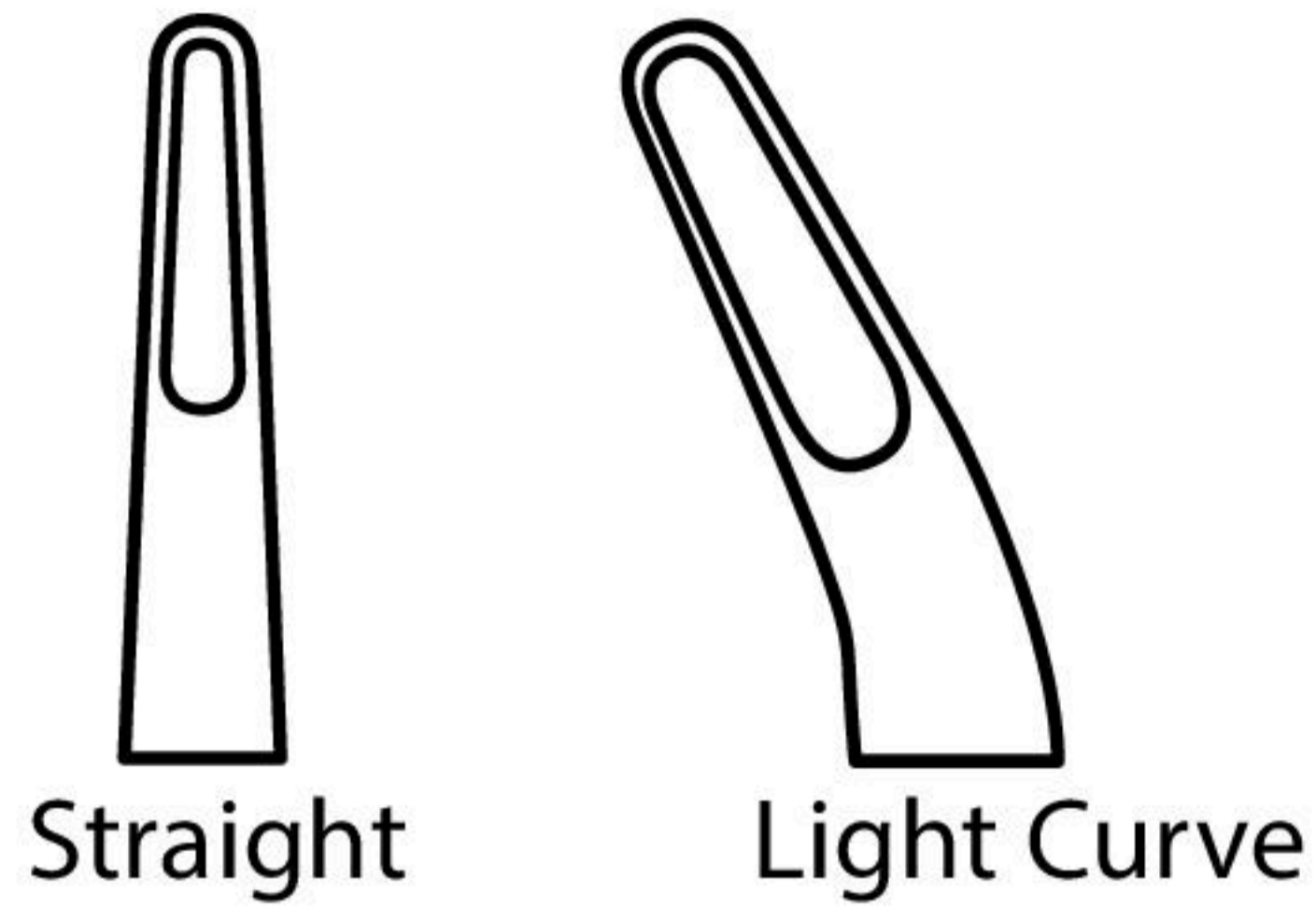

Straight	Light Curve	Bite Size
ORGT 1010-24	ORGT 1014-24	3mm
ORGT 1011-24	ORGT 1015-24	4mm
ORGT 1012-24	ORGT 1016-24	5mm
ORGT 1013-24	ORGT 1017-24	6mm

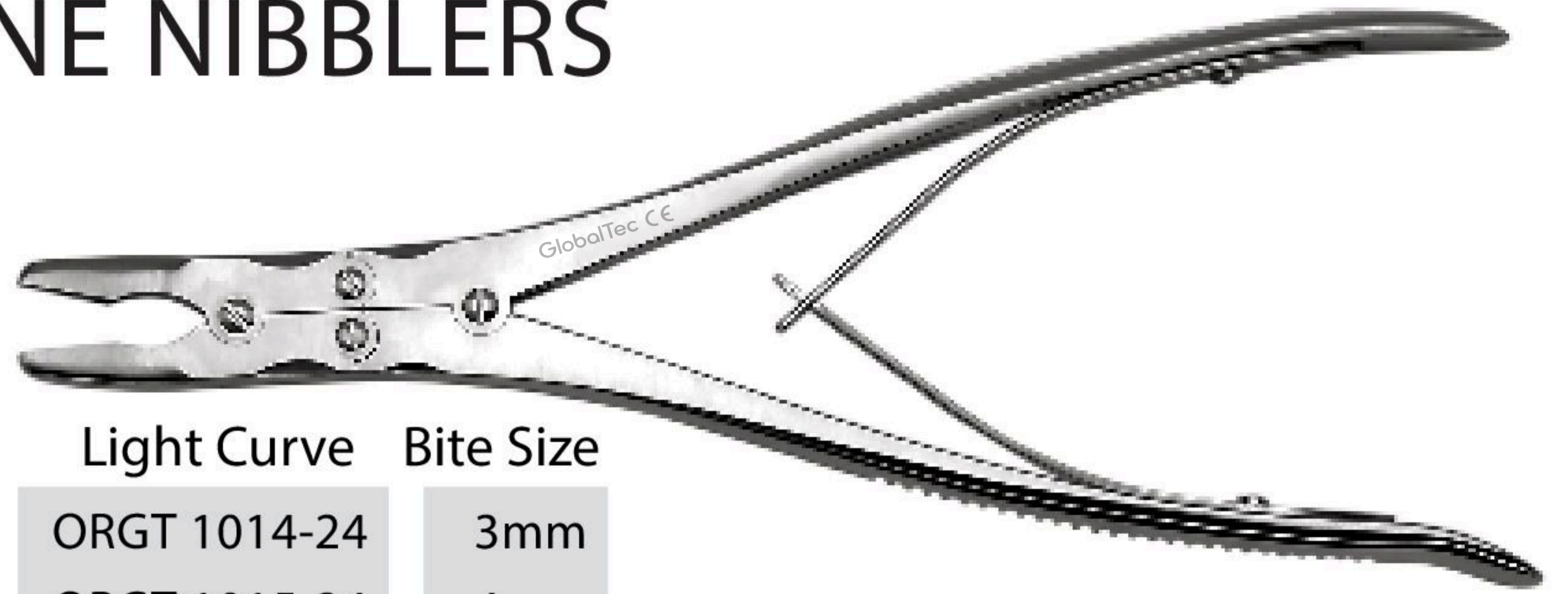

### Leksell Bone Nibbler

- 24cm/9½" Length
- Curved Action Angled

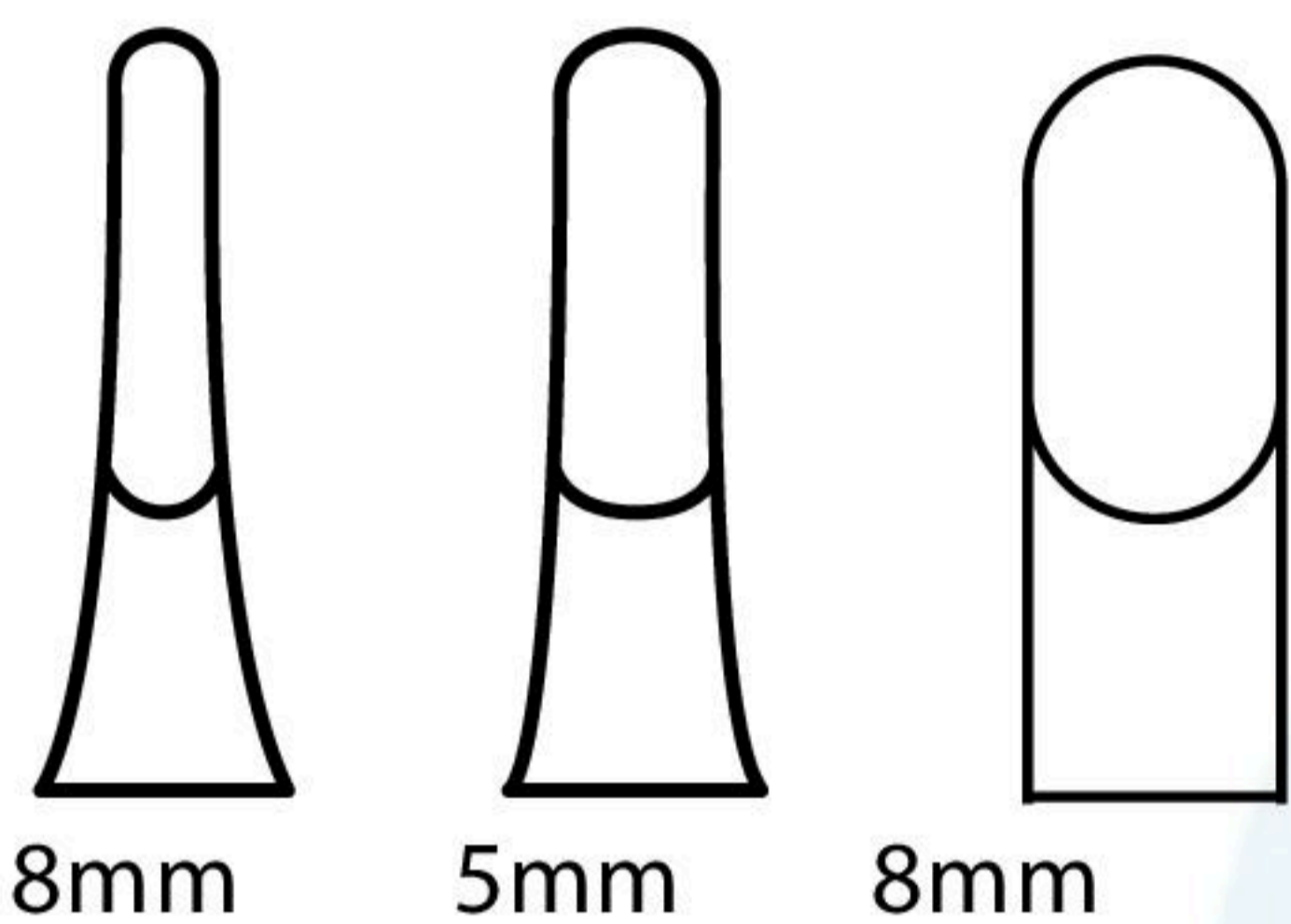

Angled Jaw	Bite Size
ORGT 1018-24	3mm
ORGT 1019-24	5mm
ORGT 1020-24	8mm



### Stille - Luer Bone Nibbler

- 22cm/8¾" Length
- Double Action

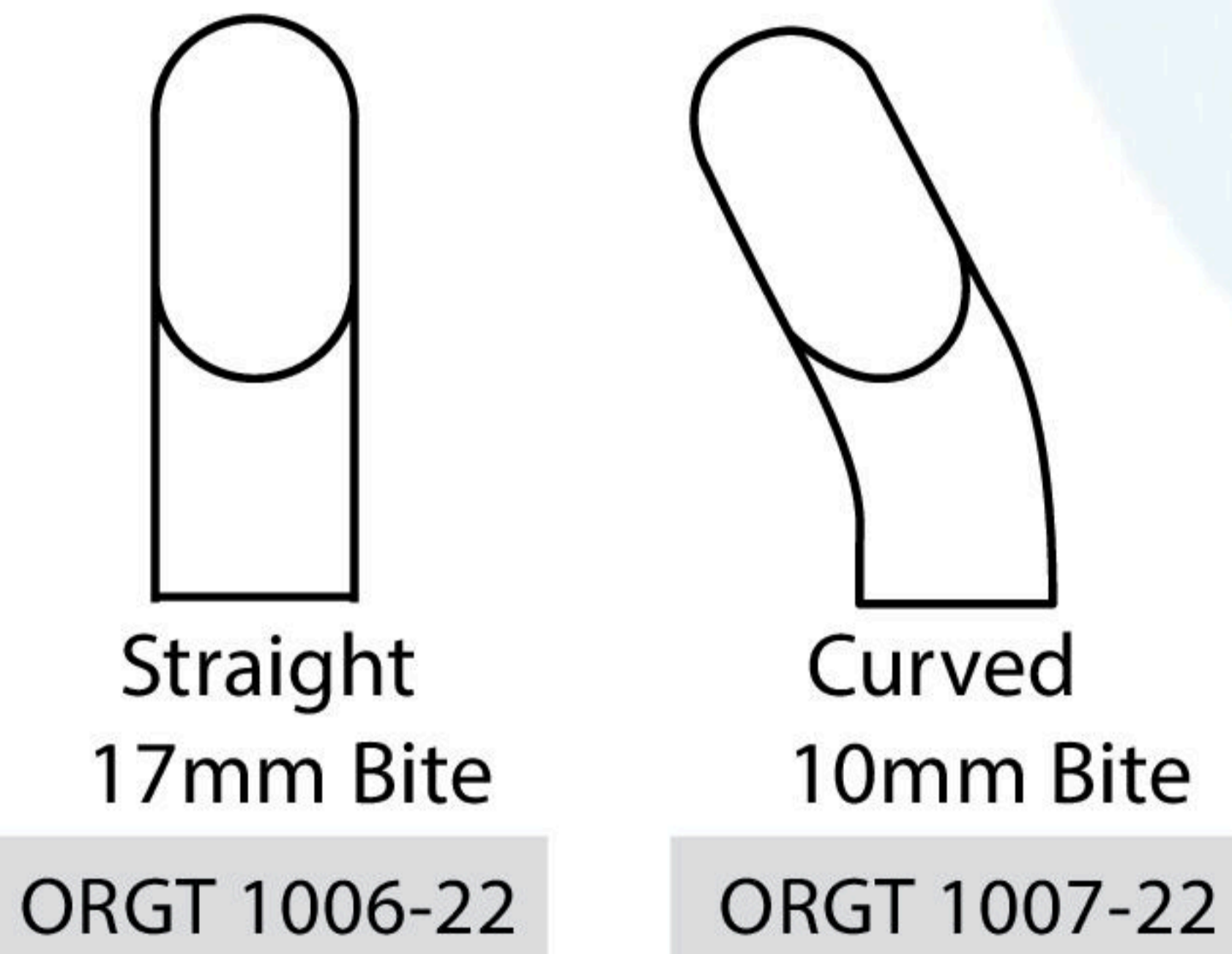

27cm/10½" Straight	27cm/10½" Curved
ORGT 1006-27	ORGT 1007-27

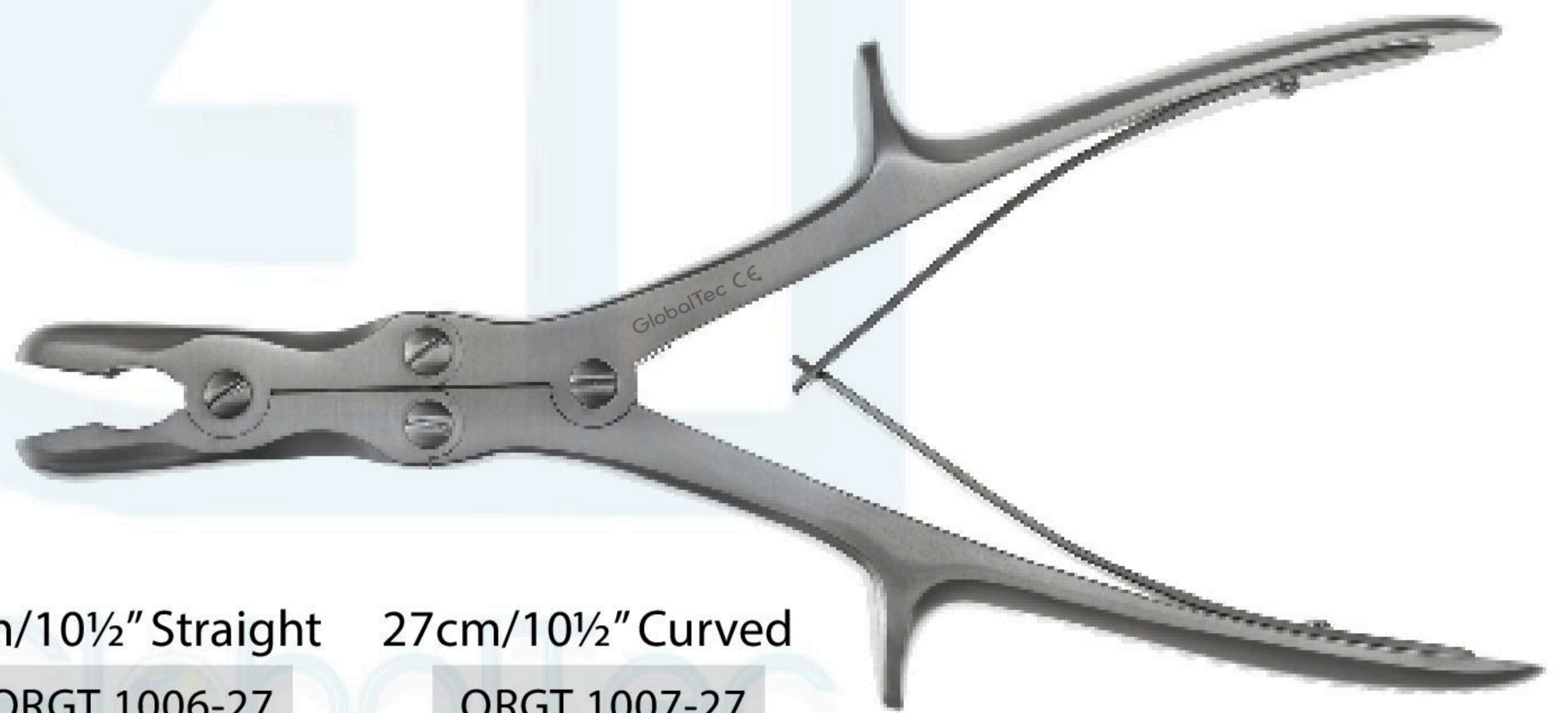

### Semb Bone Nibbler

- 26cm/10¼" Length
- Double Action

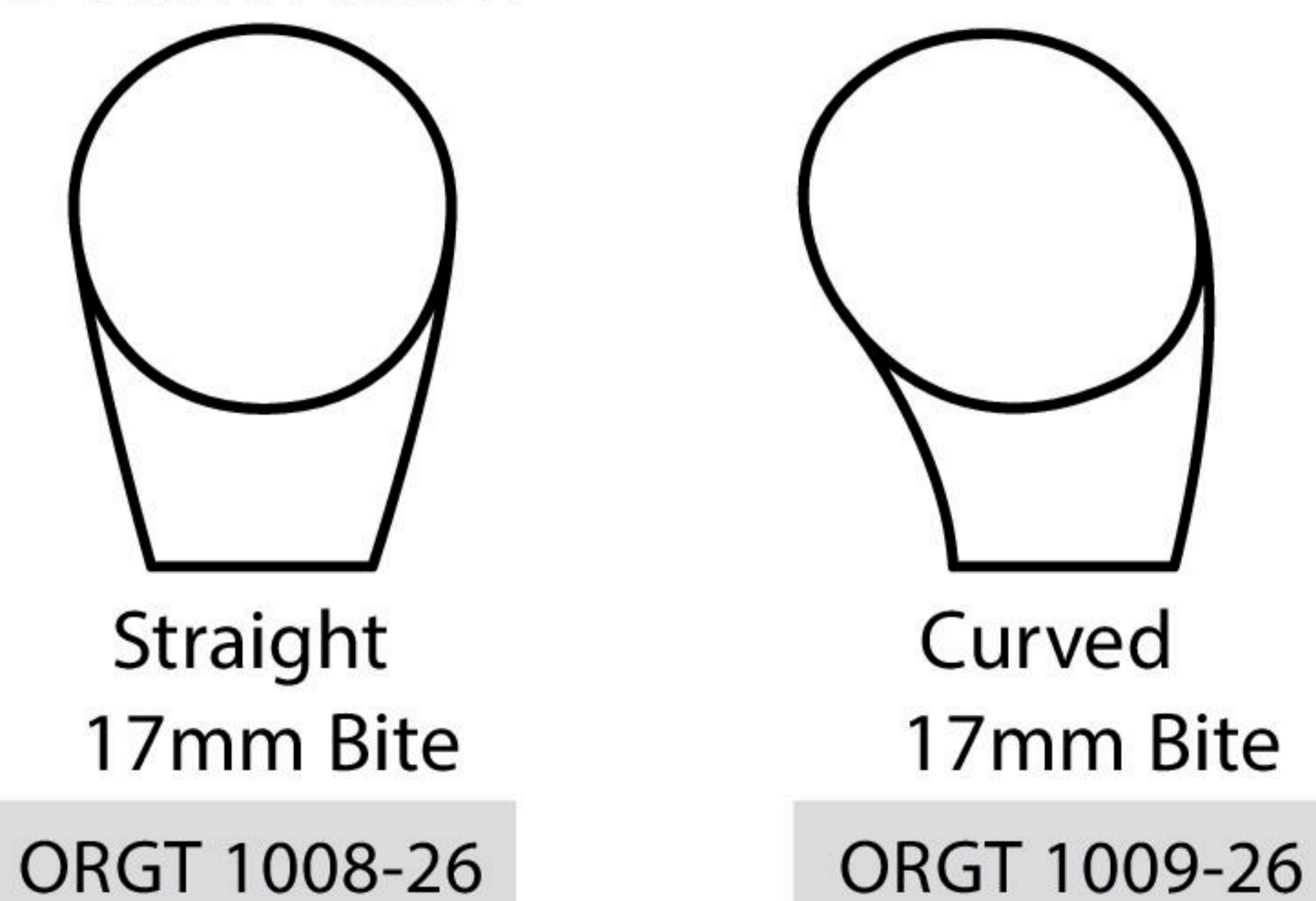

## BONE HOLDING FORCEPS

### Pattela Holdinh Forceps

- With smart Lock

ORGT 00363



### Frosch Bone Holding Forceps

- 18cm/7" Length
- Toothed/Serrated Jaws

ORGT 6141-18



### Two Pointed Reduction Clamp

- 14cm/5 1/5"

ORGT 5042-14

- 19cm/5 1/5"

ORGT 5042-19

- 23cm/9"

ORGT 5042-14



### Fergusson Bone Holding Forceps

- 20cm/8" Length
- Screw Joint

ORGT 6140-20



### Langenbeck Bone Holding Forceps

- 20cm/8 1/4" Length

ORGT 6144-21

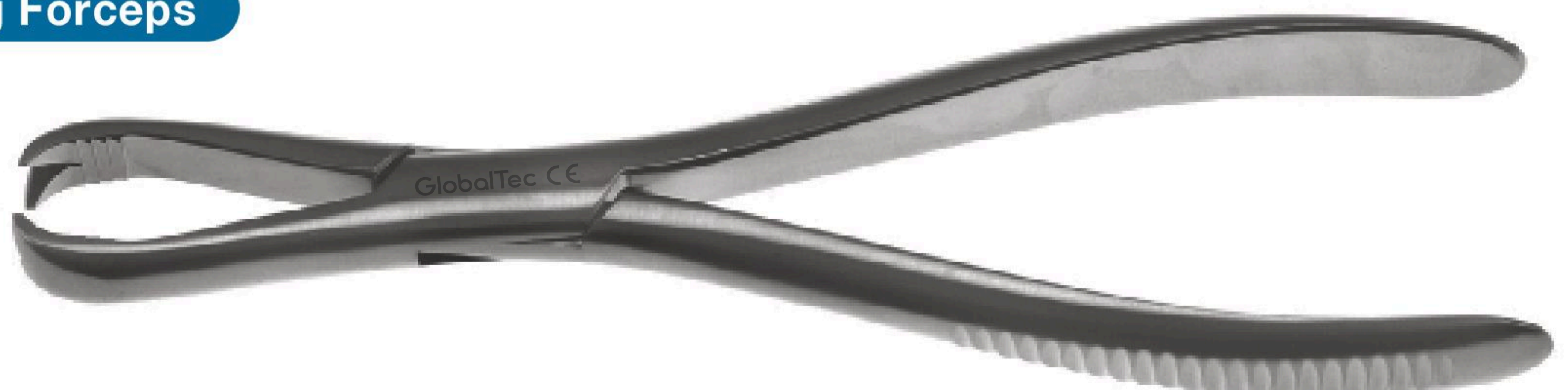

## BONE HOLDING FORCEPS

### Semb Bone Holding Forceps

- 19cm/7½" Length
- Angled to Side

ORGT 6147-18



### Hey Groves Bone Holding Forceps

- Screw Joints
- Serrated Jaws

ORGT 6145-20  
ORGT 6145-25  
ORGT 6145-30

Length

20CM/ 8"  
25.5CM/ 10"  
30.5CM/ 12"

Small  
Medium  
Large



### Verbrugge Bone Holding Forceps

ORGT 6150-25  
ORGT 6150-26  
ORGT 6150-27

Length

25CM/ 10"  
26CM/ 10½"  
27CM/ 11"

Small  
Medium  
Large



### Self Centering Bone Holding Forceps

ORGT 6149-16  
ORGT 6149-19  
ORGT 6149-22

16CM/ 6½"  
16CM/ 7½"  
22CM/ 8½"

ORGT 6149-24  
ORGT 6149-27  
ORGT 6149-29

24CM/ 9½"  
27CM/ 10½"  
29CM/ 11½"



## PELVIC REDUCTION INSTRUMENTS

### Pelvic Reduction Forceps

- 19cm/7½" Length
- Angled Small
- Pointed Ball Tips
- Speed Lock

ORGT 6151-19



### Pelvic Reduction Forceps

- 23cm/9" Length
- Angled Small
- Pointed Ball Tips
- Speed Lock

ORGT 6152-23



### Pelvic Reduction Forceps

- 25cm/10" Length
- Straight Large
- Pointed Ball Tips
- Speed Lock

ORGT 6153-25



### Pelvic Reduction Forceps

- 40cm/16" Length
- Pointed Ball Tips
- Speed Lock

ORGT 6154-40



## PELVIC REDUCTION INSTRUMENTS

### Pelvic Reduction Forceps

- 40cm/16" Length
- Pointed Ball Tips
- Speed Lock

ORGT 6155-40



### Asymetric Pelvic Reduction Forceps

- 40cm/16" Length

ORGT 6156-40



### Pelvic Reduction Forceps with Screws

- 34cm/13½" Length

ORGT 6157-40



### Spanish Bone Reduction Forceps

- 17cm/6½" Length

ORGT 5024-17

- 19cm/7½" Length

ORGT 5024-19

- 24cm/9½" Length

ORGT 5024-24



### Lowman Bone Holding Forceps

- 14cm/5½" Length

ORGT 6180-14

- 18cm/7" Length

ORGT 6180-18

- 20cm/8" Length

ORGT 6180-20



## RETRACTORS

### Meyerding Retractor

- 22cm/9" Length

	Blade Size
ORGT 5050-22	50mm x 16mm
ORGT 5050-22	70mm x 25mm
ORGT 5050-22	90mm x 50mm



### Langenbeck Retractor

- 21.5cm/8½" Length

	Blade Size	
ORGT 2522-06	22mm x 6mm	Small
ORGT 2545-13	45mm x 13mm	Medium
ORGT 2565-25	65mm x 25mm	Large
ORGT 2590-20	90mm x 20mm	Extra large

Customised sizes are available



### Volkman Retractor

- 21.5cm/8½" Length
- Semi Sharp Teeth

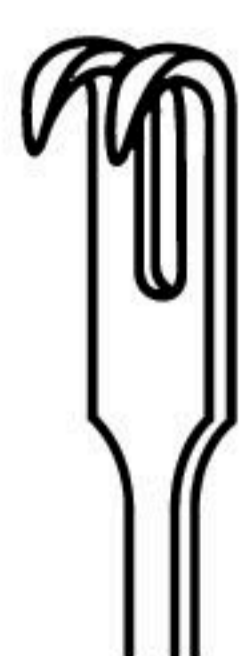

15 X 10mm  
2 Prong  
ORGT 209



15 X 15mm  
3 Prong  
ORGT 210



15 X 20mm  
4 Prong  
ORGT 211

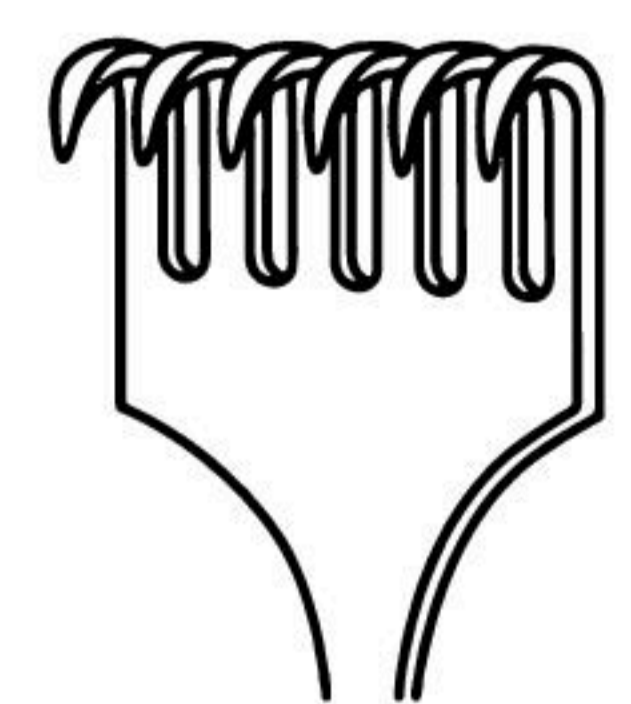

15 X 30mm  
6 Prong  
ORGT 211

## HIP RETRACTORS

**Charnley Initial Incision Retractor Set**

Frame Only

ORGT 4006-16

**Complete Set-Basic**

ORGT 4006-00

Consisting of:

- 1x Frame
- 1x Weight & Chain
- 1x Square Fitting Blade-50mm Depth
- 1x Round Fitting Blade-40mm Depth

**Complete Set-Extended**

ORGT 4006-05

Consisting of:

- 1x Frame
- 1x Weight & Chain
- 3x Square Fitting Blades:
  - 50mm Depth
  - 75mm Depth
  - 100mm Depth
- 3x Round Fitting Blades:
  - 40mm Depth
  - 75mm Depth
  - 100mm Depth

**Blade with Square Fitting**

ORGT 4006-50

StandardDepth 50mm

ORGT 4006-70

ExtraDepth 75mm

ORGT 4006-10

Extra, extra Depth 100mm

**Blade with Round Fitting**

ORGT 4007-40

StandardDepth 40mm

ORGT 4007-75

ExtraDepth 75mm

ORGT 4007-10

Extra, extra Depth 100mm

## RETRACTORS

### Weltlaner S/R Retractor

- 14cm/5½"Length
- 3 x 4 Blunt Prongs

ORGT 4002-14



### Travers S/R Retractor

- 20cm/8"Length
- 4 x 5 Blunt Prongs

ORGT 4004-20



### Nofolk and Norwich S/R Retractor

- 20cm/8"Length
- 4 x 5 Blunt Prongs

ORGT 4000-20



### Gelpi Laminectomy Retractor

- Sharp Prongs

ORGT 4030-16	18.5cm/7½"	30mm
ORGT 4050-16	19.5cm/7¾"	50mm
ORGT 4070-16	20cm/8"	70mm



## RETRACTORS

### Charnley Vertical Retractor

- 24.5cm/9½"Length
- 3 x 4 Sharp Prongs
- Blade Depth 22mm

ORGT 4007-24



### Beckman-Weltlaner/Cones Self Retaining Retractor

- 3 x 4 Prongs
- Jointed Arms



Blunt Prongs	Length	Depth	Sharp Prongs	Length	Depth
ORGT 4064-13	13cm/5"	15mm	ORGT 4063-13	13cm/5"	15mm
ORGT 4066-16	16cm/6½"	15mm	ORGT 4065-16	16cm/6½"	15mm
ORGT 4068-20	20cm/8"	20mm	ORGT 4067-20	20cm/8"	20mm
ORGT 4070-24	24cm/9½"	25mm	ORGT 4069-24	24cm/9½"	25mm

### Harvey Jackson Self Retaining Retractor

- 30.5cm/12"Length
- Blade Depth 45mm
- 3 x 3 Sharp Prongs

ORGT 4010-30

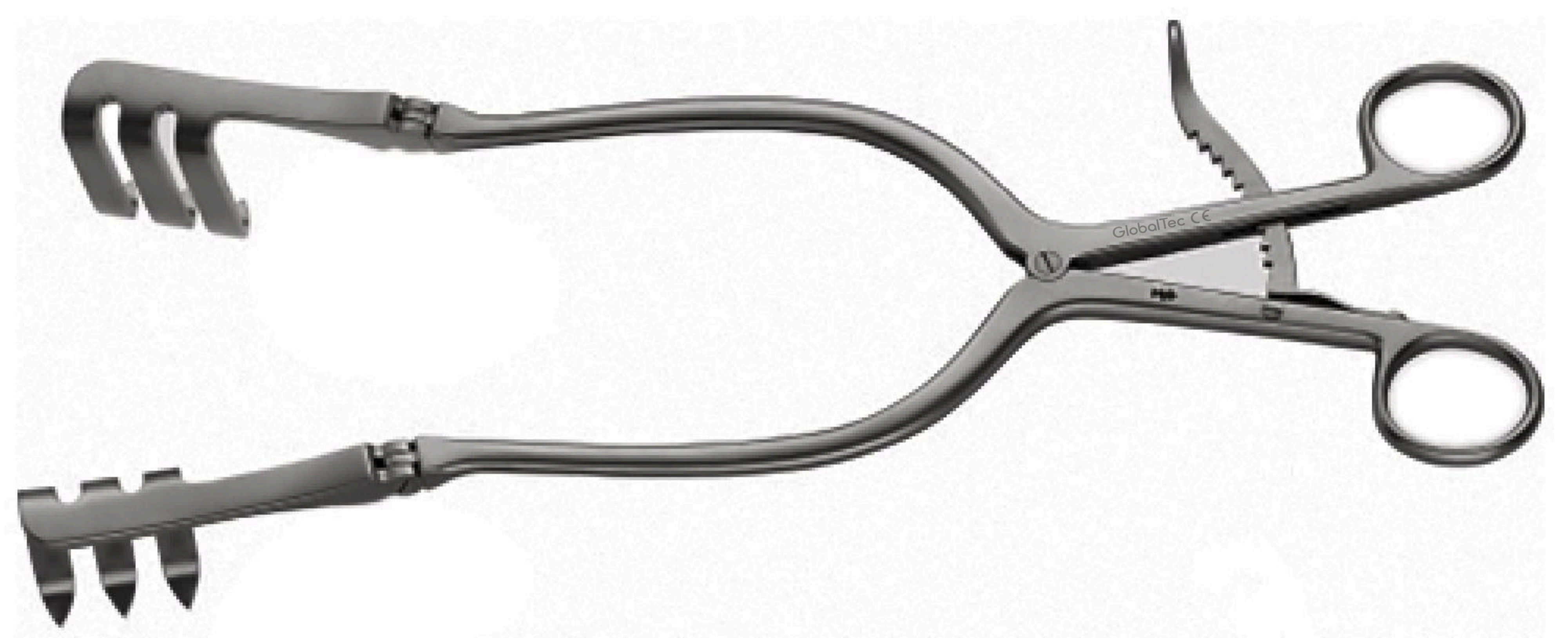

## RETRACTORS

### Charnley Vertical Retractor

- 24.5cm/9½" Length
- 3 x 4 Blunt Prongs
- Blade Depth 22mm

ORGT 4007-24



### Beckman-Weltlaner/Cones Self Retaining Retractor

- 3 x 4 Prongs
- Jointed Arms

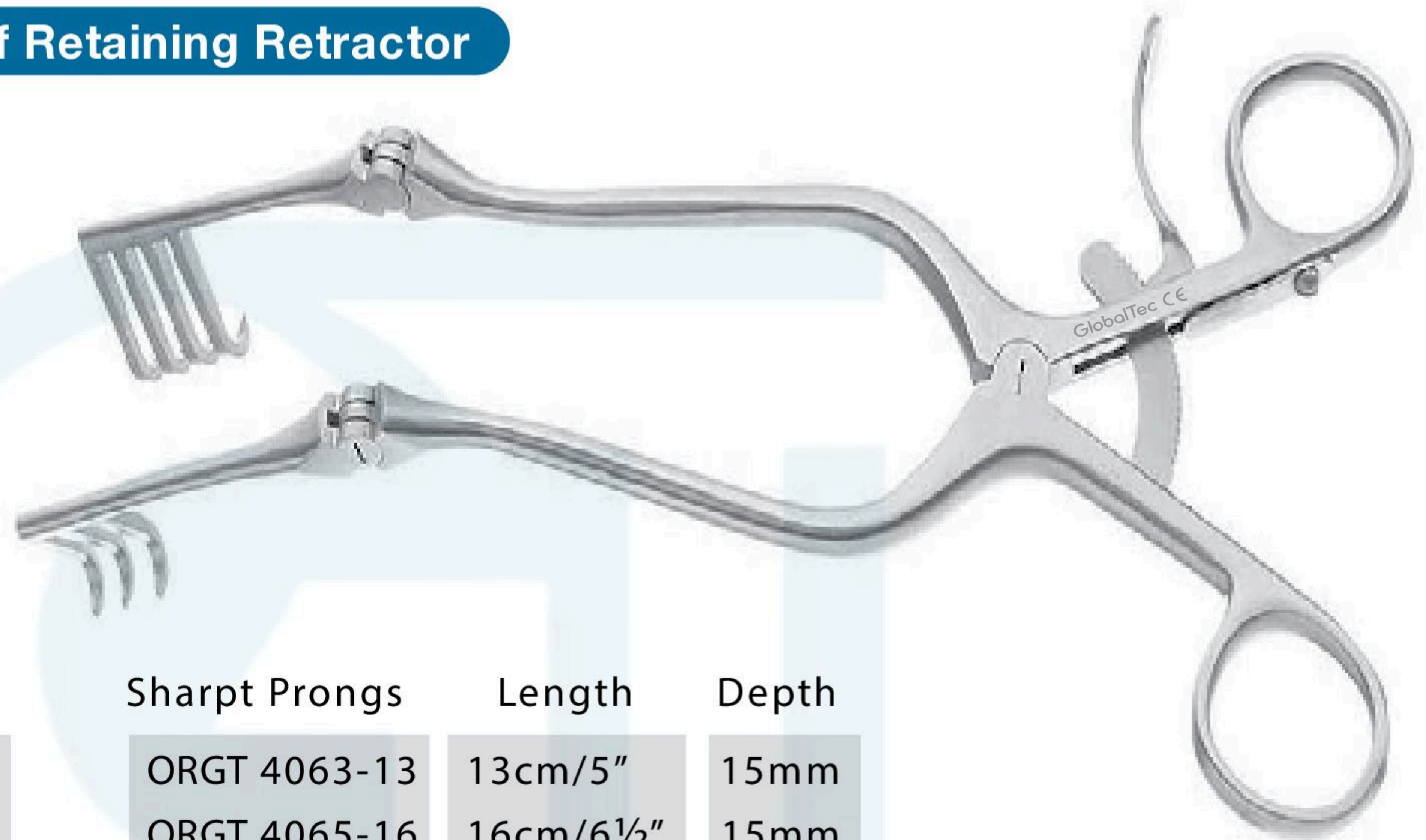

Blunt Prongs	Length	Depth	Sharpt Prongs	Length	Depth
ORGT 4064-13	13cm/5"	15mm	ORGT 4063-13	13cm/5"	15mm
ORGT 4066-16	16cm/6½"	15mm	ORGT 4065-16	16cm/6½"	15mm
ORGT 4068-20	20cm/8"	20mm	ORGT 4067-20	20cm/8"	20mm
ORGT 4070-24	24cm/9½"	25mm	ORGT 4069-24	24cm/9½"	25mm

### Harvey Jackson Self Retaining Retractor

- 30.5cm/12" Length
- Blade Depth 45mm
- 3 x 3 Sharp Prongs

ORGT 4010-30



## RETRACTORS

### Viper Hinged Scoliosis Retractor

- 30cm/11½"Length
- Sharp

#### Sharpt Prongs

ORGT 7248-38H	40mm
ORGT 7248-40H	70mm
ORGT 7248-50H	100mm

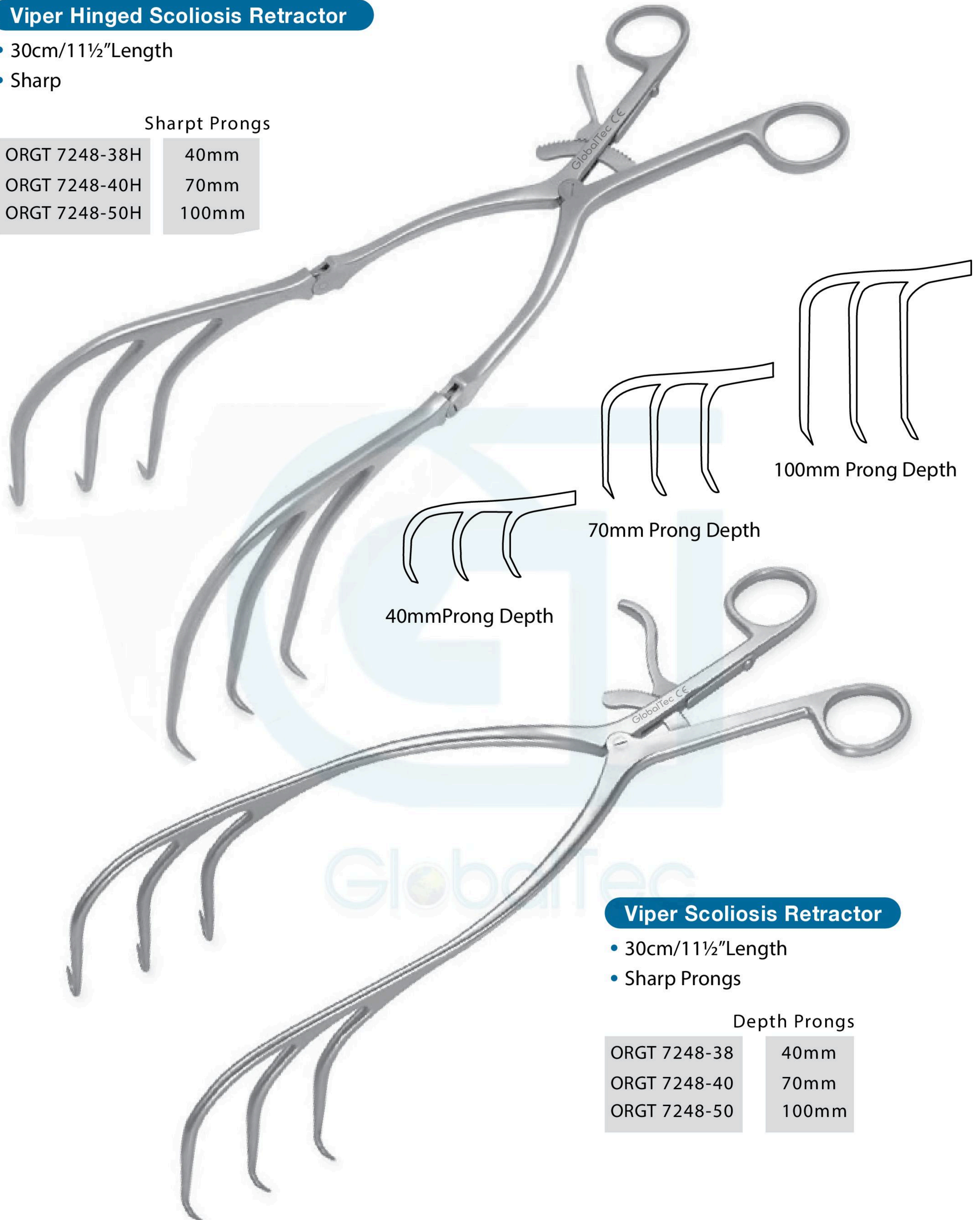

### Viper Scoliosis Retractor

- 30cm/11½"Length
- Sharp Prongs

#### Depth Prongs

ORGT 7248-38	40mm
ORGT 7248-40	70mm
ORGT 7248-50	100mm

## MALLETS

### Toffee Mallet

- 19cm/7½"Length
- Head Size 22mmø
- Weight 165g/6oz

ORGT 5808-21



### Ultra Fine Mallet

- 17cm/6½"Length
- Head Size 22mmø
- Weight 145g/5oz

ORGT 5801-17



### Heath Mallet

- 19cm/6½"Length
- Head Size 40mmø
- Weight 1020g/36oz

ORGT 5809-19

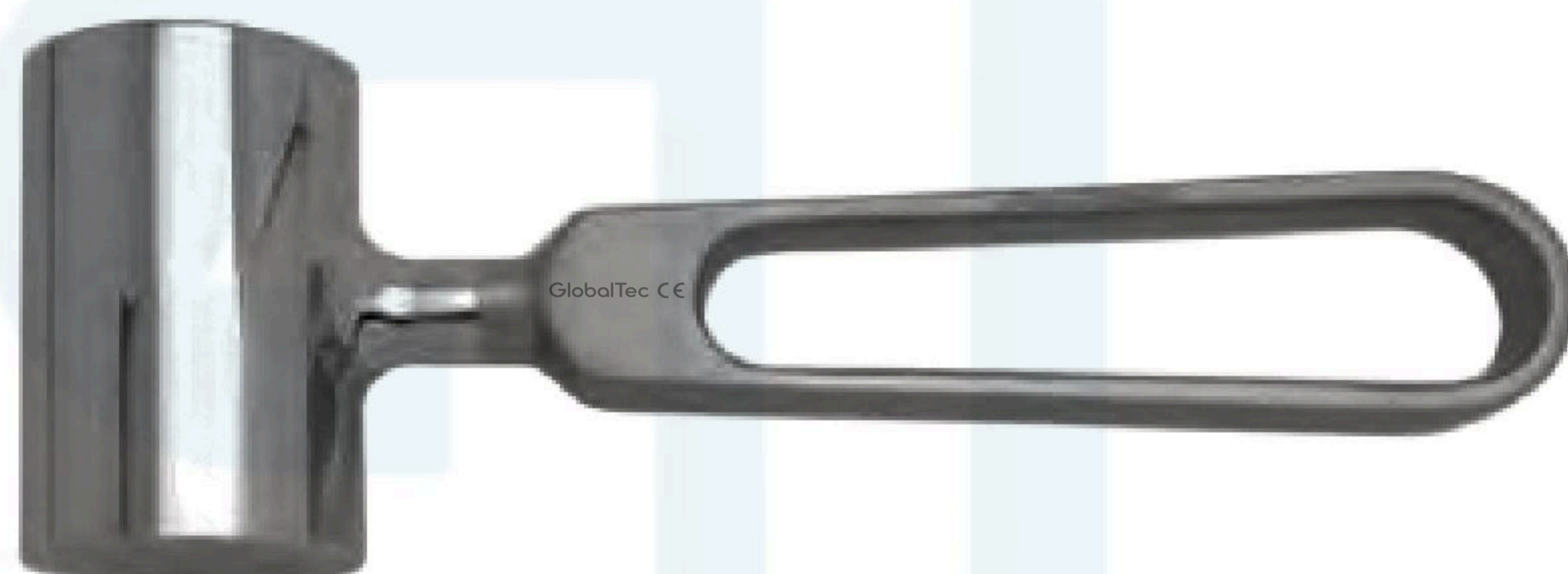

### JJ Mallet

- 23cm/9"Length
- Fibre Handle
- Head size 40 mm
- Weight 750g

ORGT 4750-24



- Fibre Handle
- Head size 38 mm
- Weight 650g

ORGT 3800-26

- Fibre Handle
- Head size 30 mm
- Weight 200g

ORGT 3810-20

## MALLETS

### London Splint Mallet

- 18cm/7" Length
- Head Size 30mmø
- Weight 450g/16.2oz

ORGT 5802-18



### Ombredanne Mallet

- 24cm/9½" Length
- Head Size 22mmø
- Weight 550g/20oz

ORGT 5806-24



### Mallet with Silicon Handle

- 24cm/9" Length
- Head Size 38 x 32mm
- Weight 400g

ORGT 3832-24



### Slotted Mallet

- 24cm/9" Length
- Head size 40 mm
- Weight 65

ORGT 4000-65



## OSTEOTOMES

### Mini-Lambotte Osteotome



12.5cm/5" Length	Width	17.78cm/7" Length	Width
ORGT 5205-02	2mm	ORGT 5207-02	2mm
ORGT 5205-03	3mm	ORGT 5207-03	3mm
ORGT 5205-04	4mm	ORGT 5207-04	4mm
ORGT 5205-06	6mm	ORGT 5207-06	6mm
ORGT 5205-08	8mm	ORGT 5207-08	8mm

### Lambotte Osteotome

• 25cm/9¾" Length



Straight	Width	Curved	Width
ORGT 7970-04	4mm	ORGT 7971-04	4mm
ORGT 7970-06	6mm	ORGT 7971-06	6mm
ORGT 7970-08	8mm	ORGT 7971-08	8mm
ORGT 7970-10	10mm	ORGT 7971-10	10mm
ORGT 7970-13	13mm	ORGT 7971-13	13mm
ORGT 7970-16	16mm	ORGT 7971-16	16mm
ORGT 7970-18	18mm	ORGT 7971-18	18mm
ORGT 7970-20	20mm	ORGT 7971-20	20mm
ORGT 7970-25	25mm	ORGT 7971-25	25mm
ORGT 7970-30	30mm	ORGT 7971-30	30mm

### Ultra Fine Osteotome

• 16cm/6¼" Length

	Width
ORGT 5230-02	2mm
ORGT 5230-03	4mm
ORGT 5230-04	6mm
ORGT 5230-08	8mm
ORGT 5230-10	10mm
ORGT 5230-12	12mm

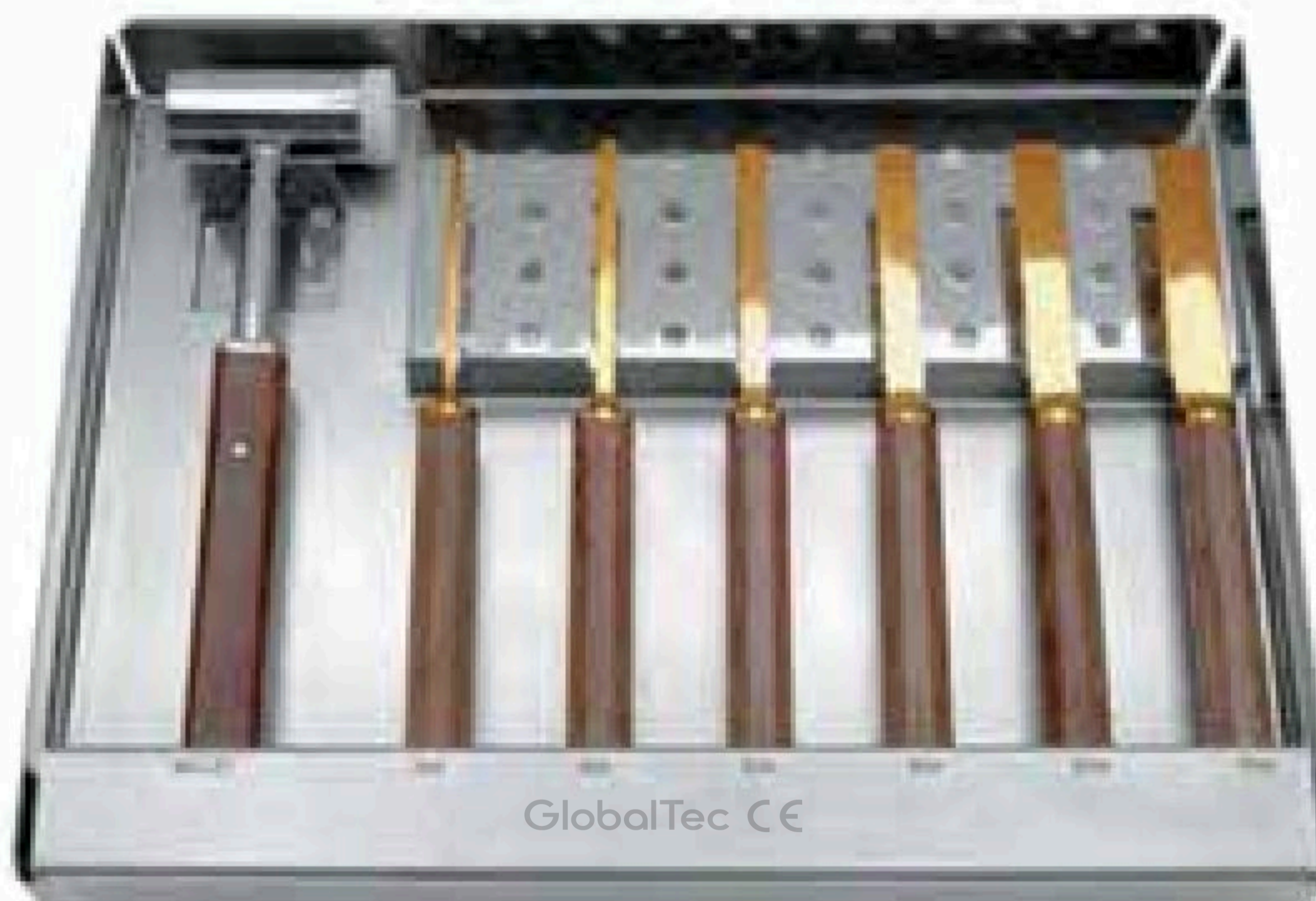
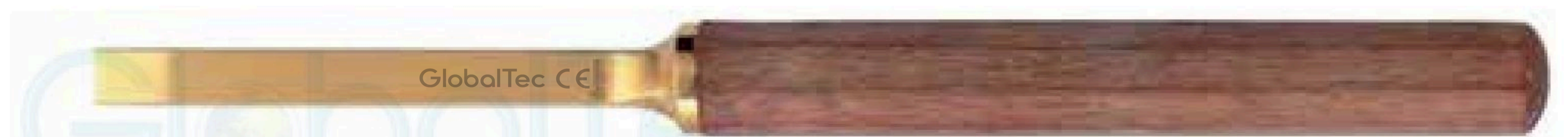

Set of 6 sizes: 2mm to 12mm complete with mallet in sterilising case

ORGT 5230-48

## OSTEOTOMES

### Mini-Stillle Osteotome

- 16cm/6¼" Length

Straight	Width
ORGT 7704-16	4mm
ORGT 7704-16	6mm
ORGT 7704-16	8mm



### Stillle (Swedish) Osteotome

- 20cm/8" Length

Straight	Width	Curved	Width
ORGT 7708-06	6mm	ORGT 7908-06	6mm
ORGT 7708-08	8mm	ORGT 7908-08	8mm
ORGT 7708-10	10mm	ORGT 7908-10	10mm
ORGT 7708-12	12mm	ORGT 7908-12	12mm
ORGT 7708-15	15mm	ORGT 7908-15	15mm
ORGT 7708-20	20mm	ORGT 7908-20	20mm
ORGT 7708-25	25mm	ORGT 7908-25	25mm
ORGT 7708-30	30mm	ORGT 7908-30	30mm



### Hibbs Osteotome width thin Blade

- 20cm/8" Length
- Extra thin Blade

Straight	Width	Curved	Width
ORGT 7808-04	4mm	ORGT 7908-04	4mm
ORGT 7808-06	6mm	ORGT 7908-06	6mm
ORGT 7808-08	8mm	ORGT 7908-08	8mm
ORGT 7808-10	10mm	ORGT 7908-10	10mm
ORGT 7808-12	12mm	ORGT 7908-12	12mm
ORGT 7808-15	15mm	ORGT 7908-15	15mm
ORGT 7808-20	20mm	ORGT 7908-20	20mm
ORGT 7808-25	25mm	ORGT 7908-25	25mm
ORGT 7808-30	30mm	ORGT 7908-30	30mm



### Smith Petersen Osteome

- 20cm/8" Length

	Width
ORGT 7610-20	10mm
ORGT 7615-20	15mm
ORGT 7620-20	20mm
ORGT 7625-20	25mm
ORGT 7630-20	30mm

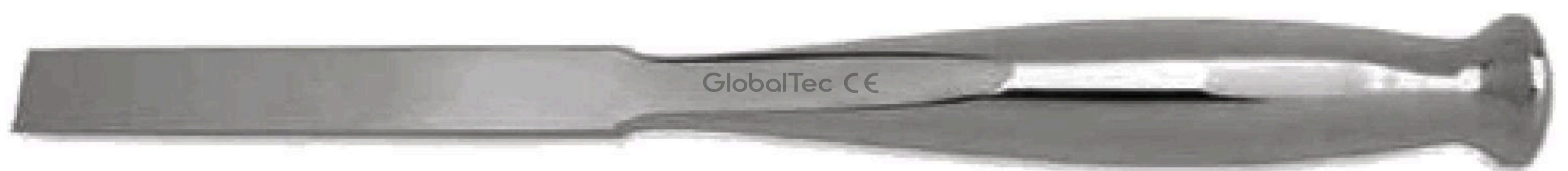

## OSTEOTOMES

### Alliance Osteotome

- 25cm/10" Length

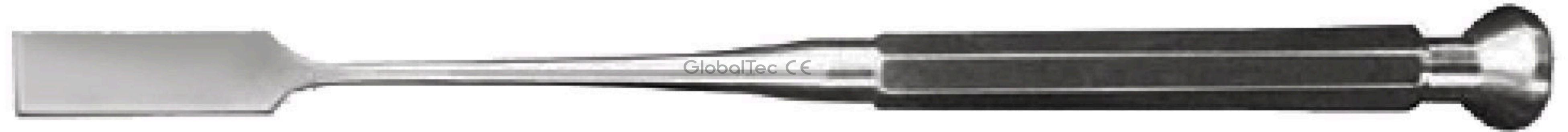

Straight	Width	Curved	Width
ORGT 6009-05	5mm	ORGT 6109-05	5mm
ORGT 6009-10	10mm	ORGT 6109-10	10mm
ORGT 6009-15	15mm	ORGT 6109-15	15mm
ORGT 6009-20	20mm	ORGT 6109-20	20mm
ORGT 6009-25	25mm	ORGT 6109-25	25mm

### Lexer Osteotome

- 20cm/8" Length
- Fibre Handle



	Width
ORGT 7207-22	7mm
ORGT 7210-22	10mm
ORGT 7215-22	15mm
ORGT 7220-22	20mm
ORGT7225-22	25mm

### Dahmen Osteotome

- 30cm/12" Length
- Fibre Handle



	Width		Straight	Width		Angled	Width
	5mm		ORGT 7105-30	5mm		ORGT 7305-30	5mm
	10mm		ORGT 7105-30	10mm		ORGT 7305-30	10mm
	15mm		ORGT 7105-30	15mm		ORGT 7305-30	15mm
	20mm		ORGT 7105-30	20mm		ORGT 7305-30	0mm
	25mm		ORGT 7105-30	25mm		ORGT 7305-30	25mm
	30mm		ORGT 7105-30	30mm		ORGT 7305-30	30mm

## OSTEOTOMES & GOUGES

### Box Chisel

- For Preparation of the Proximal Femur
- 23cm/9" Length
- 23cm width x 4 mm

ORGT 17803

- 25cm/10" Length
- 28 cm width x 6 mm

ORGT 17803



### Pelvic Osteotome

- 30cm/12" Length
- Tufnol Handle
- Angled Shaft

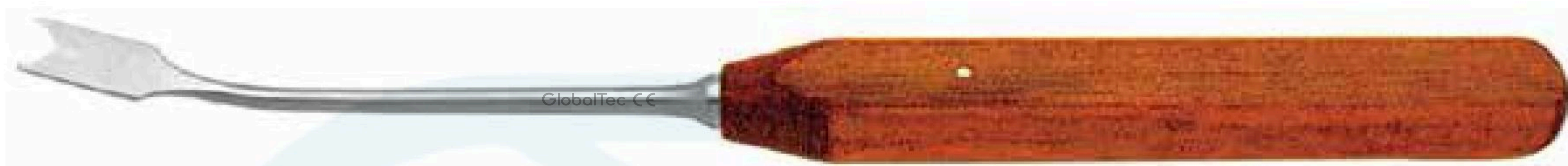

15mm Width

ORGT 7015-30

20mm Width

ORO 7020-30

### Chisel with Inchangeable Blades

- 20cm/8" Length
- Tufnol Handle
- Very Thin Blades

ORGT 0790-20

Complete set with 4 Blades\* & Key

Blade Width

ORGT 0792-05

5mm\*

ORGT 0793-08

8mm\*

ORGT 0793-10

10mm\*

ORGT 0793-12

12mm\*

ORGT 0793-15

15mm\*

ORGT 0793-25

25mm\*



### Capener Lamina Gouge

- 23cm/9" Length
- Cranked Shaft

Width

ORGT 6506-23

6mm

ORGT 6508-23

8mm

ORGT 6511-23

11mm

ORGT 6516-23

16mm



## BONE CURETTES

### Volkman Curette

- 22cm/8¾" Length
- Double Ended



	Size
ORGT 8401-22	Small
ORGT 8402-22	Medium
ORGT 8403-22	Large

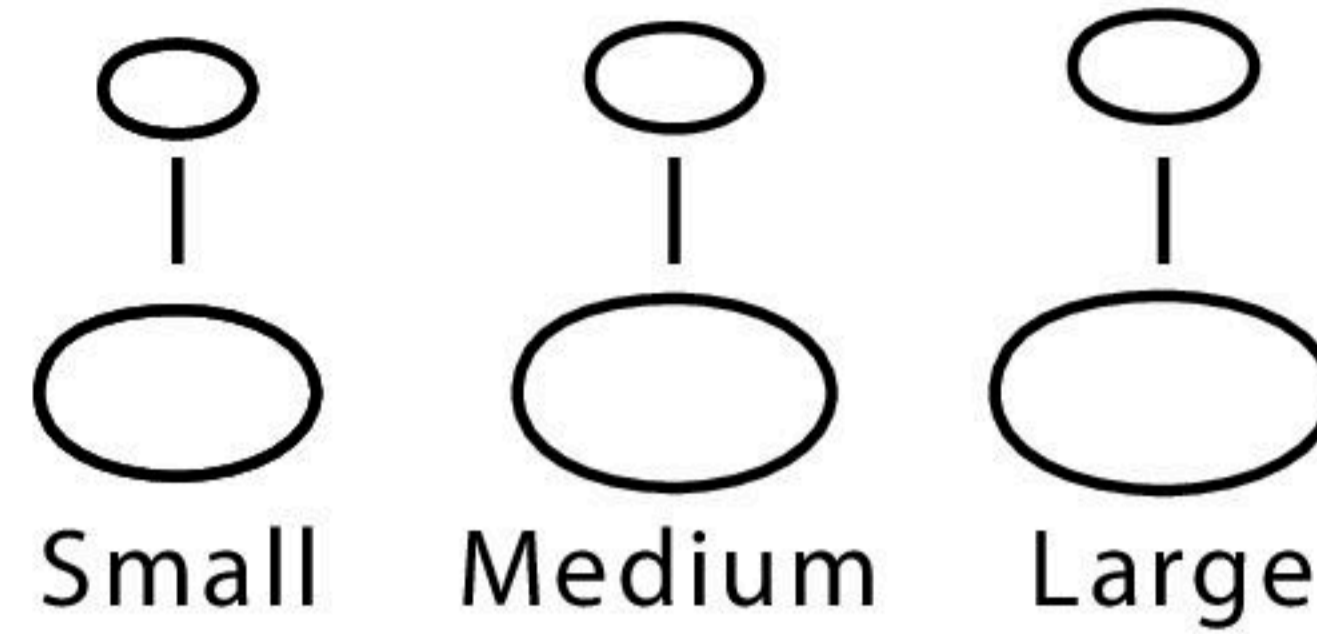

### Muller Curette with Tufnol handle

- 27cm/9½" Length
- Tufnol Handle

\*Illustrated



Small Cup 9mm ø

ORGT 8411-27

Medium Cup 13mm ø\*

ORGT 8412-27

Large Cup 27mm ø\*

ORGT 8413-27

### Charnley Bone Curette

- 37cm/15" Length
- T - Handle

\*Illustrated



Small Cup 14mm ø

ORGT 8421-37

Medium Cup 17mm ø\*

ORGT 8422-37

Large Cup 22mm ø\*

ORGT 8423-37

### Charnley Ring Curette

- 37cm/15" Length
- Double Sided
- Serrated Cutting Edge
- T - Handle



ORGT 8430-37

## HIP REVISION INSTRUMENTS

### Cup Extraction Chisel

- 32cm/12½" Length
- Curved 7mm Tip
- Metal Strike Plate
- Tufnol Handle

ORGT 6507-32



### Bayonet Gouge

- 32cm/12½" Length
- Metal Strike Plate
- Tufnol Handle
- 8mm Width

ORGT 6508-32



### Swan Necked Gouge

- 28.5cm/11" Length
- 25mm Width

ORH 6525-28



### Cement Gouge

- 34.5cm/13½" Length

9mm Width

ORGT 6509-34



11mm Width

ORGT 6511-34

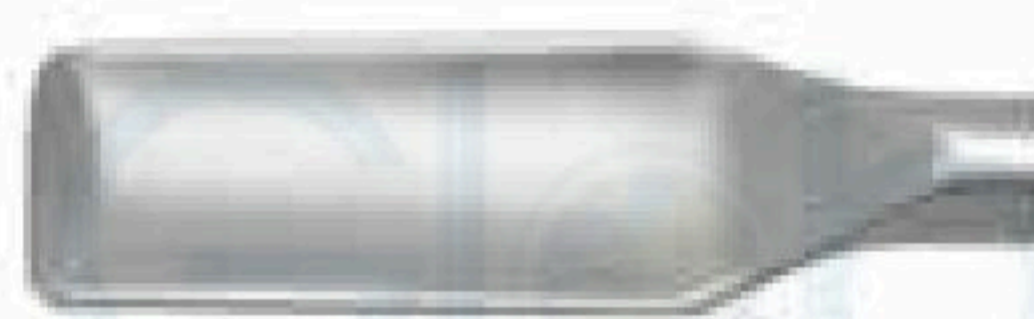

### Cement Chisel Angled 15°

- 35cm/14" Length
- 9 mm Tip

ORGT 6109-35



## HIP REVISION INSTRUMENTS

### Cement Osteotome

- 30cm/12" Length
- Tufnol Handle with Strike Plate

	Width
ORGT 6105-30	5mm
ORGT 6107-30	7mm
ORGT 6110-30	10mm



### Cement Splitting Osteotome

- 30cm/12" Length
- Tufnol Handle with Strike Plate
- Guarded Blade

	Width
ORGT 6205-30	5mm
ORGT 6210-30	10mm



### Straight Splitting Gouge

- 30cm/12" Length
- Tufnol Handle with Strike Plate

	Width
ORGT 6305-30	5mm
ORGT 6307-30	7mm
ORGT 6310-30	10mm



### Bayonet Cement Rasp

- 54cm/20½" Length
- Tufnol Handle

\*Illustrated

ORGT 6100-52



ORGT 6100-52

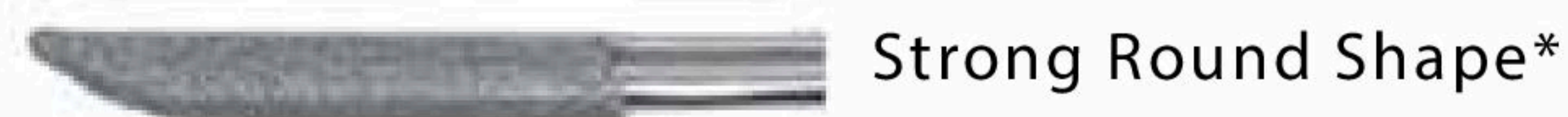

ORGT 6100-52



## HIP REVISION INSTRUMENTS

### Bayonet Cement Chisel

- 40cm/15¾" Length
- Tufnol Handle with Strike Plate

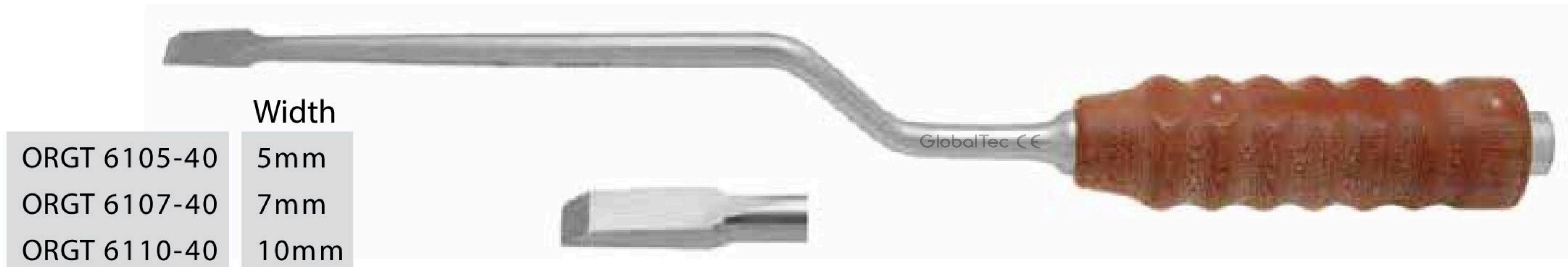

### Bayonet Cement Splitting Osteotome

- 40cm/15¾" Length
- Tufnol Handle with Strike Plate
- Guarded Blade

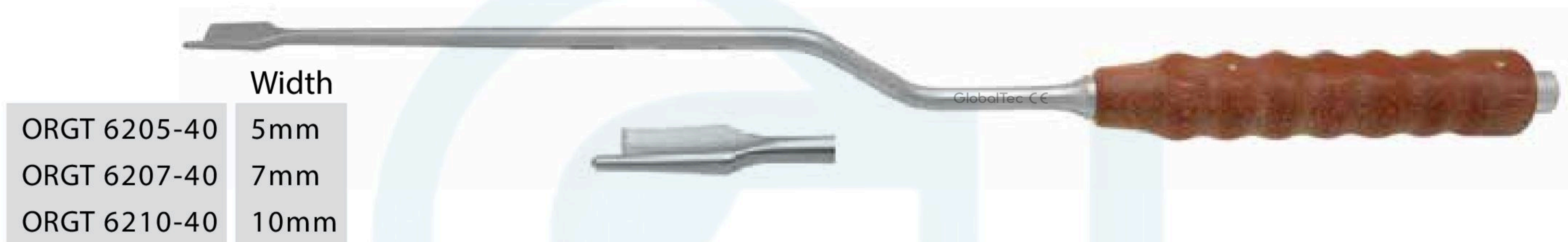

### Bayonet Cement Gouge

- 40cm/15¾" Length
- Tufnol Handle with Strike Plate



### Bayonet Cement Gouge

- 40cm/15¾" Length
- Tufnol Handle with Strike Plate



## HIP REVISION INSTRUMENTS

### Malleable Cement Probe

- 38cm/15" Length
- For probing the Femur

ORGT 6900-38



### Cement Plug Extractor

- 48cm/19" Length
- T- Handle
- For Extraction of Cement Plug

ORGT 6807-48

Thread Dia.

7mm

ORGT 6809-48

9mm

ORGT 6811-48

11mm

Used with a Slotted Mallet



### Retrograde Cement Chisel

- 50cm/19¾" Length
- Tufnol T- Handle
- Strike Plate

ORGT 6805-50

Width

5mm

ORGT 8507-50

7mm

ORGT 6810-50

10mm



### Slotted Mallet

ORH 6850-00

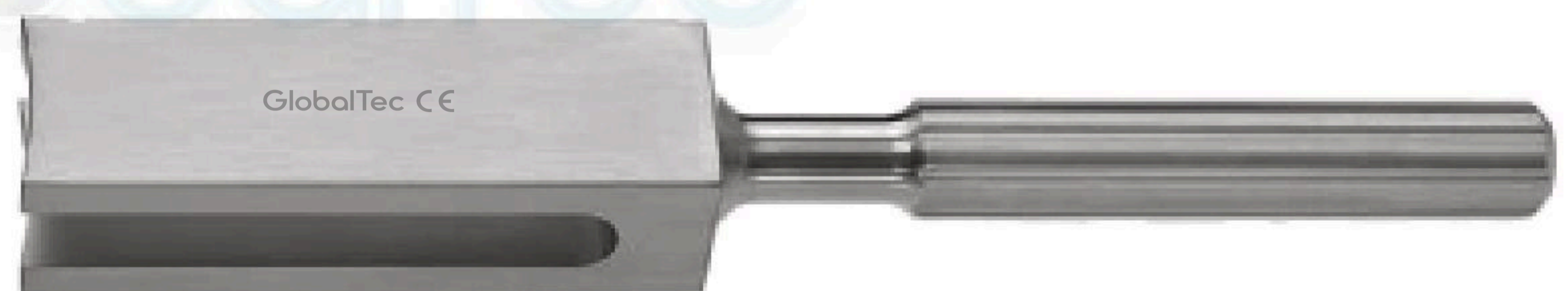

### Cement Extraction Hook

- 34.5cm/14" Length

ORGT 6905-34

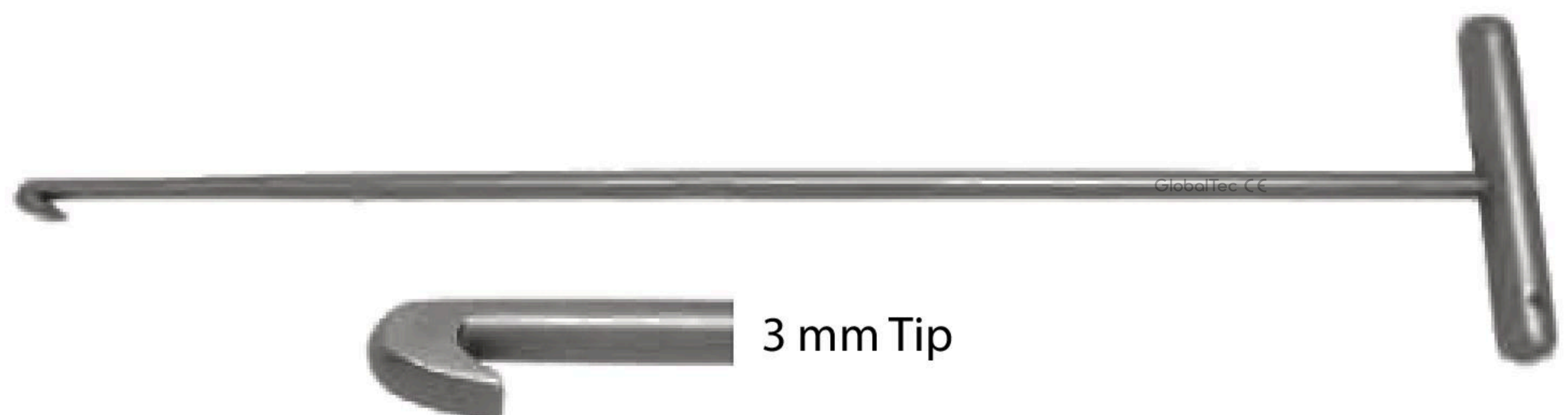

3 mm Tip

## HIP REVISION INSTRUMENTS

### Cement Twist Drill Long

40cm/15¾" Length



	Diameter
ORGT 1400-06	6mm
ORGT 1400-08	8mm
ORGT 1400-10	10mm

### Fine Cement Duckbill Grasping Forceps

- 35cm/14" Length
- Fine jaws

ORGT 6901-35



### Heavy Cement Grasping Forceps

- 26cm/10" Shaft Length
- Serrated jaws 6mm Width

ORGT 6902-26



## HIP REVISION INSTRUMENTS

### Femoral Head Extractor

- 23cm/9" Length
- Tufnol-Handle

ORGT 6916-23



### Moore femoral head Extractor

- 20.5cm/8" Length
- Metal Handle

ORGT 6914 -20



### Joint Capsule Clamp

- 21cm/8¼" Shaft Length
- 25mm jaw length

ORGT 6995 - 21



### Joint Capsule Scissors

- 25cm/19¾" Shaft Length
- Angled Blades

ORGT 6910 - 25



## HIP JOINT INSTRUMENTS

### Femoral Head Impactor

- 20cm/8" Length
- Nylon Head



ORGT 6918-20



### McGoey Bone Punch

- Double Ended

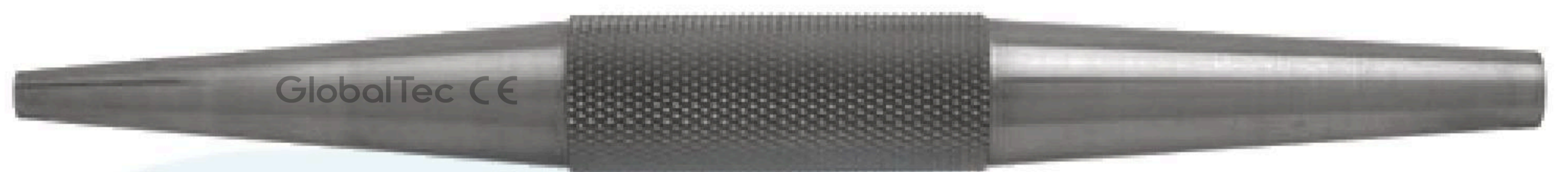

\*Illustrated

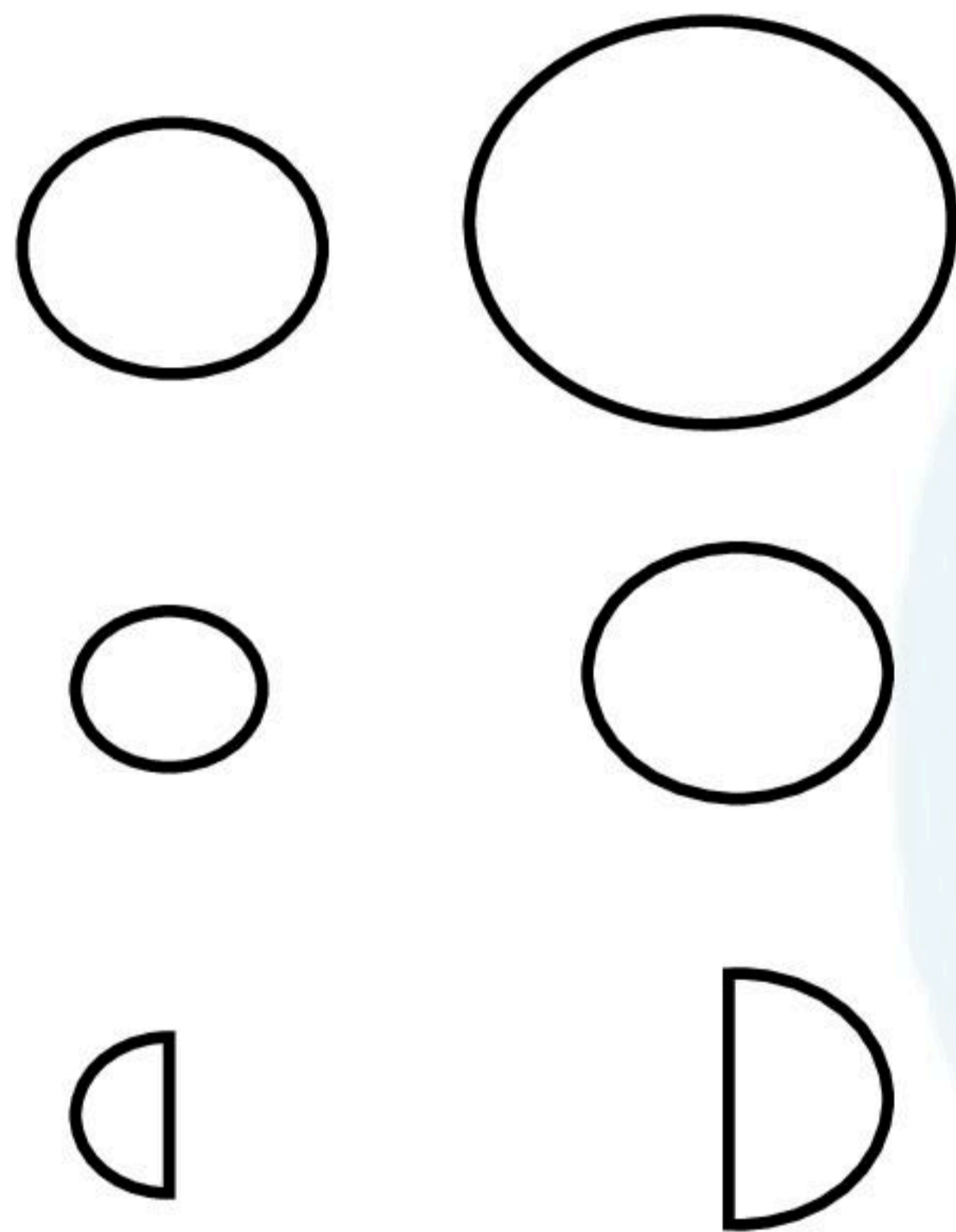

No 1. 13mm x 19mmø

ORGT6913-19 Large Size

No 2. 6mm x 10mmø

ORGT6906-19 \*Small Size

No 3. 6mm x 13mmø  
with Flats

ORGT6906-19

### Harding Cement Restrictor

- 33.5cm/13¾" Length
- Guarded Shaft



ORGT 6920-33

### Formoral Pusher

- Square Ended

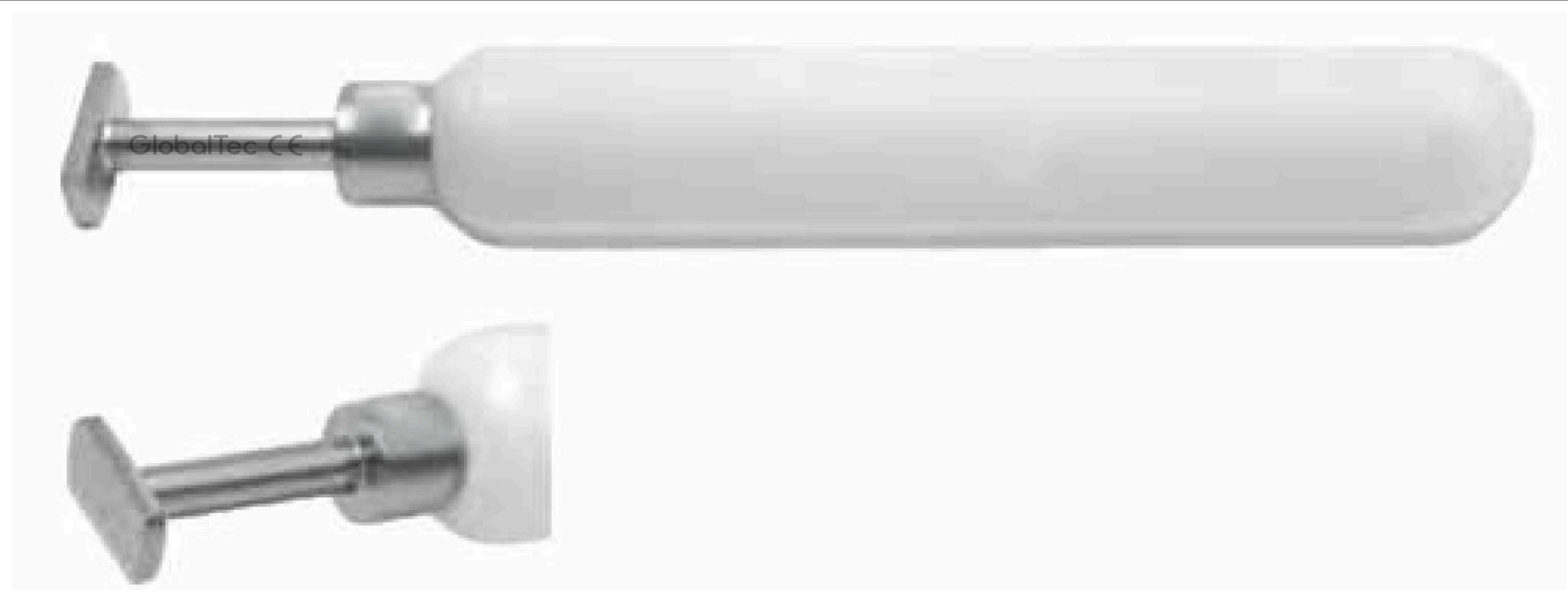

ORGT 6925-20

## PLIERS & WIRE CUTTERS

### Multi Purpose Pliers

- 20cm/8" Length

ORGT 00802

- 17cm/7" Length

ORGT 00801



### Long Nose Pliers

- 15cm/6" Length

ORGT 00142



### Dolphin Nose Pliers

- 20cm/7" Length

ORGT 00143

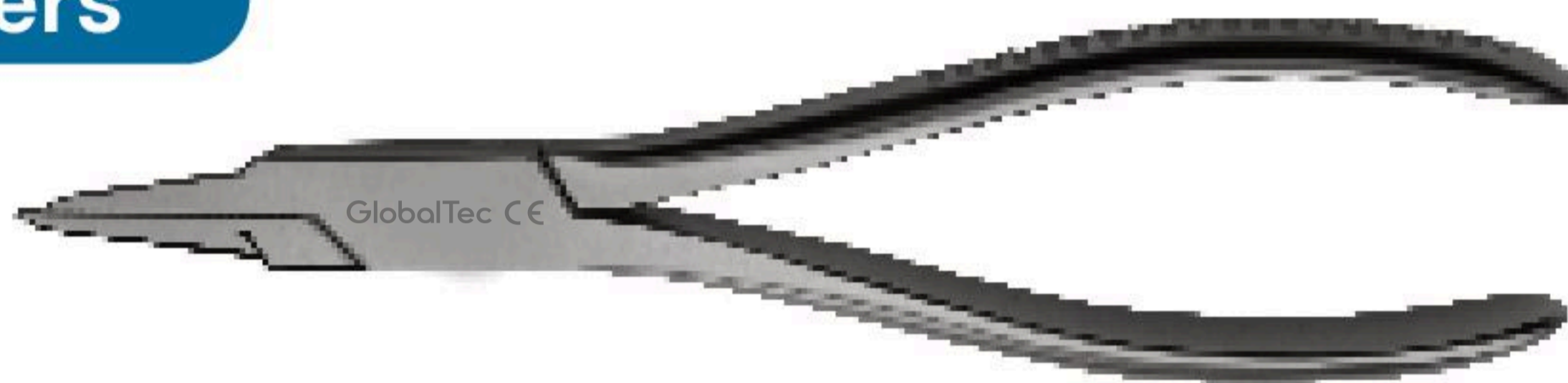

### Slim & Square Ended Wire Pliers

- 19cm/7½" Length

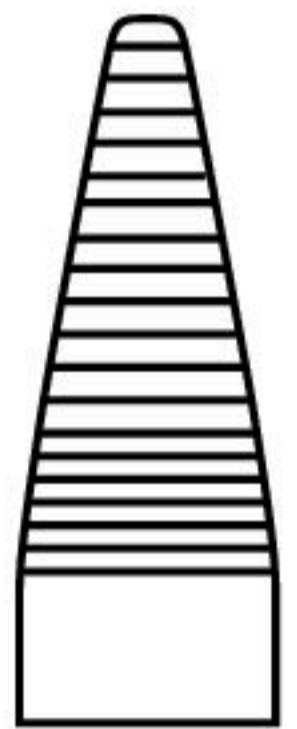

Slim Nose

ORGT 7645-19

Serrated Jaw

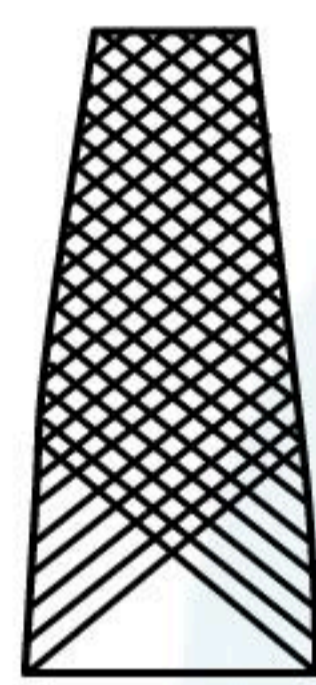

Square Ended\*

ORGT 7645-19



### Pliers for Damaged Screws

- 20cm/8" Length

ORGT 00329



### Muller Claus Wire Pullers

- 18cm/7" Length
- Double Action
- Tungsten Jaws

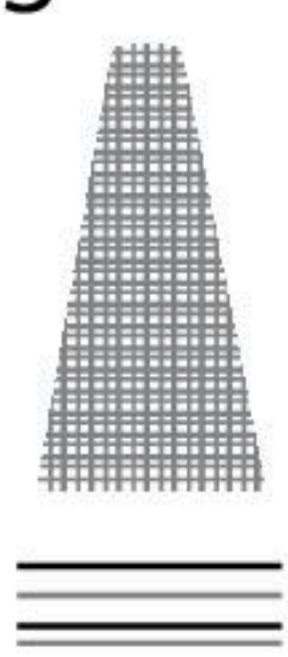

2mm Jaws

8-818E18

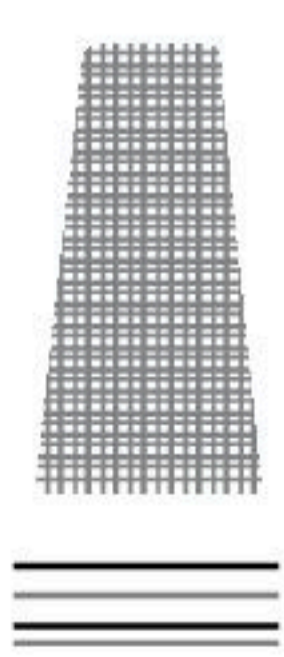

4mm Jaws

8-820E18

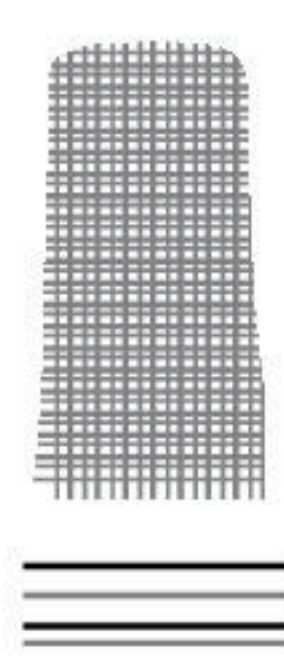

6mm Jaws

8-821E18



## PLIERS & WIRE CUTTERS

### Muller Claus Wire Cutters

- 16cm/6" Length
- Tungsten Carbide Edge
- Cuts Wire up to 1.6mm  $\varnothing$

8-810E16



### Muller Claus Wire Cutters

- Tungsten Carbide Edges

8-810E18

- 19cm/7½" Length
- Cuts Wire up to 2mm  $\varnothing$

8-800E22

- 22cm/8¾" Length
- Cuts Wire up to 3mm  $\varnothing$



### End Wire Cutters

- 18cm/7" Length
- Tungsten Carbide Edge
- Cuts wire up to 1.7mm  $\varnothing$

8-816E18



### Bolt Cutters with Dismantable Arms

- Max.cap 6.3mm Pins



200-500-585

Must be used in conjunction with a rod holder. Ordering Code: 200-675-200

## WIRE CUTTERS

### Combined Wire Cutters & Pliers

- 18cm/7" Length
- Suitable for wire up to 1.6mm  $\varnothing$
- Parallel closing Jaws

200-512-185



### Wire Cutters with T/C jaws

- 24cm/9½" Length
- Double Action
- Cuts plates & wire up to 2.7mm  $\varnothing$

ORGT 7644-24



### Drona K Y Cutter

- 20cm/8" Length
- Cutting inserts are T/C and can be replaced
- Cuts wire up to 3mm  $\varnothing$

ORGT 00377



## LOCKING PLIERS

### Needle Nosed Locking Pliers

- 18cm/7" Length
- Suitable for wire up to 1.6mmø
- Parallel closing Jaws



200-514-220	22cm/8¾"	Small
200-515-250	25cm/9¾"	Medium
200-516-300	30cm/11¾"	Large

\*A very useful instrument for orthopaedic surgery allowing the surgeon to securely clamp on to wires and implants.

### Slap Hammer Attachment Combined



Code	Length	Weight
200-400-350	35cm/13¾"	400g
200-515-250	25cm/13¾"	700g

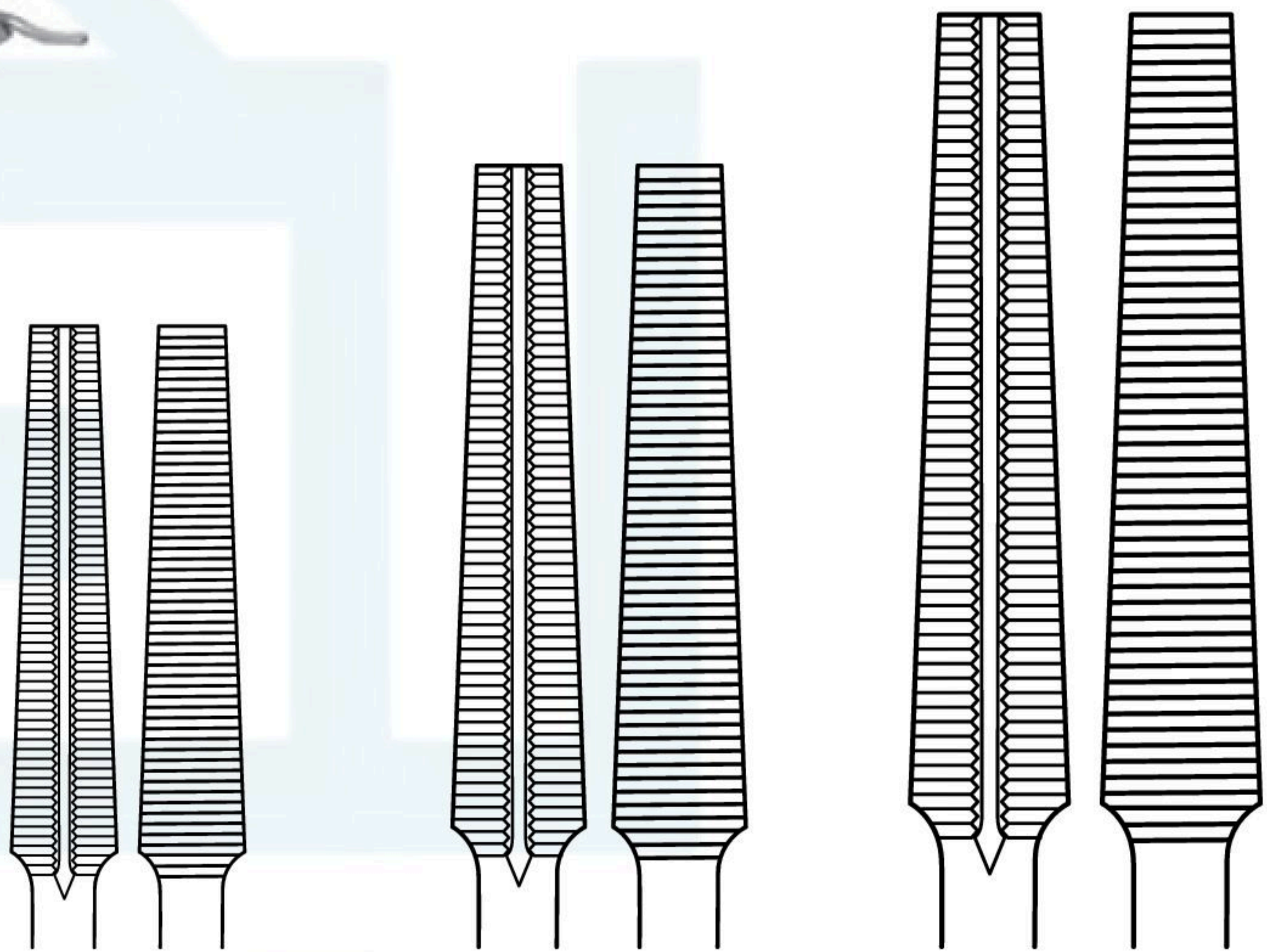

22cm/8¾" Small    25cm/9¾" Medium    30cm/11¾" Large

### Global Orthopaedic Locking Pliers

Slap Hammer Attachment

Code	Length	
ORGT 00339	18cm/7"	Small
ORGT 00338	28cm/11"	Large



### Slap Hammer Attachment

Code	Length	Weight
ORGT 00339-00	25cm/10"	400g
ORGT 00338-00	35cm/13"	700g



## PIN INTRODUCERS

### Kirschner Wire Introducing T-Handle

- 12cm/4¾" Length
- 1.6mm ø wires

ORGT 5015-12



### Steinmann Pin Introducer T-Handle

- 14mm-5½mm ø Pins
- With jacobs Chuck & Key

ORGT 5502-14



### Steinmann Pin Introducer T-Handle

- 14mm-5½mm ø Pins
- 0.7mm-6mm ø Pins
- Universal chuck

ORGT 5507-14



### Raindrop K-Wire Holder

- A Chuckless K-wire holder for 0.5 to 2.5mm K-Wires

ORGT 00410



## MISC

### Bone Mill

- Table Mounted with Crank Handle

ORGT 6001-00

For Grinding Bone Chips used for Bone Graft Procedures



### Wire Passing Guide

- 21cm/8¼" Length

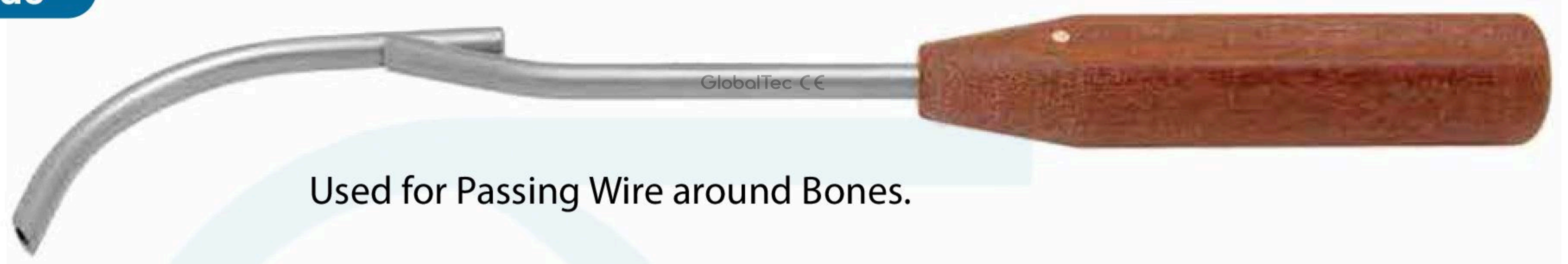

Used for Passing Wire around Bones.

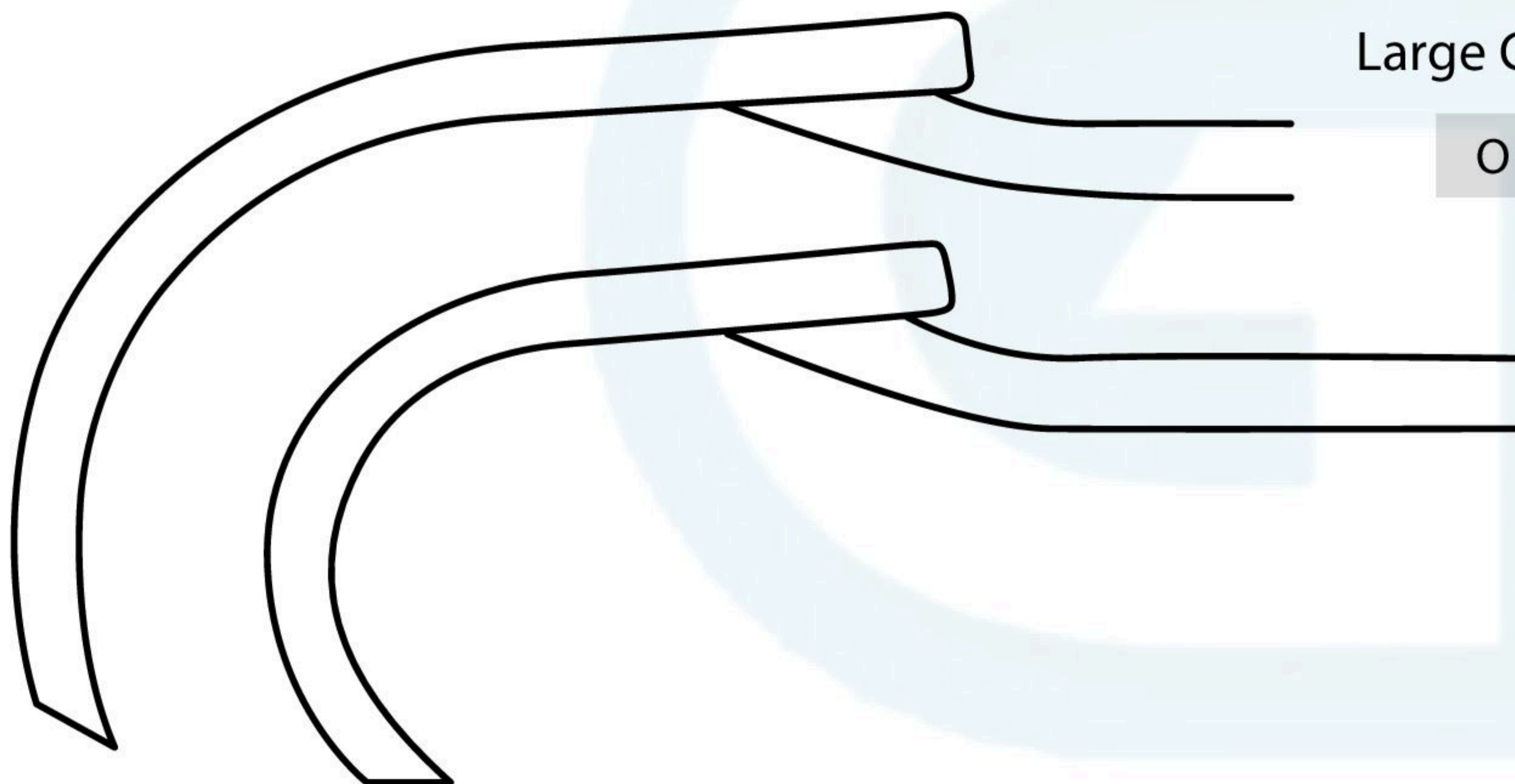

Large Curve 70mm ø

ORGT 6105-21

Small Curve 70mm ø

ORGT 6104-21

### Bone AWI

- Straight with eye

	Diameter	Length
ORGT 5602-12	2.0mm	125mm
ORGT 5602-13	2.4mm	130mm
ORGT 5602-14	2.8mm	145mm
ORGT 5602-15	3.2mm	160mm
ORGT 5602-16	3.6mm	165mm
ORGT 5602-17	4.0mm	175mm



## SCREWDRIVERS

### Slotted Head

- 17cm/6¾" Length
- For Head Screws 2.7mm - 4.0mm

ORGT 7014-17

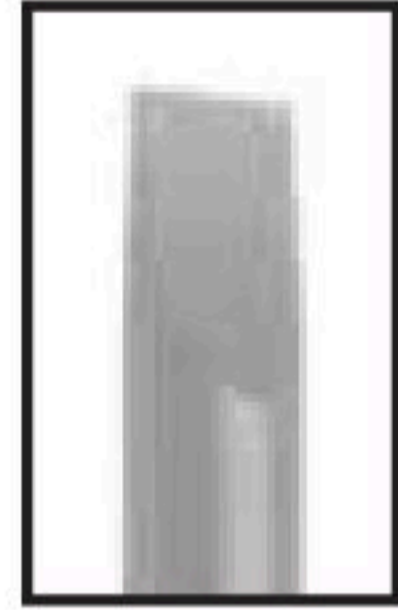

### Long Slotted Head

- 25cm/10" Length
- For Head Screws 2.7mm - 4.0mm

ORGT 7014-25

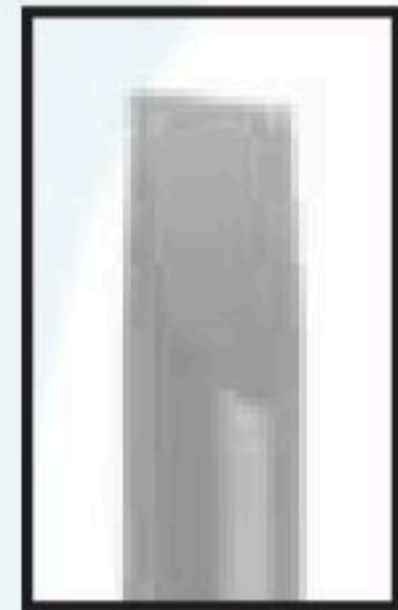

### Phillips Head

- 25cm/10" Length
- For Small Phillips Head Screws 6mm

ORGT 7015-25

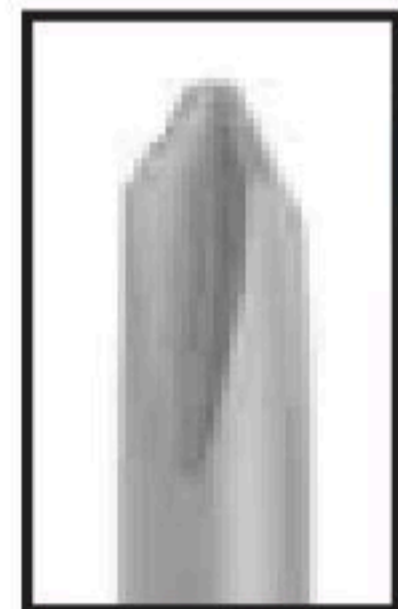

### Cross Slotted Head

- 25cm/10" Length
- For Cross Slot Screws 6mm

ORGT 7016-25

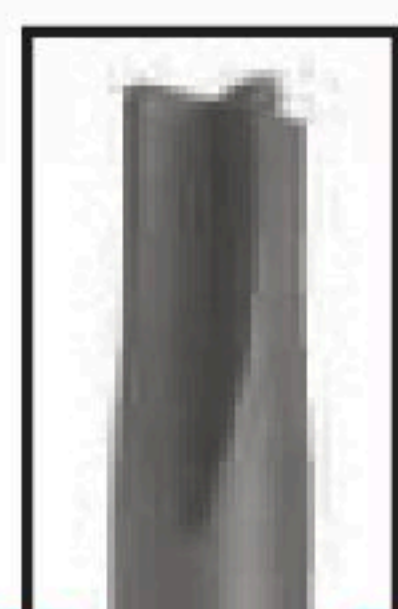

## SCREWDRIVERS

### Hexagonal Head

- 25cm/10" Length
- For hexagonal head screws 2.7mm - 4.0mm



### Screwdriver Handle

- To fit shaft with quick lock attachment

ORGT 7020-02



### Screwdriver Handle Small

- To fit shaft with quick lock attachment

ORGT 7020-01



### Shaft with Quick Lock Fitting

- Hexagonal tip



Shaft      Diameter

ORGT 7020-0      2.5mm

ORGT 7020-0      3.5mm

## DISSECTORS

### Howarth Elevator

- 21.5cm/8½"Length



ORGT 9207-21

### MacDonald Elevator/Dissector



Size

ORGT 7105-19	19cm/7½"
ORGT 9206-23	23mm

### Watson Cheyne Dissector



Length

ORGT 7203-18	18cm/7"
ORGT 9203-23	23mm/9"
ORGT 9203-25	25.5mm/10"

### Freers Elevator/Dissector

- 18.5cm/7¼"Length



ORGT 9202-18

### Swedish Dissector

- 18.cm/7"Length

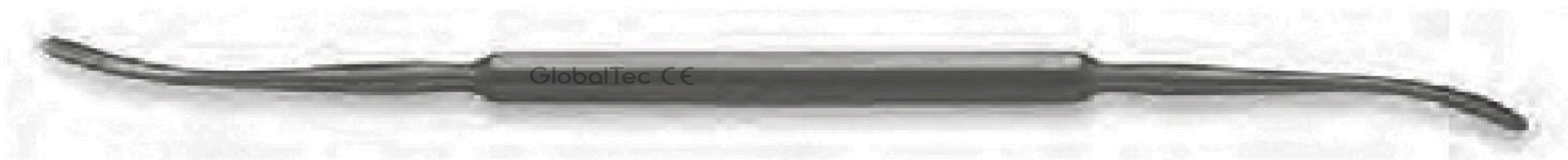

ORGT 9201-18

## MEASURING INSTRUMENTS

### Stainless Steel Measuring Ruler

Code	Length
ORGT 5005-15	15cm/6"
ORGT 5005-30	30cm/12"



### Measuring Caliper

- 25cm/10" Length
- Measuring Range 0-50mm

ORGT 7334-20

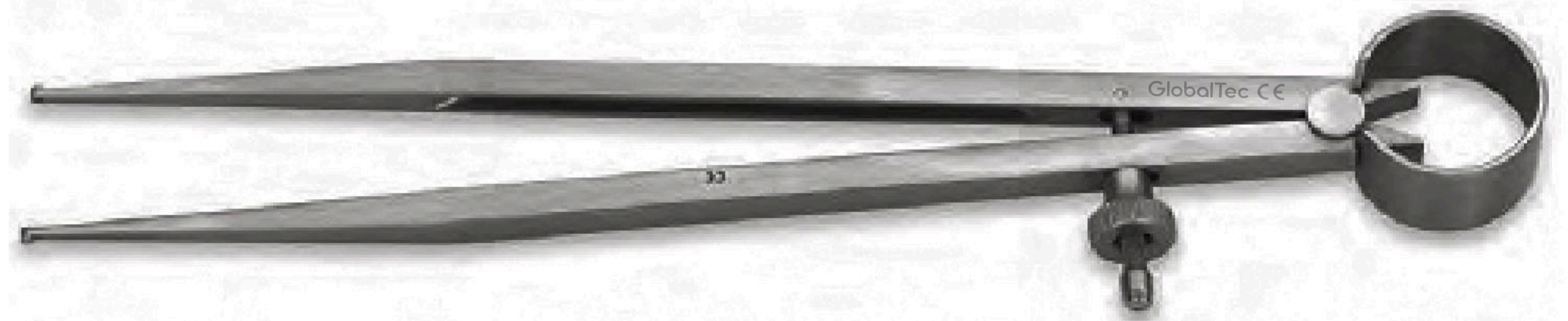

### Vernier Caliper

- 22.5cm/9" Length
- Measuring Range 15cm

ORGT 7338-00

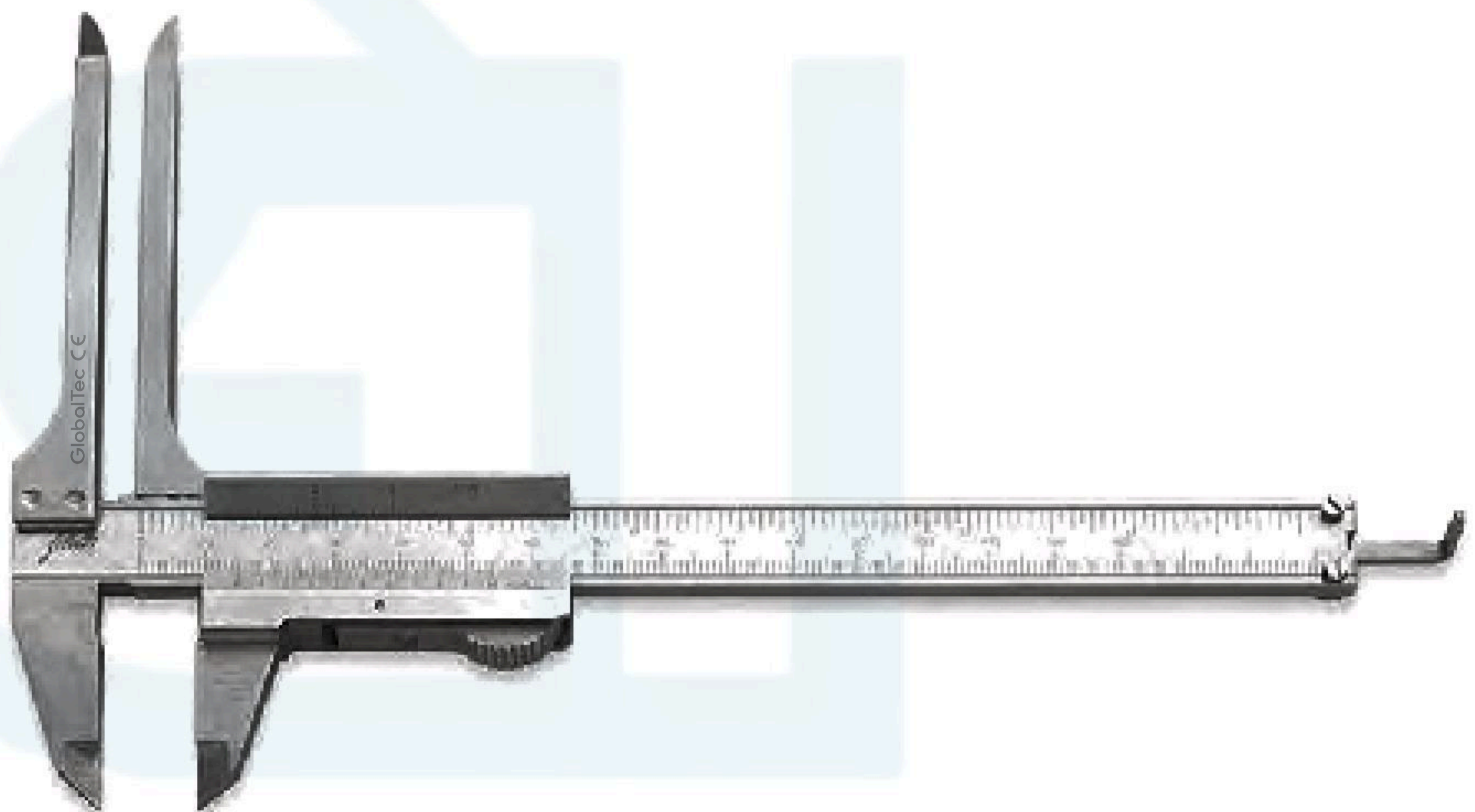

### Depth Gauge

- Measuring Depth upto 50mm

ORGT 7350-00

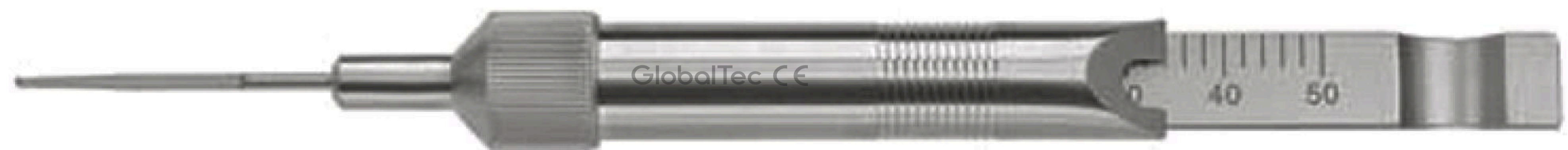

### Depth Gauge

- Measuring Depth upto 70mm

ORGT 7370-00



## BONE TUNNELLING & SUTURE PASSING

### Penetrating Bone Gouge

- 22cm/8¾" Length
- 3mm Wide Tip

ORGT 0804-22



### Percussion Bone Awl

- 22cm/8¾" Length
- Curved with Metal Handle

ORGT 0805-22



### Penetrating Bone Awl

- 18cm/7" Length
- Tufnol Handle

ORGT 0806-18



### Crohet Hook Suture Paser

- 18cm/7" Length
- Tufnol Handle

ORGT 0806-18

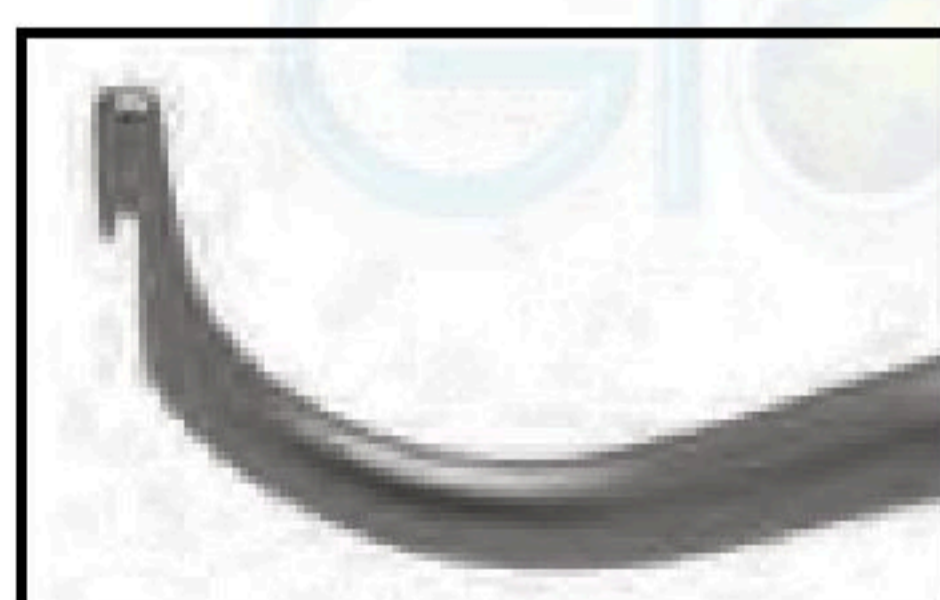

### Suture Passer

- 18cm/7" Length
- Tufnol Handle
- With Hole in Tip

ORGT 0806-18



The Bone Awls and Suture Passers are used to place sutures along the edge of the Glenoid Rim

## BONE PEFORATING FORCEPS & ELEVATORS

### Glenoid Perforating Forceps

- 27cm/6¾" Length

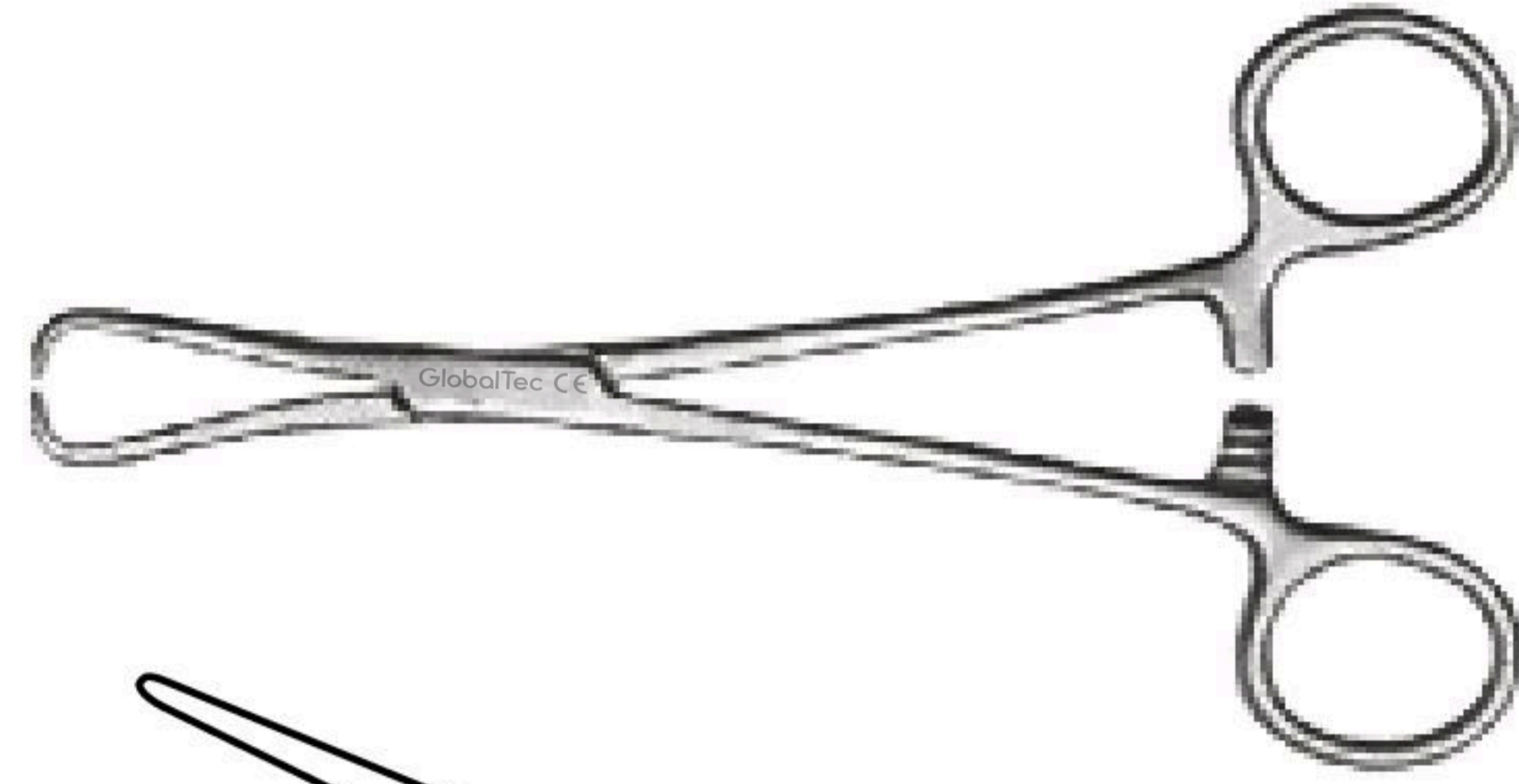

For Perforating holes in the Glenoid Rim

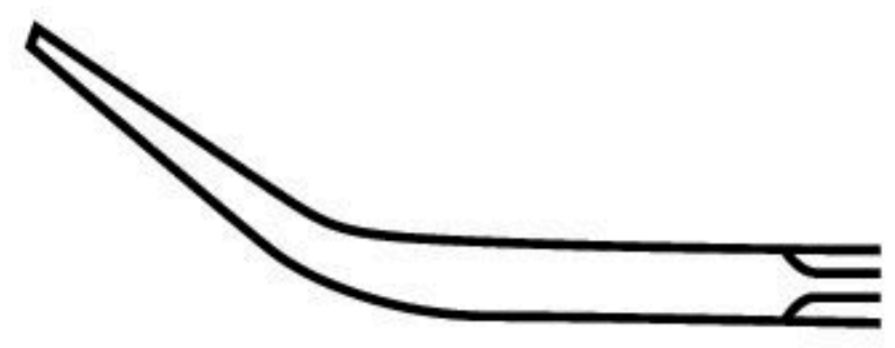

Strong Curved

ORGT1859-17



Light Curved

ORGT1858-17

### Kolbel Glenoid Elevator

- 30cm/12" Length
- 15mm Width
- Curved
- Double Prong



ORGT 0596-15

### Kolbel Glenoid Elevator

- 30cm/12" Length
- 20mm Width
- Curved
- Double Prong



ORGT 0598-20

### Posterior Glenoid Elevator

- Curved Tip to sit on Posterior Rim of Glenoid
- For Posterior Retraction of the Humeral Head



Width Tip

ORGT1859-17	8mm
ORGT1859-17	12mm
ORGT1859-17	20mm

## HUMERAL HEAD RETRACTORS

### Fukuda Humerus Head Retractor

- 22.5cm/9" Length

ORGT 0594 -32



ORGT 0594 -32

ORGT 0594 -35

ORGT 0594 -37

Width  
32mm  
35mm

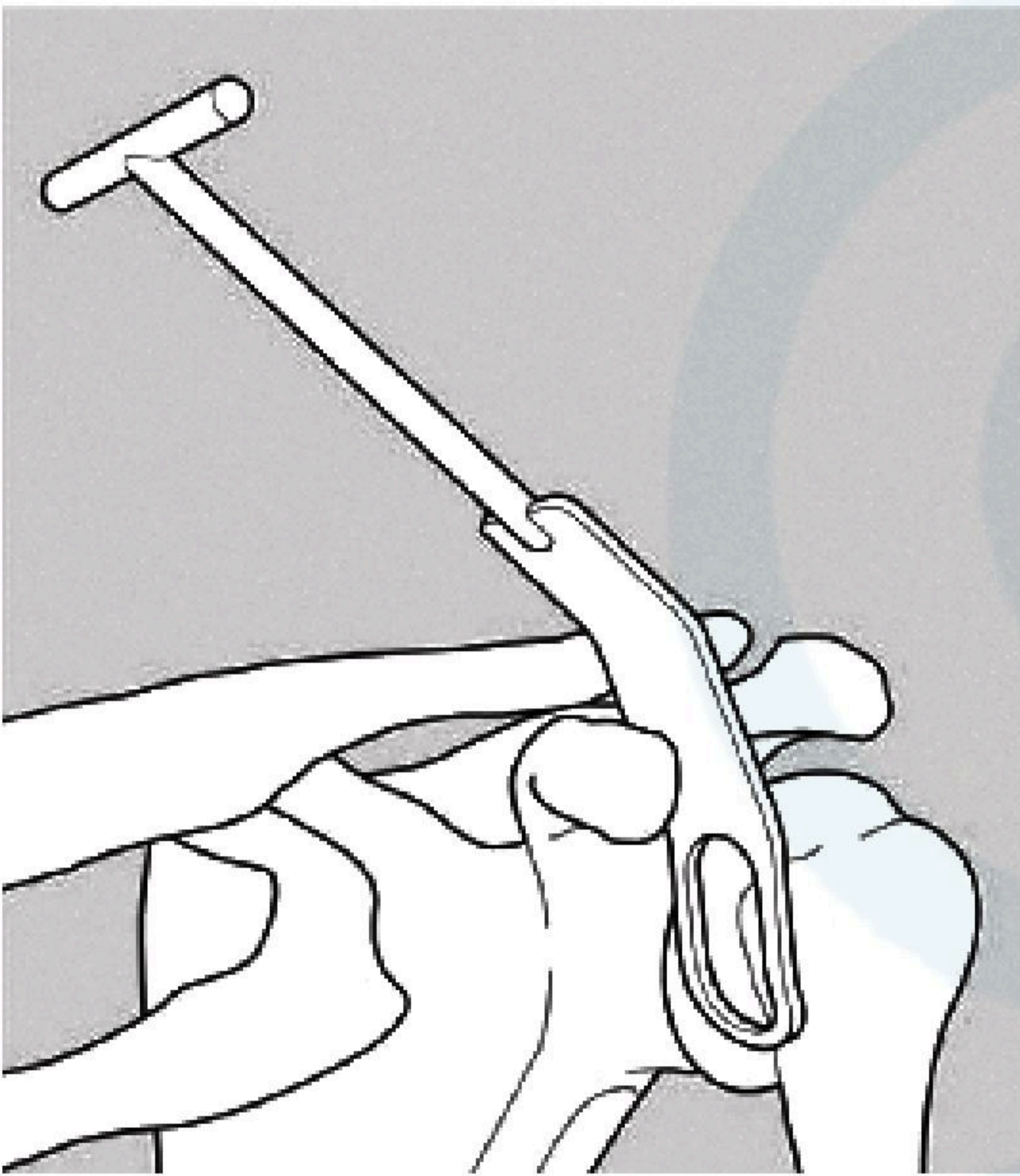

### Humerus Head Retractor

- 18cm/7" Length
- Strongly Curved
- Double Blunt Prongs

ORGT 0592 -18



**ELEVATORS**

**Battman Human head Retractor**

- 22.5cm/6¾"Length
- 30-mm width
- Double Prongs

ORGT 0590 -30



**Humerus Head Retractor**

- 25cm/8¾"Length

ORGT 0592 -21

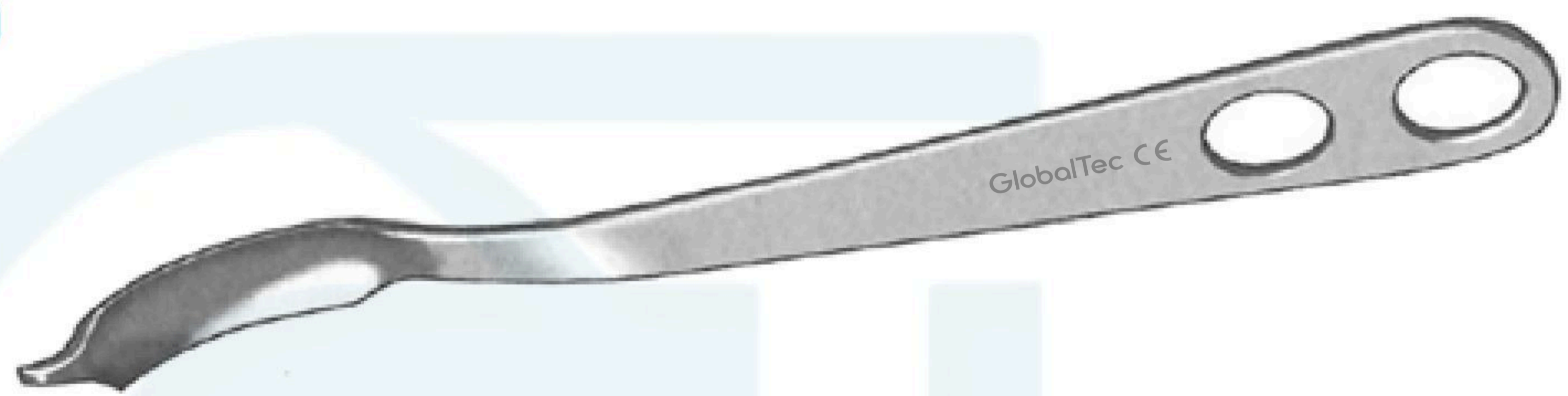

**Darrach Acromial Elevators**

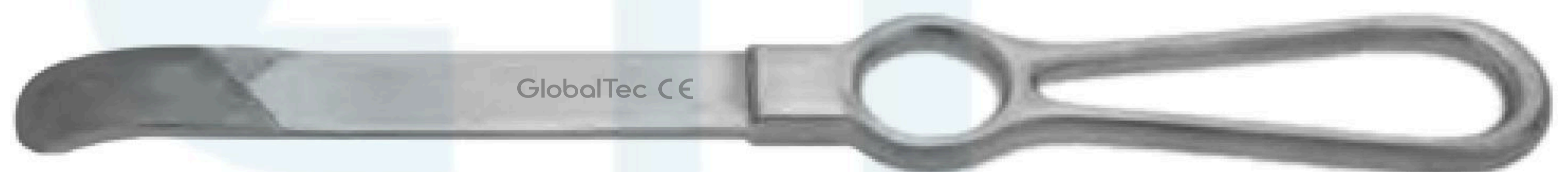

\*Illustrated

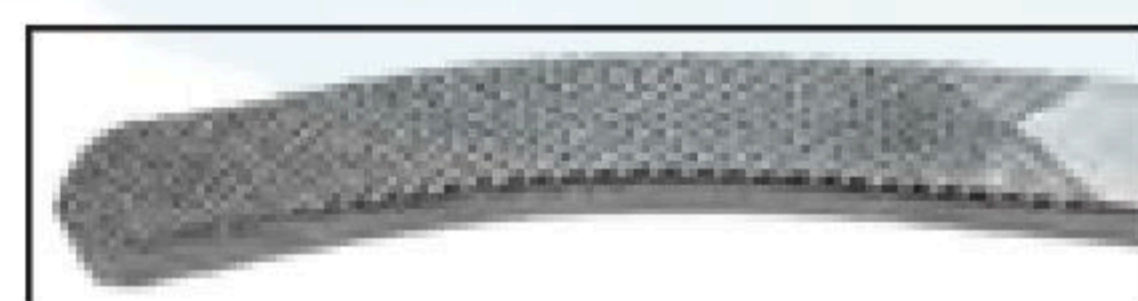
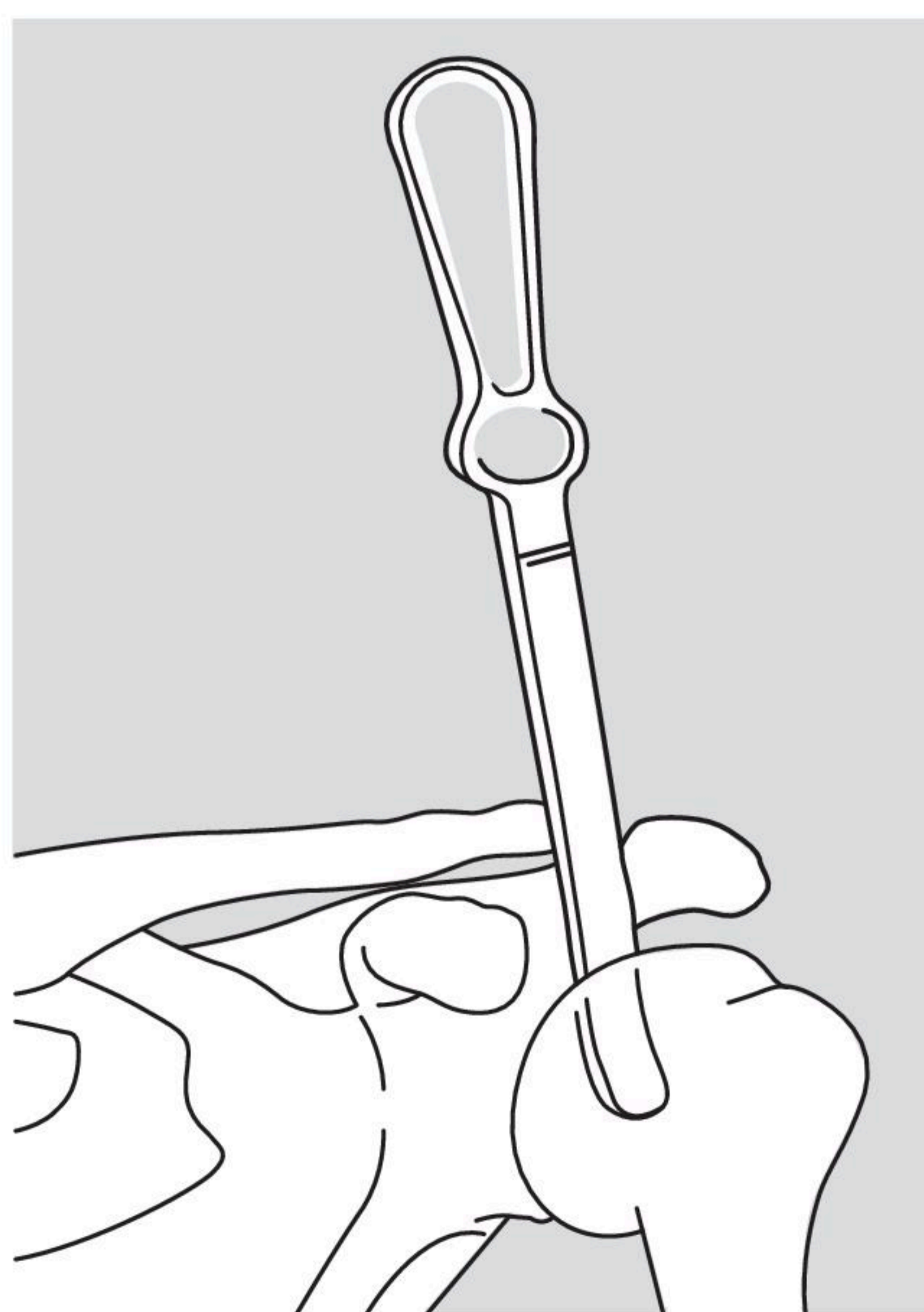

Small 9mm width, 26cm/10¼" length

ORGT 0599 -09

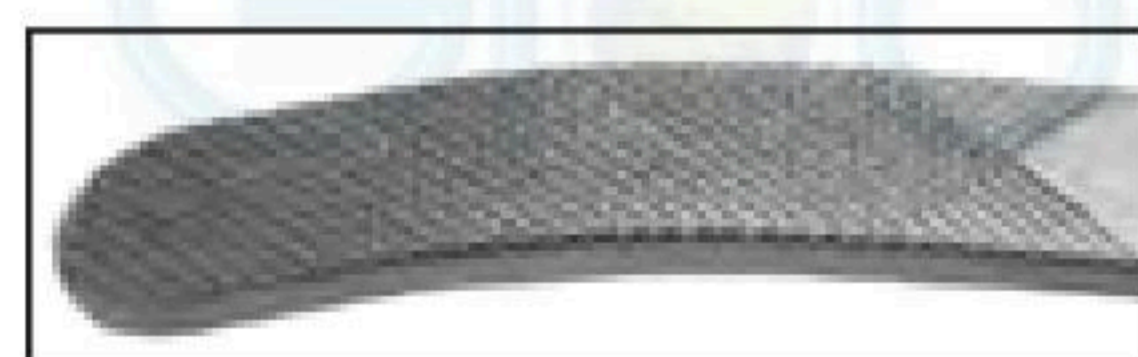

Medium 12mm width, 26cm/10¼" length

ORGT 0599 -12

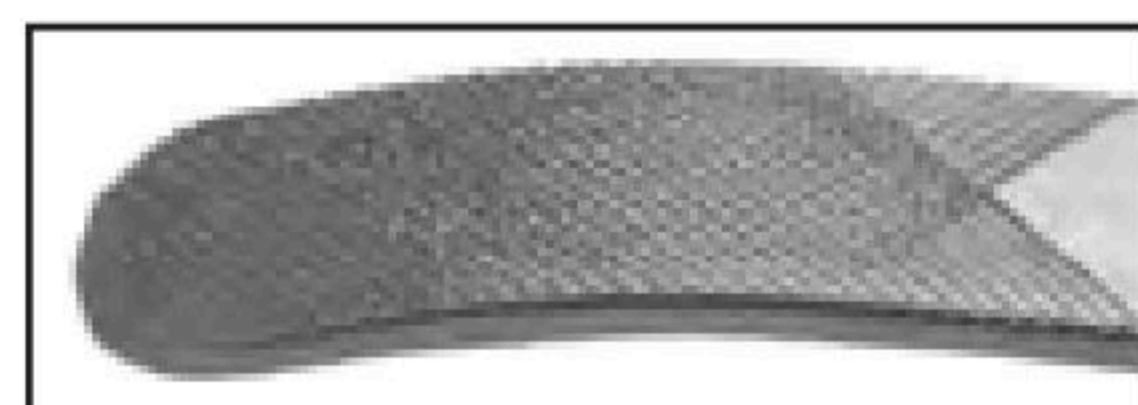

Large 16mm width, 26cm/10¼" length

ORGT 0599 -16

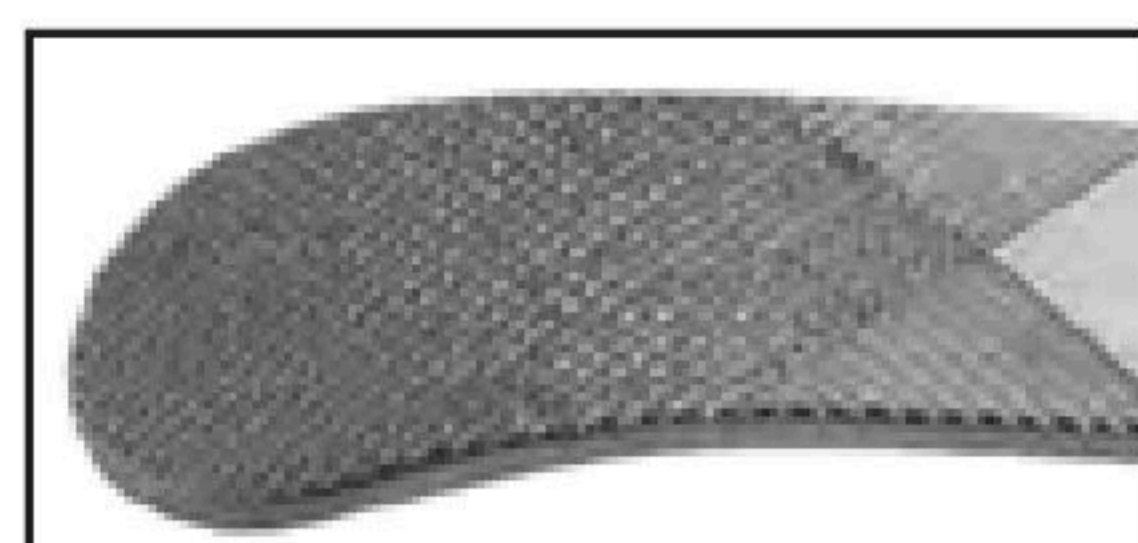

Extra Large 25mm width, 36cm/14¼" length

ORGT 0599 -25

Set of 4 Elevators

ORGT 0599 -00

## SOFT TISSUE & MUSCLE RETRACTORS

### Subscapularis Spreader

- 18cm/7" Length

ORGT 6442 - 18



### Kolbel soft Tissue Retractors

- 18cm/7" Length

ORGT 6444 - 18



### Hendren Self Retaining

- For tissue and back subcutaneous fat
- 16cm/6½" Length
- 22mm x 13mm blades

ORGT 1063 - 16

- 14cm/5½" Length
- 18mm x 13mm blades

ORGT 1063 - 14



### Kolbel Self Retaining Glenoid Retractor with Center Blade

- 20cm/8" Length

ORGT 1063 - 20

- Center Blade
- Depth 6.4cm/2.5"

ORGT 1063 - 21

- Blades Pair
- 36mm x 36mm

ORGT 1063 - 36

- Blades - Pair
- 36mm x 53mm

ORGT 1063 - 53



## SOFT TISSUE & MUSCLE RETRACTORS

### Subscapularis Spreader

- 18cm/7"Length

ORGT 6442 - 18



### Kolbel soft Tissue Retractors

- 18cm/7"Length

ORGT 6444 - 18



### Hendren Self Retaining

- For tissue and back subcutaneous fat
- 16cm/6½"Length
- 22mm x 13mm blades

ORGT 1063 - 16

- 14cm/5½"Length
- 18mm x 13mm blades

ORGT 1063 - 14



### Kolbel Self Retaining Glenoid Retractor with Center Blade

- 20cm/8"Length

ORGT 1063 - 20

- Center Blade
- Depth 6.4cm/2.5"

ORGT 1063 - 21

- Blades Pair
- 36mm x 36mm
- Blades - Pair
- 36mm x 53mm

ORGT 1063 - 36

ORGT 1063 - 53

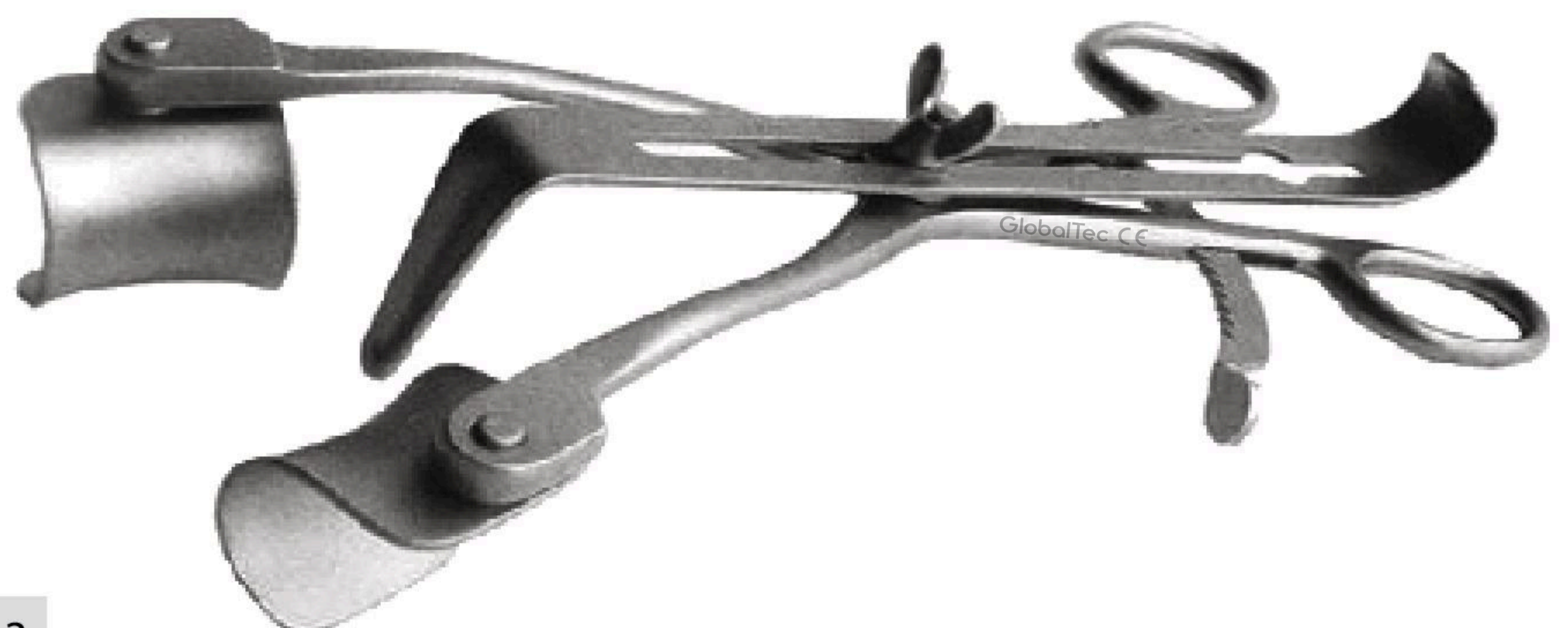

## SOFT TISSUE RETRACTOR

### Kolbel Shoulder Retractor

- With 3 Pairs of Detachable Blades
- 23cm/9" Length

ORGT 1062 -00



36mm

ORGT 1062 -36  
Small Blade



53mm

ORGT 1062 -53  
Medium Blade



68mm

ORGT 1062 -68  
Large Blade

### Browne Deltoid Retractor

- 27cm/10½" Length
- 260mm x 65mm Blade

ORGT 0500 - 27

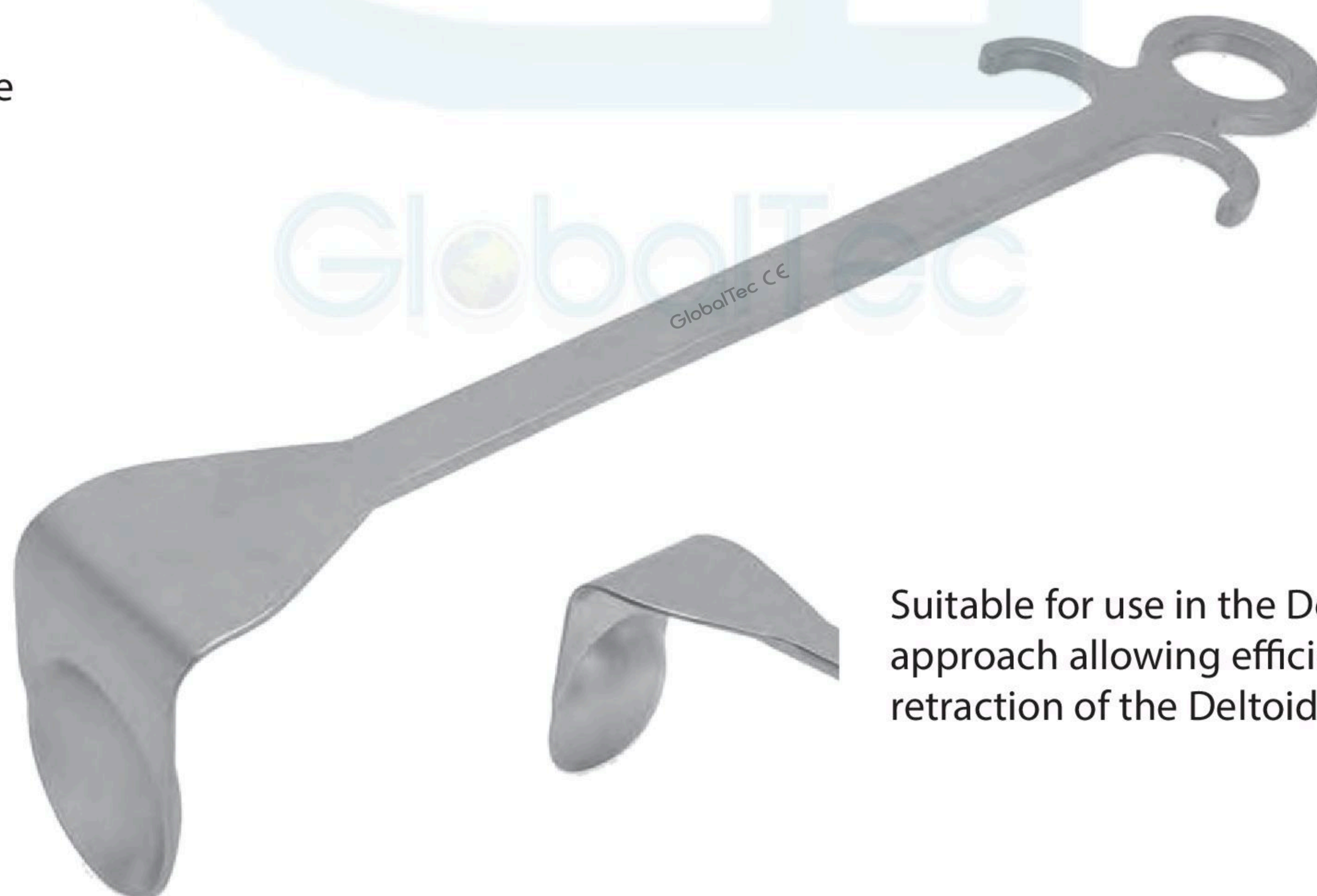

Suitable for use in the Delto-Pectoral approach allowing efficient retraction of the Deltoid

# SHOULDER RETRACTOR

## Titanium Bladed Shoulder Retractor

Complete set with:

- 1 x Frame
- 2 x Blade Holders
- 2 Sets of Titanium Blades
- Sterilizing Container

ORGT 1007 -00



## Frame with Articulating Joints

- Quick lock + unlock for Blades
- Maximum spread 10cm

ORGT 1088 - 00

## Blade Holder

ORGT1088 -00



## Titanium Retractor Blades

- 30 Angled
- Small Blade Size  
22mm x 55mm
- Large Blade size  
22mm x 55mm



MISCELLANEOUS

**Retractor Cuff Awl**

- 25cm/10" Length



ORGT 0805-24

**Arthroscopic Shoulder Rasp**

- 25cm/10" Length



ORGT 231-01

**Cement Removal Gouges**

- 22.9cm/9" Length

ORGT 6305 -23      Width  
5mm

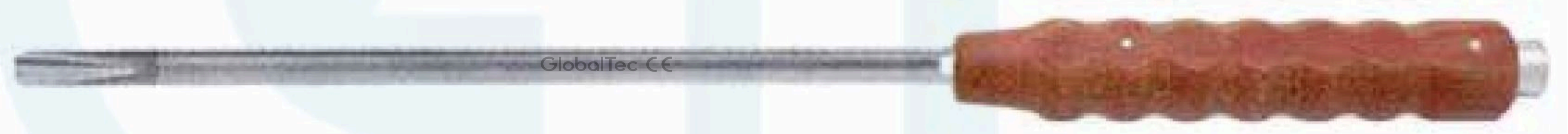

ORGT 6307 -23      Width  
7mm

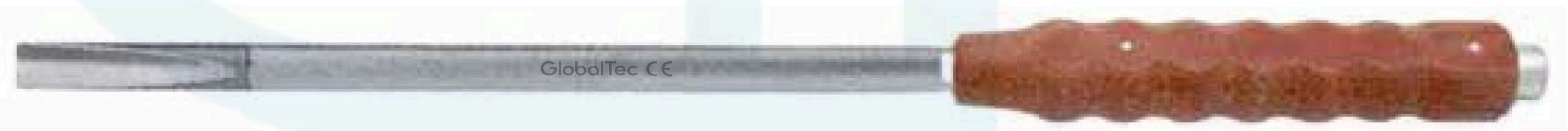

ORGT 6309 -23      Width  
9mm



ORGT 63011-23      Width  
11mm

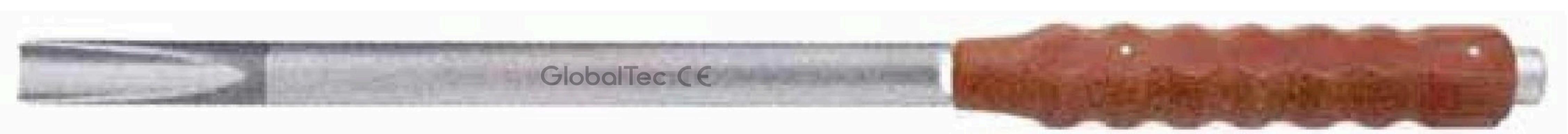

**Offset Retractor**

- 21.6cm x8.5"mm
- Leg Depth 7.5 cm/3"

ORGT 4818-44



# GREAT CREATIONS COMES FROM THE SINCERITY

## WHO WE ARE

GlobalTec Surgical Instruments is a trusted provider of high-quality specialty surgical instruments. With deep industry expertise, our specialists ensure precision, reliability, and 100% customer satisfaction.

We deliver unmatched value with a surgeon satisfaction guarantee, offering instruments tailored to your exact specifications. With 99% customer satisfaction, we ensure superior quality and performance in every product.

Our strength lies in our skilled professionals and commitment to excellence, providing only the best instruments that meet the highest industry standards.



## Our Other Products :

*Cardiac Surgery • Endoscopic Surgery • Gynecology Surgery • General Surgery  
Hand Surgery • Micro Surgery • Plastic Surgery  
Angioplasty Surgery • Spine Surgery*



**+91 7994555004**  
Office **+91 04802733660**  
sales@globaltecsurgical.com

DOOR No. 17/240, MELOOR P O, CHALAKUDY, THRISSUR, KERALA - 680 311

Email: info@globaltecsurgical.com, sales@globaltecsurgical.com, customercare@globaltecsurgical.com,

Website: www.globaltecsurgical.com. Phone: +91 0480 2733660 Mob: +91 7994555004



Surgicals Instruments



**ORTHOPAEDIC**  
**— INSTRUMENTS —**



DOOR No. 17/240, MELOOR P O, CHALAKUDY, THRISSUR, KERALA - 680 311

Email: [info@globaltecsurgical.com](mailto:info@globaltecsurgical.com), [sales@globaltecsurgical.com](mailto:sales@globaltecsurgical.com), [customercare@globaltecsurgical.com](mailto:customercare@globaltecsurgical.com),

Website: [www.globaltecsurgical.com](http://www.globaltecsurgical.com). Phone: +91 0480 2733660 Mob: +91 9349855004