



GlobalTec

Surgical Instruments

CDSCO Reg No : Globel-thris-KL/M/MD/019721



HAND & FOOT SURGERY

INSTRUMENTS



Introduction

GlobalTec Surgical is a highly experienced manufacturer of surgical instruments. With our wide range of products, we provide instruments for surgeries from head to toe.

We present our catalogue detailing our range of instruments specialising in orthopaedic surgery.

Our specialist instruments are manufactured to the highest possible standards using the most modern processes and technology. Based in Thrissur, the cultural capital of Kerala - "God's Own Country" - we leverage technological advancements to deliver world-class surgical solutions.



The
EXCELLENCE
Along EXPERIENCE



+91 7994555004
Office +91 04802733660
sales@globaltecsurgicals.com

DOOR No. 17/240, MELOOR P O, CHALAKUDY, THRISSUR, KERALA - 680 311

Email: info@globaltecsurgicals.com, sales@globaltecsurgicals.com, customercare@globaltecsurgicals.com,

Website: www.globaltecsurgicals.com. Phone: +91 0480 2733660 Mob: +91 7994555004

INDEX

SOFT TISSUE INSTRUMENTS

	Page No.
Easy-Cut Scissors	1 & 4
Dissecting Forceps	5 & 6
Needle Holders	7 & 8
Skin Hooks	9
Hand Held Retractors	10
Self Retaining Retractors	11
Tuppers Hand Retractor	12
Artery Forceps	13
Scalpel Handles & Marking Pens	14

BONE INSTRUMENTS

Bone Nibblers	15 & 16
Bone Cutters	17
Mallets	18
Osteotomes & Gouges	19 & 20
Bone Elevators	21 & 22
Bone Curettes	23
Dissectors	24
Bone Holding Forceps	25
Bone Spreaders & Camps	26
Wiring Cutters, Pullers & Pliers	27 & 28

TENDON INSTRUMENTS

Tendon Interlacing Forceps & Retrievers	29 & 30
Tendon Strippers	31
Meyer Tendon Trimming Set	32
Hand Surgery Instrument Set	33 & 34

SMALL JOINT ARTHROSCOPY
INSTRUMENTS

Arthroscopic Punch Forceps	35
Arthroscopic Hooks	36
Arthroscopic Telescopes	37 & 38

MICRO INSTRUMENTS

	Page No.
Micro Vessel Dilators	39 & 40
Micro Forceps	41 & 42
Micro Scissors	43 & 44
Micro Needle Holders	45
Acland Micro Vessel Clamps	46 & 47
Recommended Micro Instrument Sets	48
Instrument Containers	49
Sterile Packed Kirschner Wires	50
Digiband Sterile Digital Tourniquet	51

HAND & FOOT SURGERY

SCISSORS

Iris Scissors

11.5cm/4 1/2" Straight
Micro Serrated Cutting Edge

HFGT 7612 -11

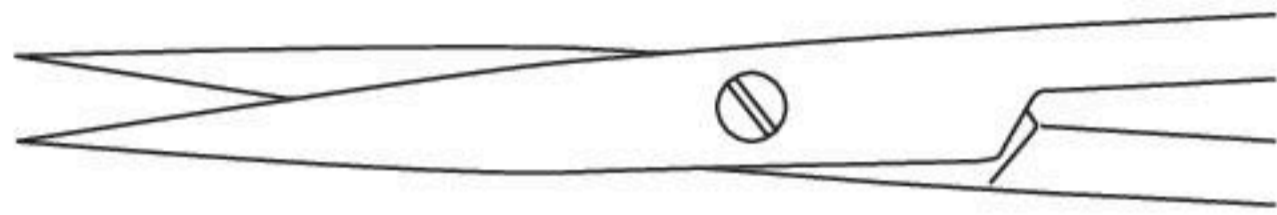

Iris Scissors

11.5cm/4 1/2" Curved
Micro Serrated Cutting Edge

HFGT 7613 -11



Strabismus Scissors

11.5cm/4 1/2" Straight
Micro Serrated Cutting Edge

HFGT 7622 -11



Strabismus Scissors

11.5cm/4 1/2" Curved
Micro Serrated Cutting Edge

HFGT 7623 -11



HAND & FOOT SURGERY
SCISSORS
Stevens Tenotomy Scissors

- 11.5cm/4 1/2" Straight
- Micro Serrated Cutting Edge

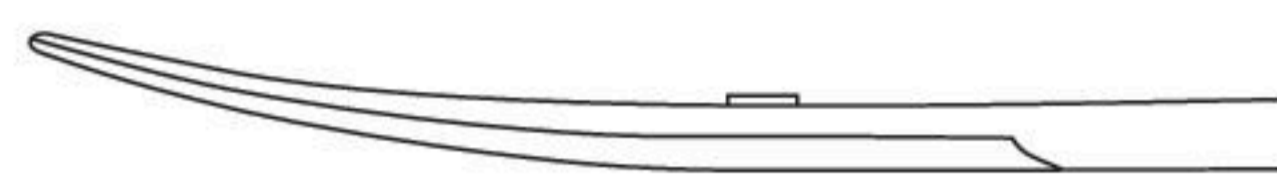
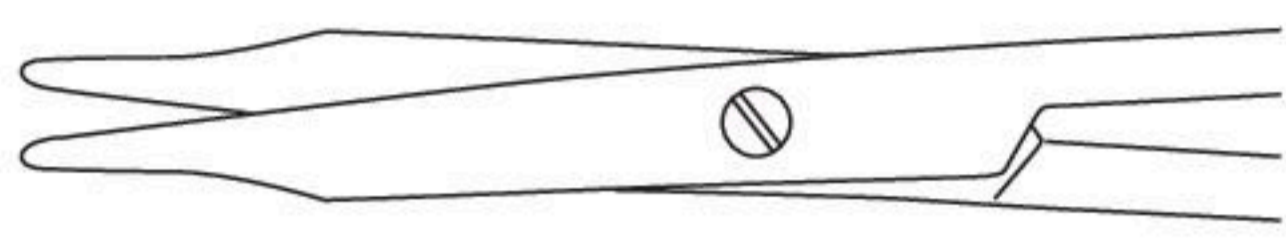
HFGT 7633 -11

Stevens-Stille Pattern Tenotomy Scissors

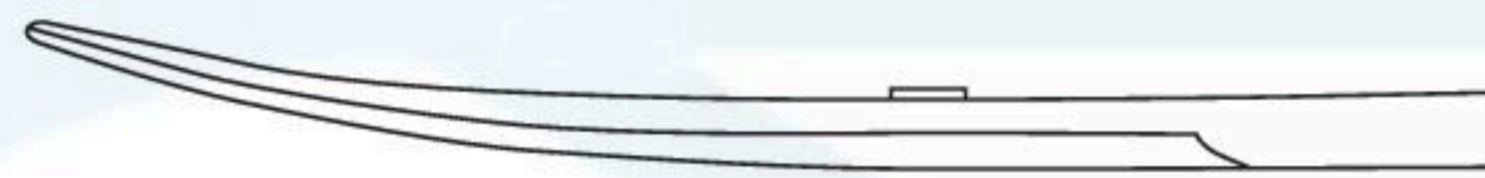
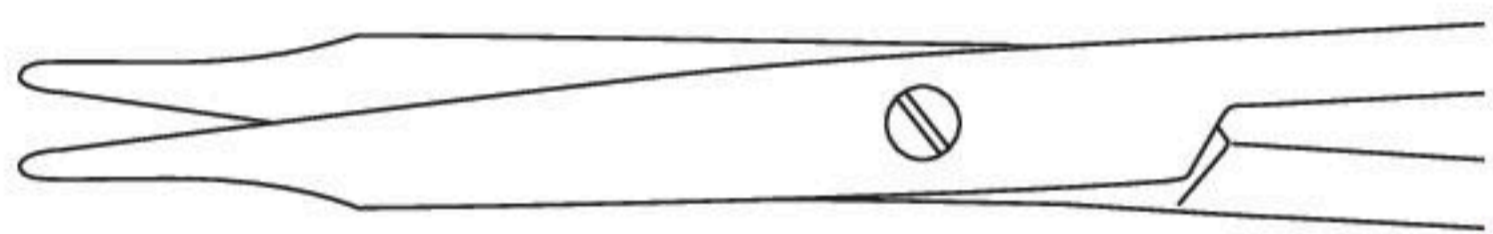
- 11.5cm/4 1/2" Curved
- Micro Serrated Cutting Edge

HFGT 7633 -12

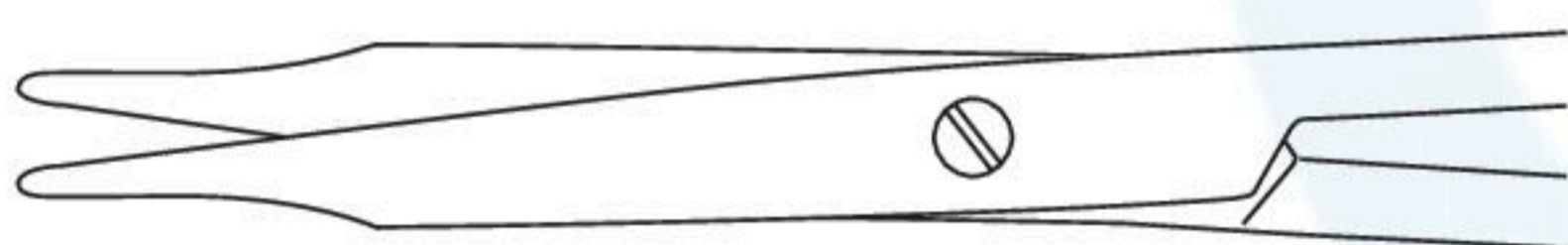
Jameson-Werber Scissors

- 11.5cm/4 1/2" Straight
- Micro Serrated Cutting Edge

HFGT 7643 -13

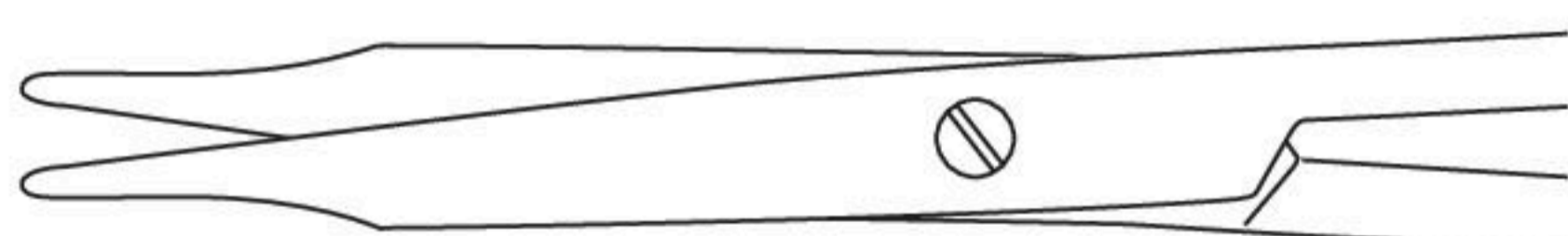
Jameson Scissors

- 11.5cm/4 1/2" Curved
- Micro Serrated Cutting Edge

HFGT 7643 -15

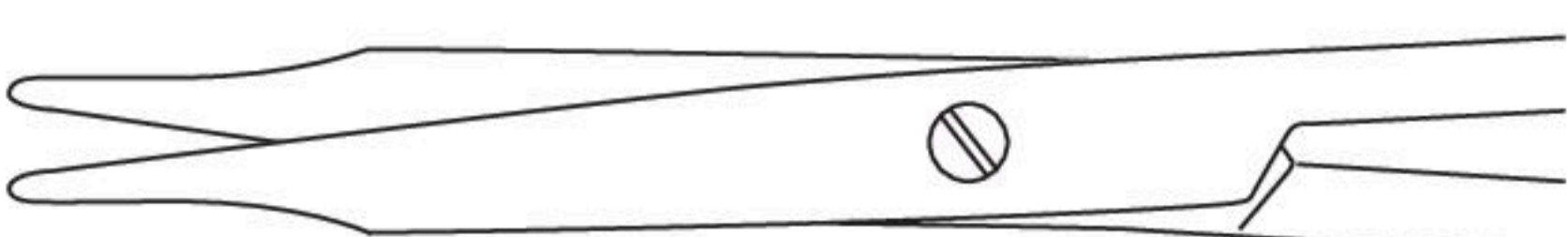
Jameson Scissors

- Strong pattern
- Micro serrated cutting edge

HFGT 7645 -15

SCISSORS

Slim Baby Metzenbaum Easy-Cut Scissors

- 14cm/5 ½" Curved
- Micro Serrated Cutting Edge

HFGT 7661 -14

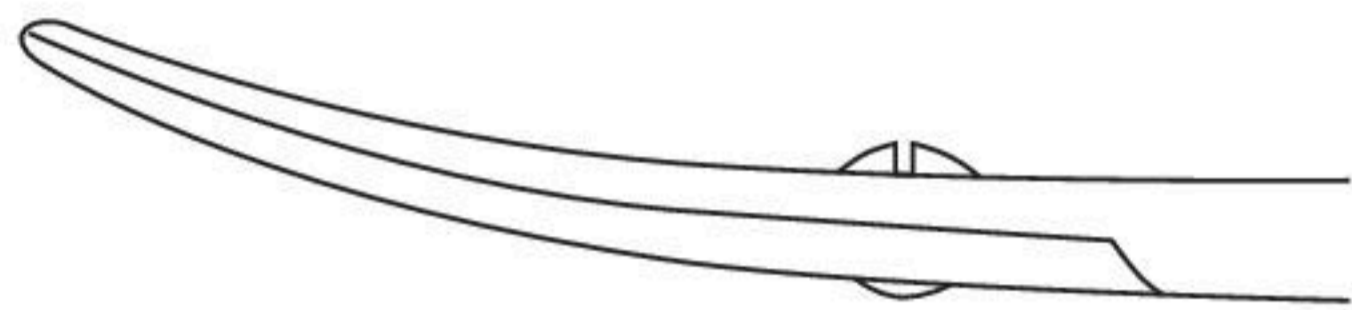

Slim Metzenbaum Easy-Cut Scissors

- 18cm/7" Curved
- Micro Serrated Cutting Edge

HFGT 7661 -18

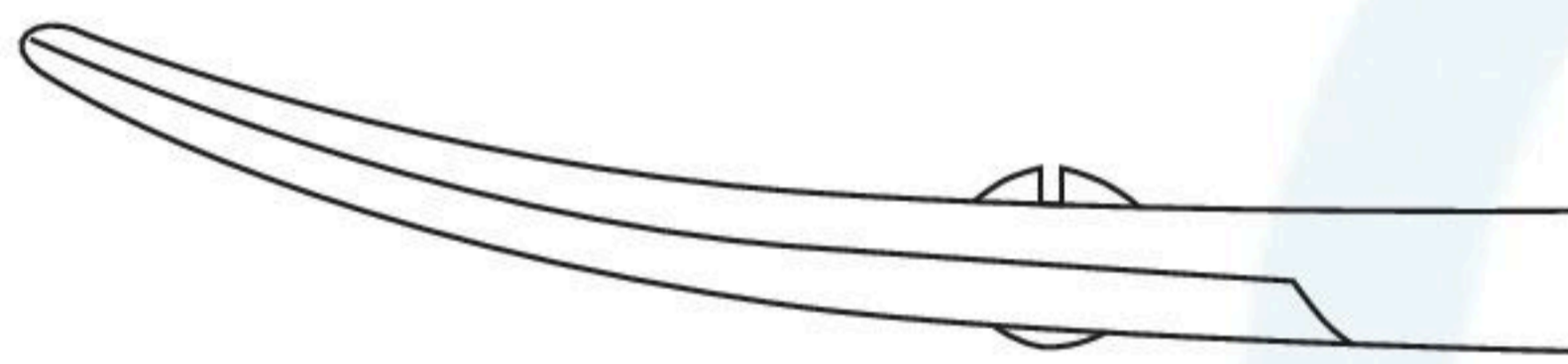

Baby Metzenbaum Easy-Cut Scissors

- 14cm/5 ½" Curved
- Micro Serrated Cutting Edge

HFGT 7663 -14

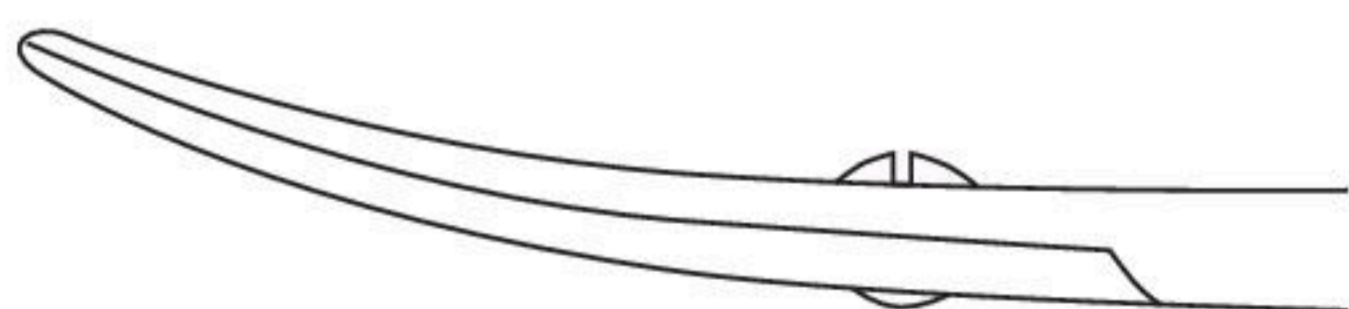

McIndoe / Metzenbaum Easy-Cut Scissors

- 18cm/7" Curved
- Micro Serrated Cutting Edge

HFGT 7663 -18

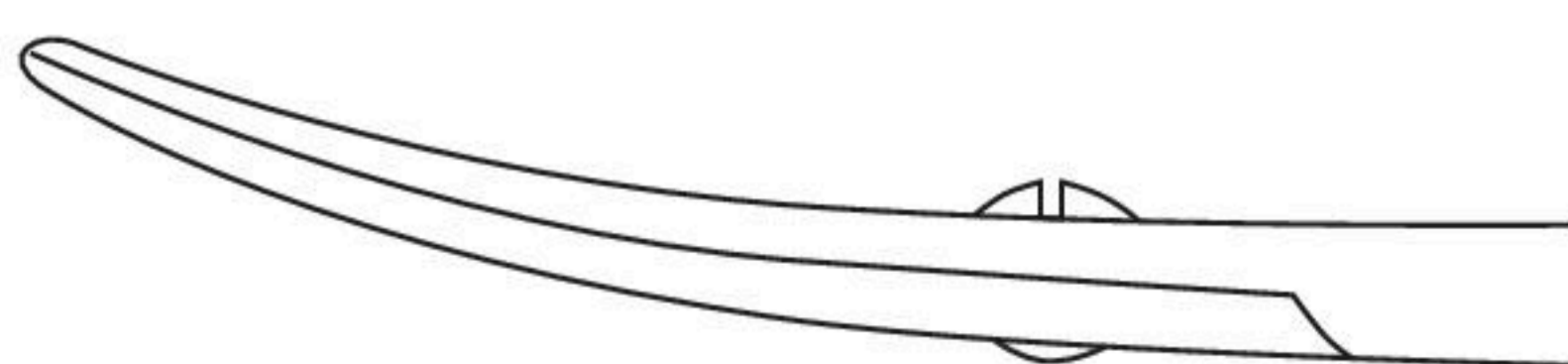

HAND & FOOT SURGERY
SCISSORS
Mayo Easy-Cut Scissors

- 14cm/5 ½" Curved
- Micro Serrated Cutting Edge

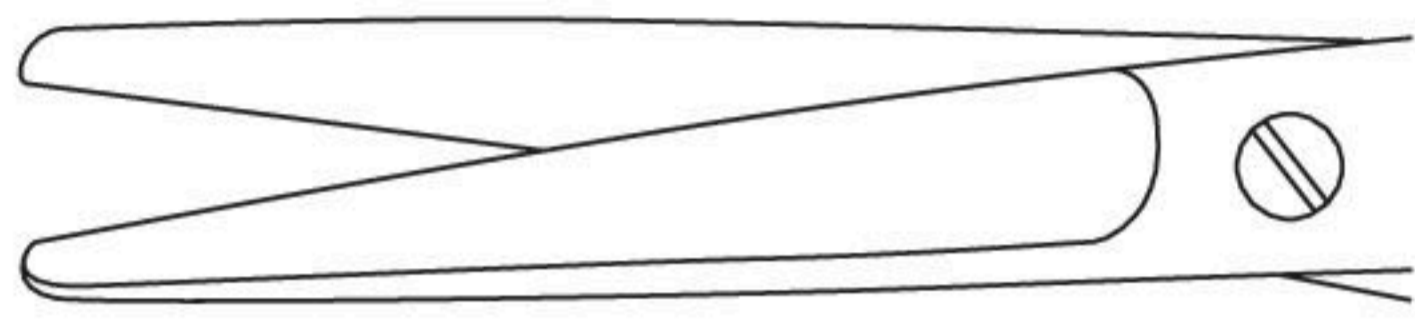
HFGT 7652 -14

Mayo Easy-Cut Scissors

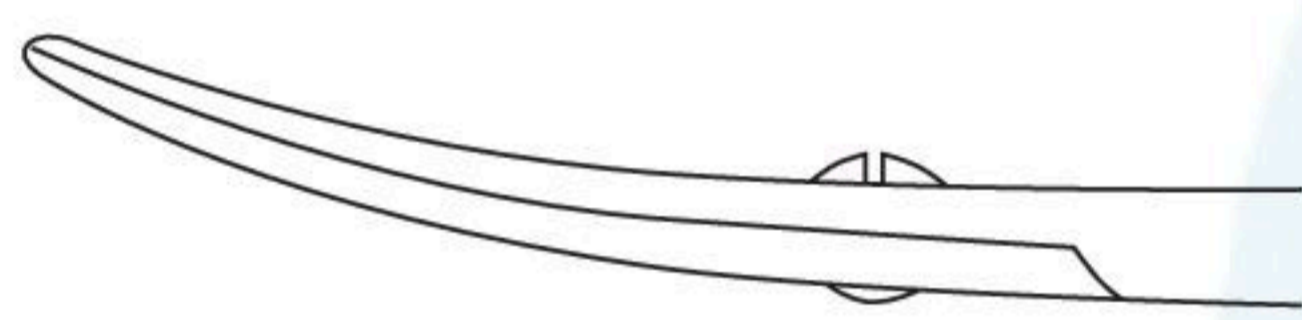
- 14cm/5 ½" Curved
- Micro Serrated Cutting Edge

HFGT 7653 -14

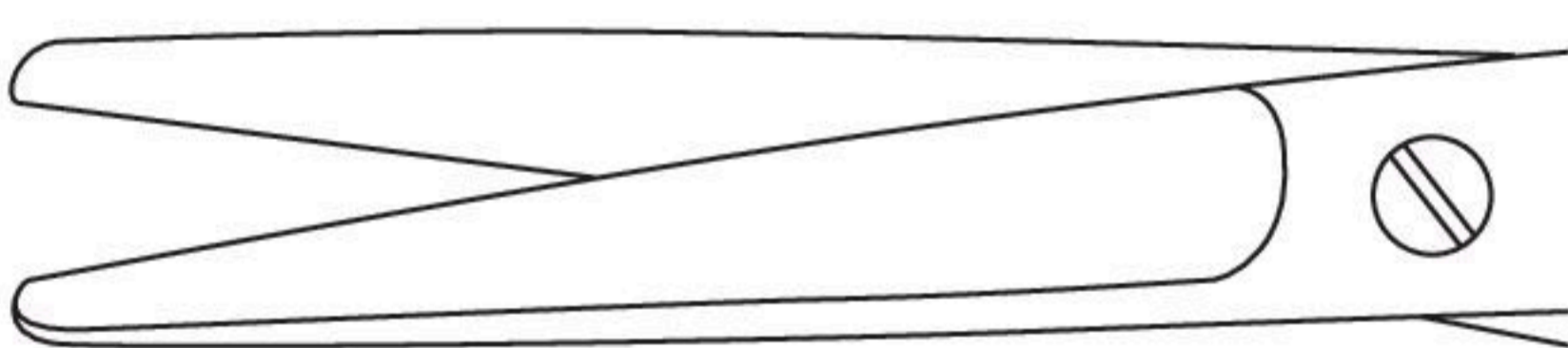
Mayo Easy-Cut Scissors

- 17cm/6 ¾" Curved
- Micro Serrated Cutting Edge

HFGT 7652 -17

Mayo Easy-Cut Scissors

- 17cm/6 ¾" Curved
- Micro Serrated Cutting Edge

HFGT 7653 -17

HAND & FOOT SURGERY
DISSECTING FORCEPS
Gillies Dissecting Forceps

- Toothed
- 15cm/6"

HFGT 5160-15

McIndoes Dissecting Forceps

- Non toothed
- 15cm/6"

HFGT 5170-15

Debakey-Diethrich Tissue Forceps

- 1.5mm tips
- 15cm/6"

HFGT 2015 -15

Debakey Tissue Forceps

- 2mm tips
- 15cm/6"

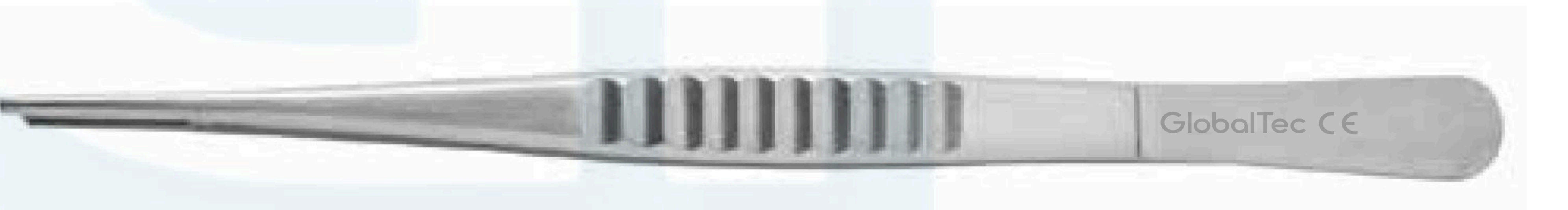
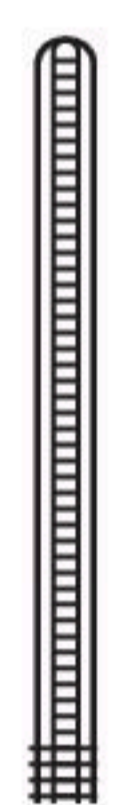
HFGT 2120 -15

Bipolar Forceps

- 1mm tips
- 11cm/4½"

70-02-41

Bipolar Forceps

- 1mm tips
- 16cm/6¼" length

70-01-51

HAND & FOOT SURGERY
DISSECTING FORCEPS
Adson Forceps

- Non Toothed
- 12cm/4¾"

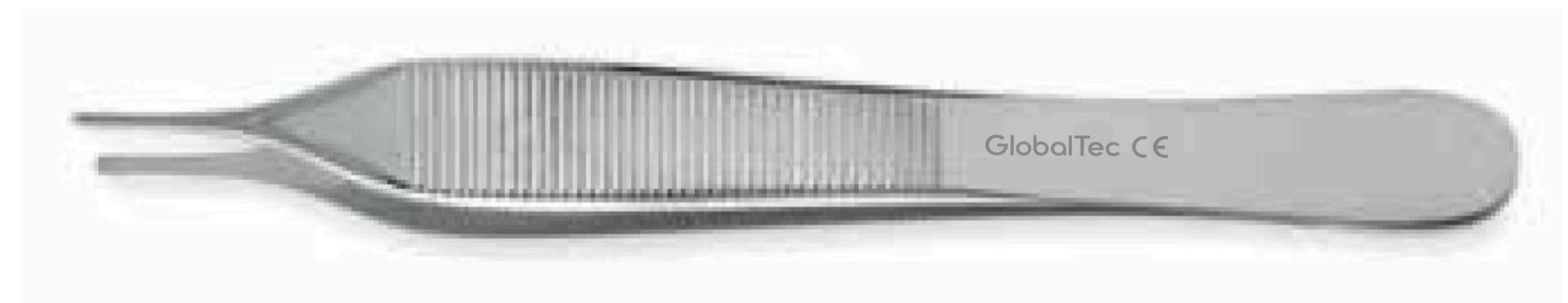
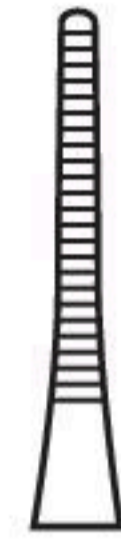
HFGT 5025-12

Adson Forceps

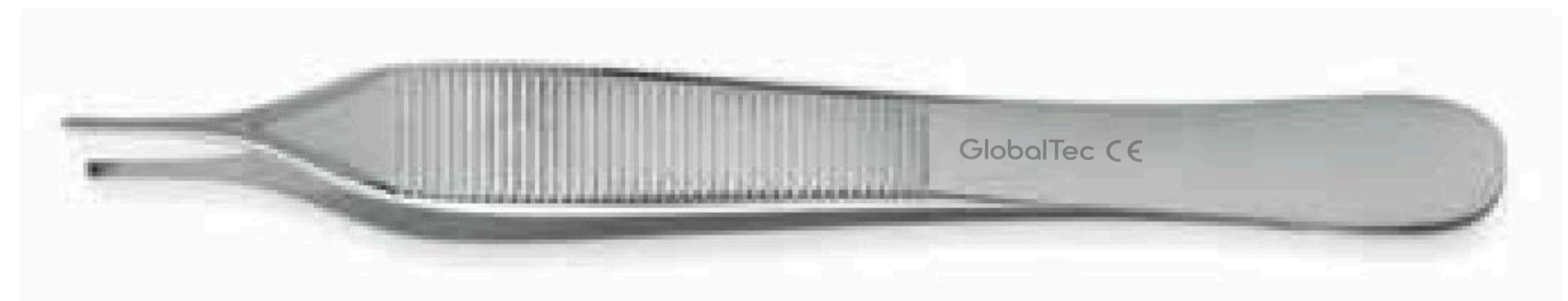
- Toothed
- 12cm/4¾"

HFGT 5120-12

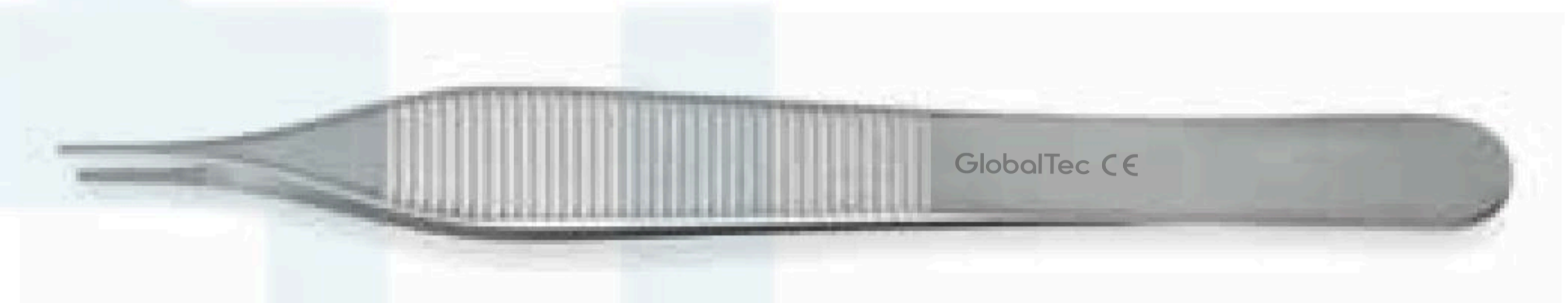
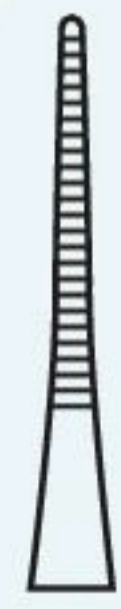
Micro Adsons Forceps

- Non Toothed
- 12cm/4¾"

HFGT 5035-12

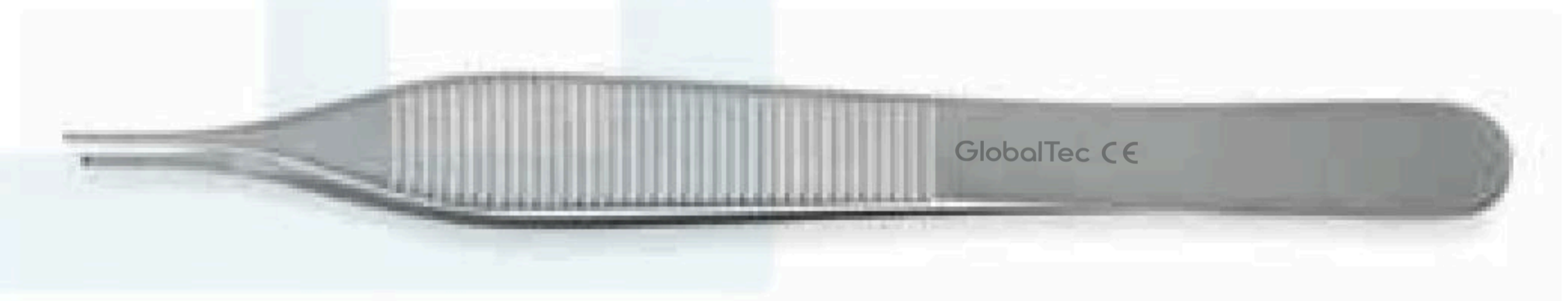
Micro Adsons Forceps

- Toothed
- 12cm/4¾"

HFGT 5130-12

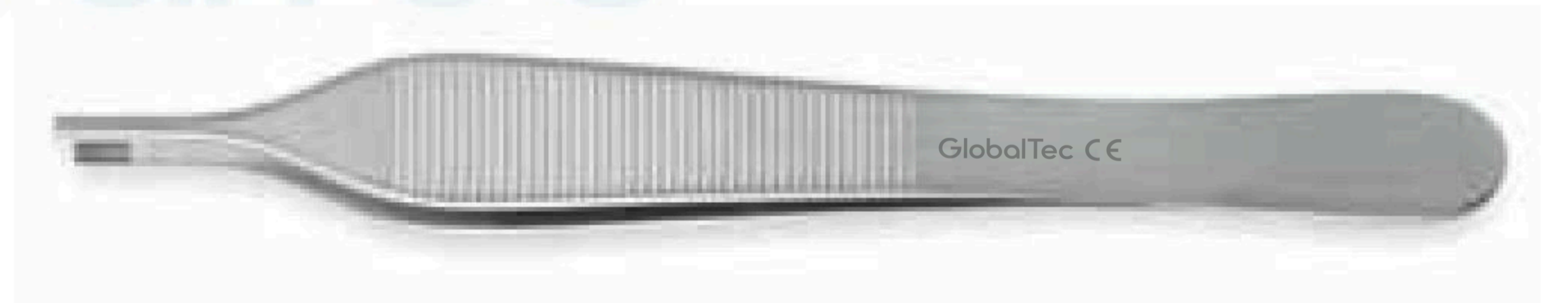
Adson Brown Forceps

- 7x7 teeth
- 12cm/4¾"

HFGT 5140-12

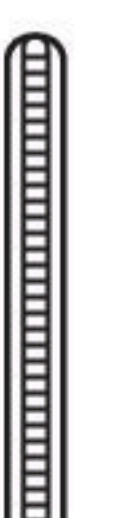
Adson-DeBakey Forceps

- 2mm teeth
- 12cm/4¾"

HFGT 5180-12

HAND & FOOT SURGERY

NEEDLE HOLDERS

Micron Fine Needle Holder

- 12.5cm/5"
- Diamond dusted jaws



HFGT 1018-12



Derf Needle Holder

- 12cm/4³/₄"
- Tungsten Carbide jaws



HFGT 703DE12

Smooth



HFGT 705DE12



Halsey Needle Holder

- 13cm/5"
- Tungsten Carbide jaws

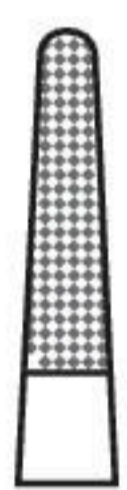

HFGT 706.DE12

Smooth



HFGT 704.DE12



Crile Wood Needle Holder

- Tungsten Carbide jaws



HFGT 712.DE15

15cm/6"



HFGT 734.DE18

18cm/7"



HFGT 734.DE20

20cm/8"

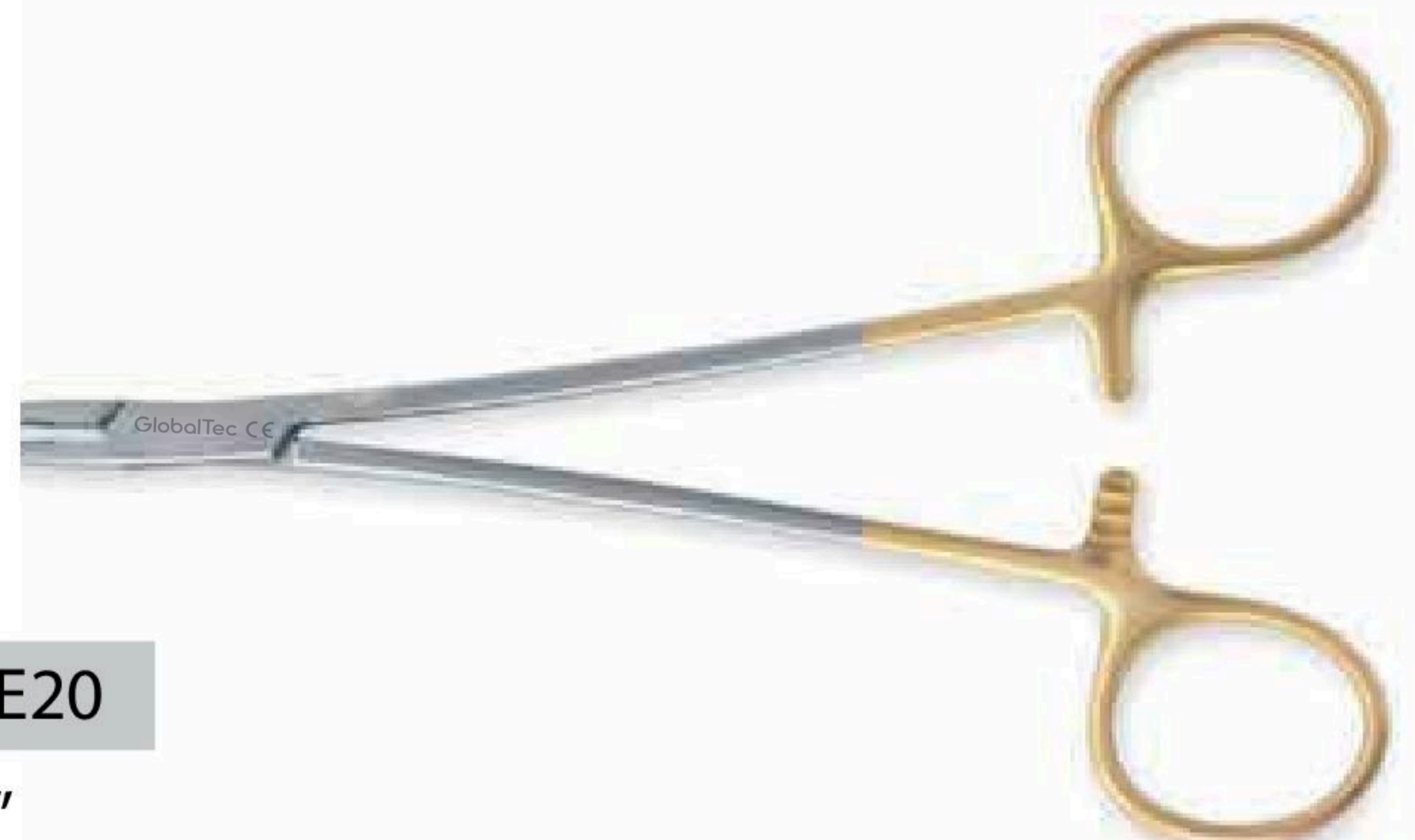

NEEDLE HOLDERS

Nieverts Needle Holder (offset ring)

- 13cm/5¼"
- Tungsten Carbide jaws



HFGT 83.DE13



Foster Gillies Combined Needle Holder/Scissors

- 13cm/5"
- Tungsten Carbide jaws



HFGT 775.SE-13



Gillies Combined Needle Holder/Scissors

- 13cm/5"
- Tungsten Carbide jaws



HFGT 775.DE-16



HAND & FOOT SURGERY
SKIN HOOKS
Kilner Detachable Skin Hook

- 15cm/6"

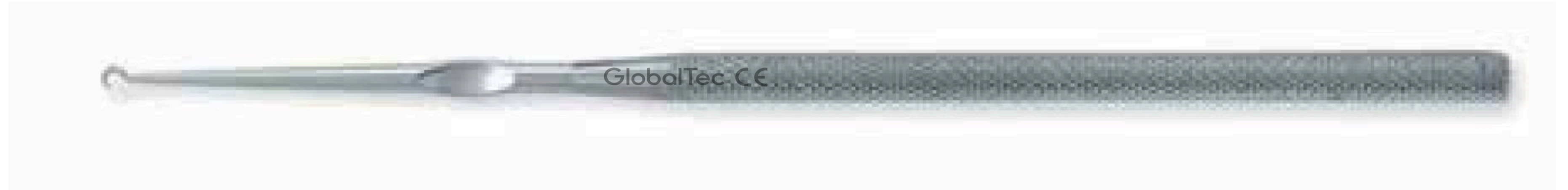
HFAS 5075 - 01

Gillies Skin Hook

- 18cm/7"

HFAS 5065 - 01 Small size

HF-AS-5065 - 02 large size

Klienert-Kutz Skin Hook

- 16cm/6¼"

HFAS 5055 - 01

Joseph Double Skin Hook

- 16cm/6¼"

HFAS 5402 - 10

Blunt Nerve Hook

- 16cm/6¼"

HFAS 5251 - 01

Blunt Crile Nerve Hook

- 14cm/6¾"

HFAS 5200 - 14

Cushing Blunt Hook

- 19cm/7½"
- 3mm tip

HFAS 9101 - 19

HAND & FOOT SURGERY

HAND HELD RETRACTORS

Catspaw Retractors

- 16cm/6¼"
- Semi-sharp prongs

HFGT 5252 - 03



Senn-Miller Retractor

- 16cm/6¼"
- Double ended

HFGT 5289-01 Sharp prong

HFGT 5289-02 Blunt prong



Kilner-Miniature Pattern Catspaw Retractor

- 15cm/6"
- Double ended

HFGT 5286-01



Ragnell-Davies Retractor

- 14cm/5½"
- Double ended

HFGT 5287-14



Desmarres Saddle Retractor

- 16cm/6¼"
- 12mm width

HFGT 5235-12

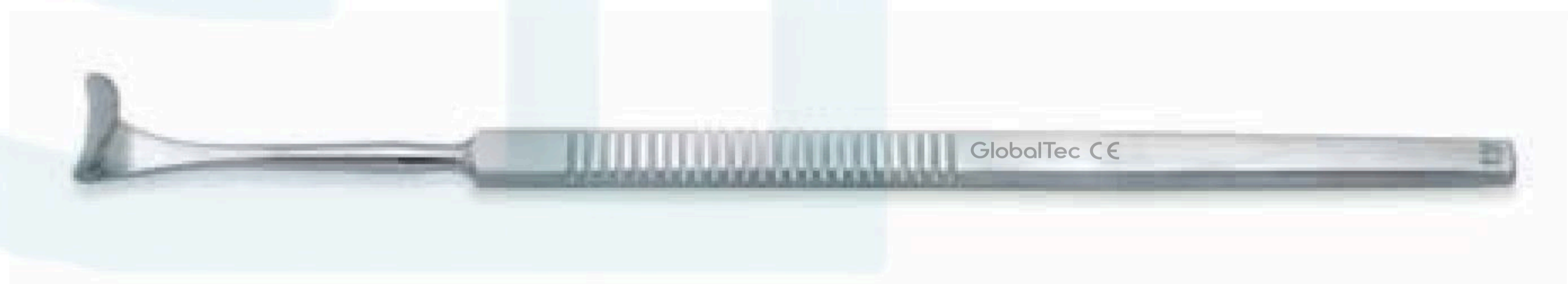

Mini-Langenbeck Retractor

- 16cm/6¼"

HFGT 5235-12 10 x 6mm*

HFGT 5235-12 17 x 5mm



Langenbeck Retractor

- 21.5cm/8½"

Small

Blade Size: 22mm x 6mm

HFGT 7653 -17

Medium

Blade Size: 45mm x 13mm

HFGT 7653 -17

Large

Blade Size: 65mm x 25mm

HFGT 7653 -17



SELF RETAINING RETRACTORS

Alms Retractor

- 4 x 4 teeth blun
- 7cm/2¾"
- 4mm depth prongs

HFGT 5200 - 70



Baby Weitlaner S/R Retractor

- 2 x 3 blunt prongs
- 11.5cm/4½"

HFGT 5701 - 10



West's S/R Retractor

- 3 x 4 sharp prongs
- 14cm/5½"

HFGT 4003 - 14

Weitlaner S/R Retractor

- 3 x 4 Blunt prongs
- 14cm/5½"

HFGT 4002 - 14



Finsen Small Wound Retractor

- 3 x 4 Teeth Blunt
- 7cm/2¾"

HFGT 5705-10



Kaupp Wound Retractor

- 4 x 4 Teeth Blunt
- 10cm/4"

HFGT 5710-14



HAND RETRACTOR

Tuppers Hand Retractor Set
Complete Set with container

HFGT 100/110

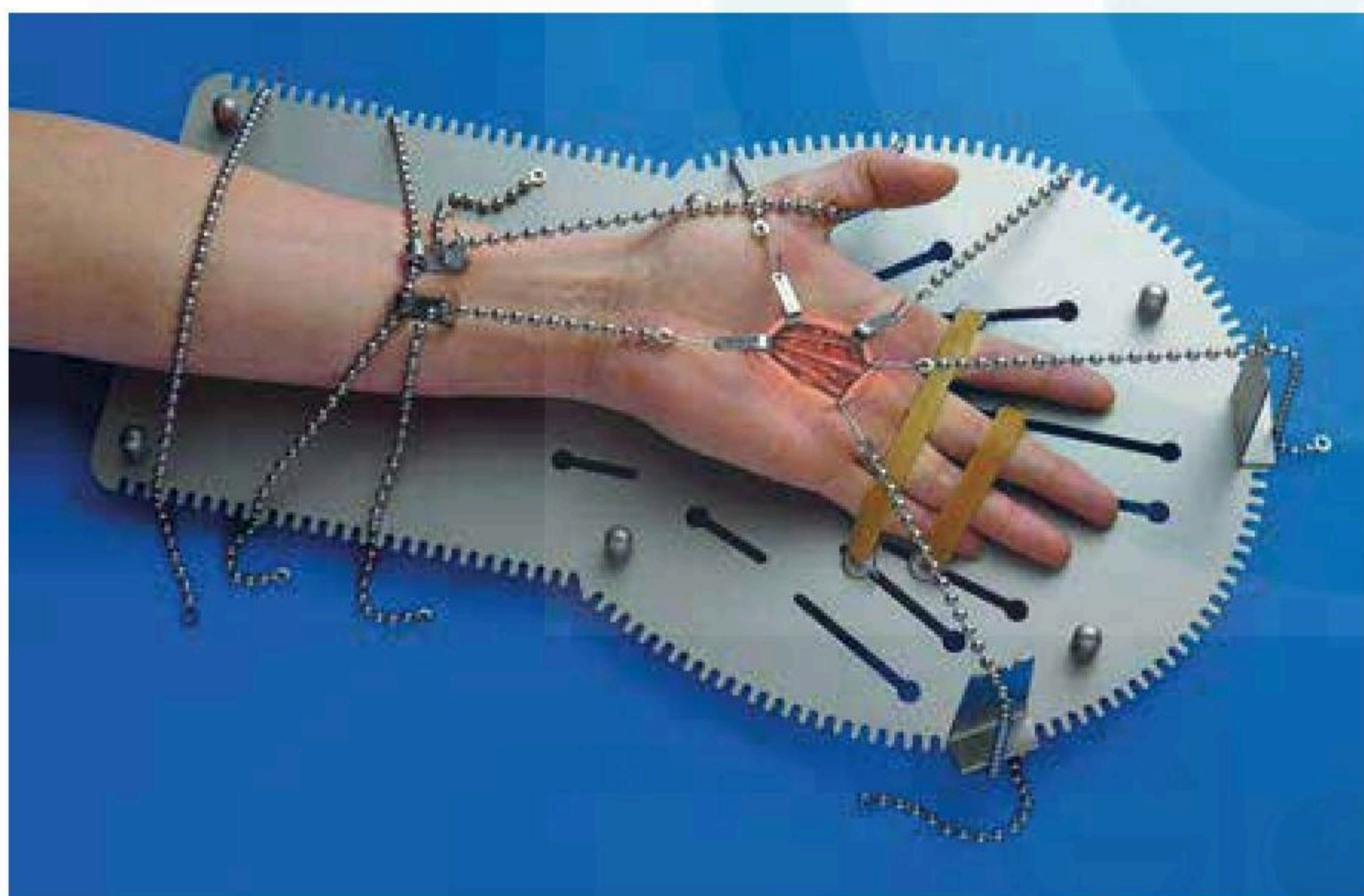
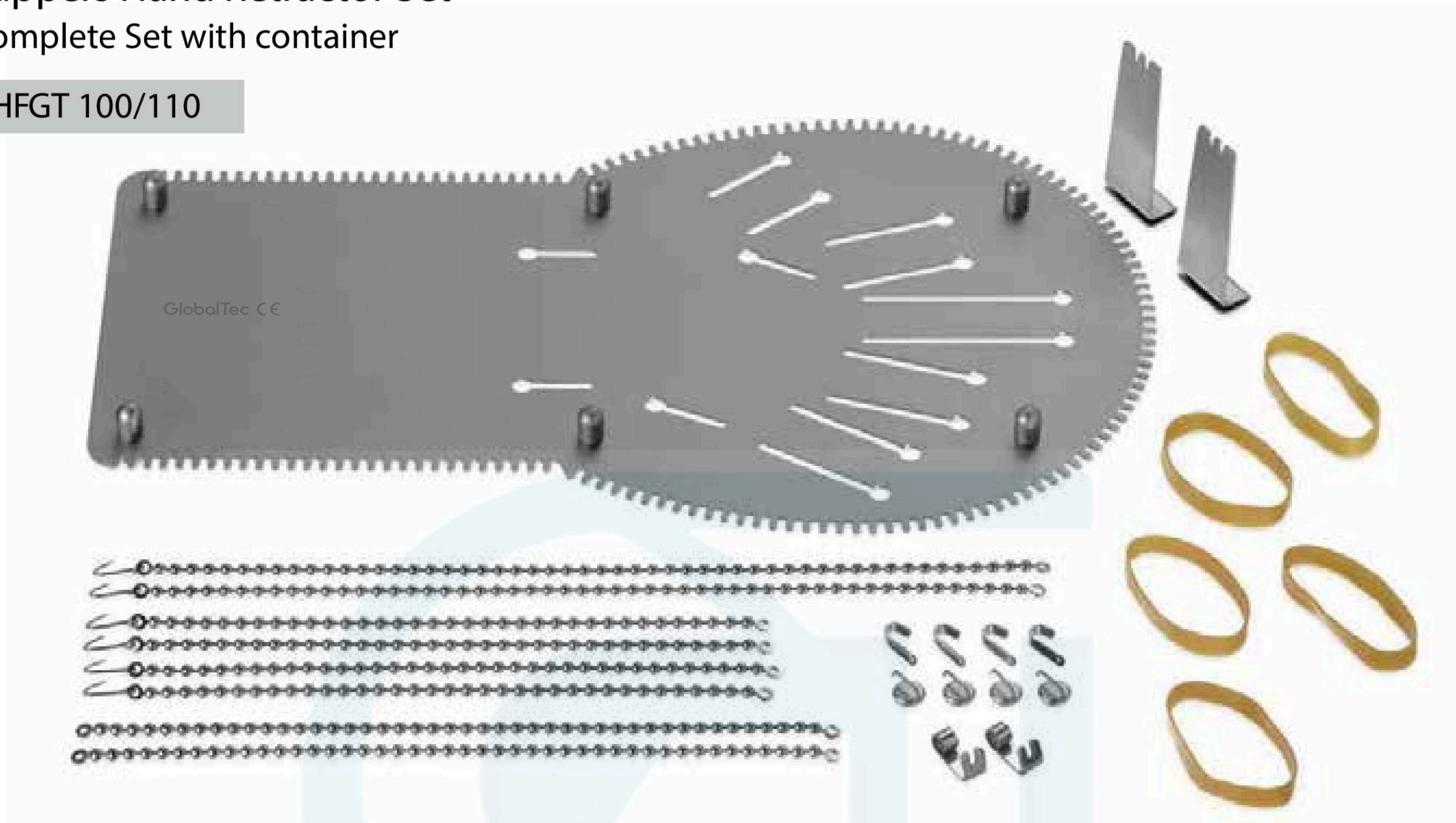

Tuppers Universal Hand Holder and Retractor Set enables the surgeon to fixate the hand in any position needed. The patient's hand is held absolutely firm and allows unhindered work under the microscope. Ball chains of varying length with skin or tendon hooks fixate the hand and lower arm on the Hand Holder. Due to the slots around the Hand Holder, retraction in every direction is possible. Upward retraction is easily achieved with the elevated chain holders. The special container is designed for easy handling and safe storage.

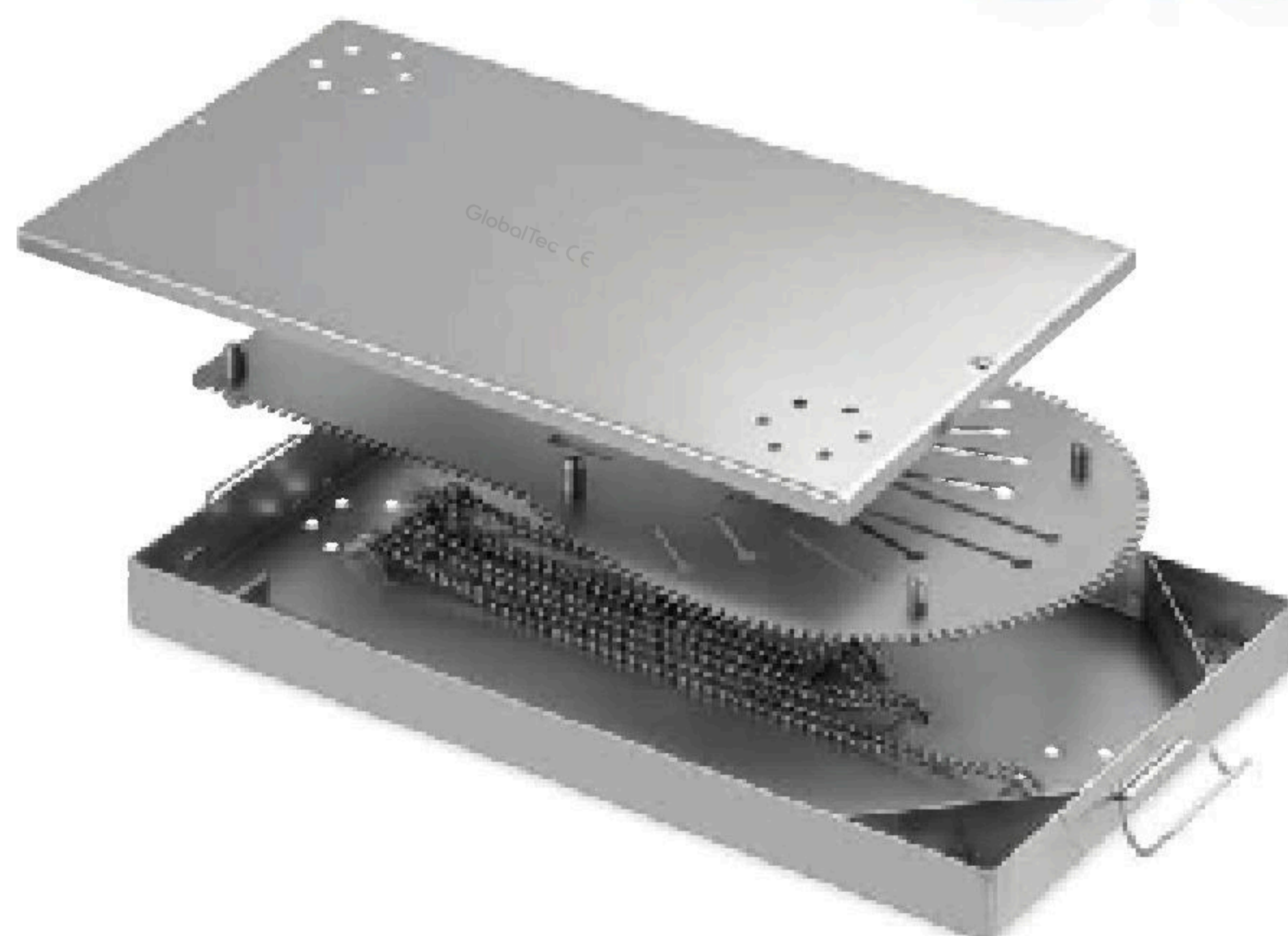

Set consisting of the following instruments:

Qty	Order Code	Description
1	TH-101	Hand Table
2	TH-102	Elevated chain holders
2	TH-103	Chain holder hooks
2	TH-104	Ballchains 32cm,withskin-hooks
4	TH-105	Ballchains 21cm,withskin-hooks
2	TH-106	Ballchains 26cm,forarmandwristfixation
4	TH-107	Tendon hooks 5.0mmwide
4	TH-108	Sliding hooks fortherubberbands
1	TH-109	Set rubber bands 5 pieces

ARTERY FORCEPS

Micro Baby Mosquito Artery Forceps

- Straight
- 10cm/4"

HFGT 5742-10

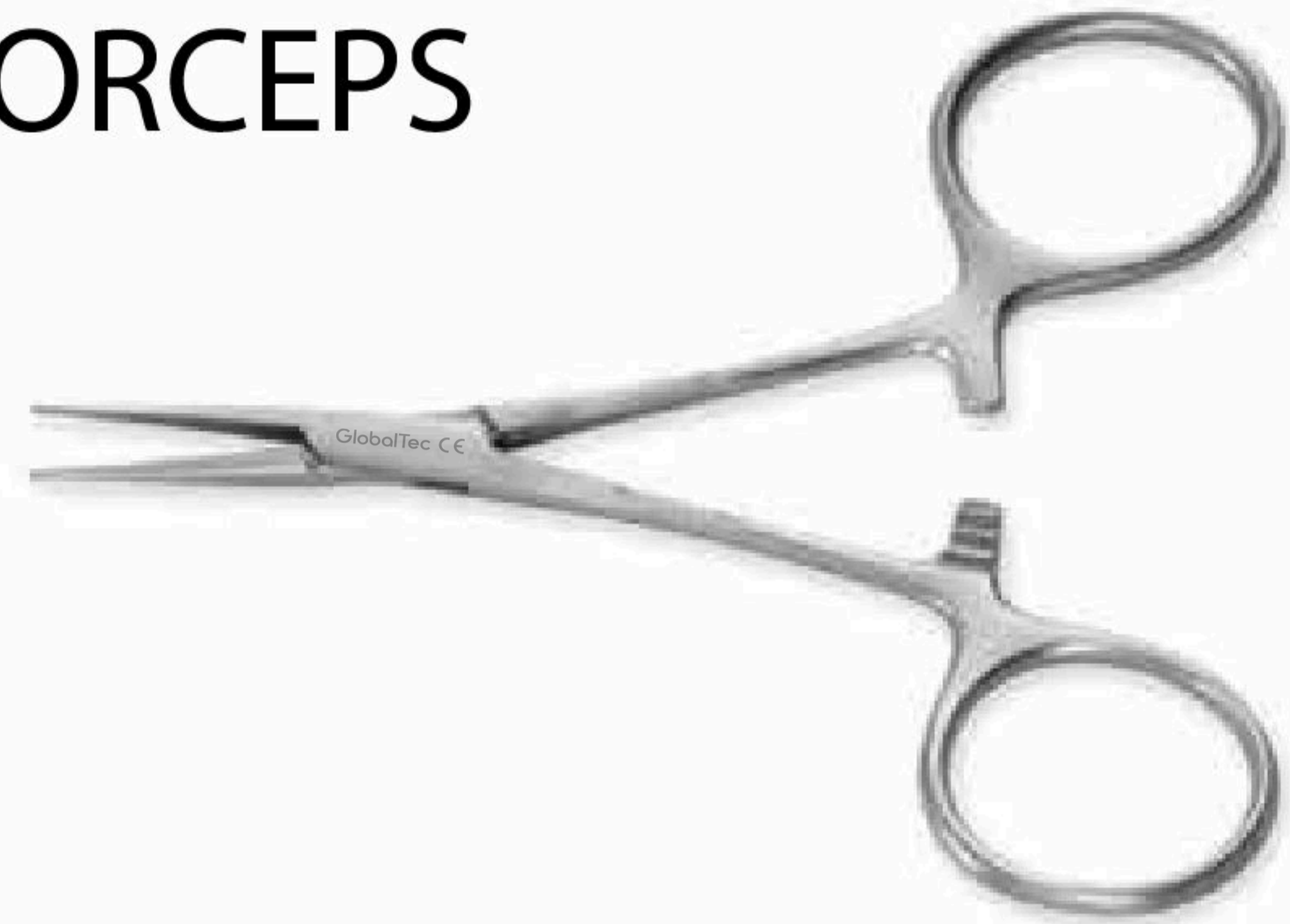

Micro Baby Mosquito Artery Forceps

- Curved
- 10cm/4"

HFGT 5743-10



Micro Baby Mosquito Artery Forceps

- Straight
- 12.5cm/5"

HFGT 5742-12



Micro Baby Mosquito Artery Forceps

- Curved
- 12.5cm/5"

HFGT 5743-12



HAND & FOOT SURGERY
SCALPEL HANDLES & MARKING PENS
Barrons Scalpel Blade Handle No.3

- 13cm/5¼"

HFGT 5001-13

Beaver Blade Holder

- 13cm/5¼"

HFGT 5004-13

Eckoff Mapping Pen

- 14.5cm/5¼"

HFGT 5002-14

Sommerlad Marking Pen

- 15cm/6"

HFGT 5003-15

Stainless Steel Measuring Ruler

Code	Length
HFGT 5005-15	15cm/6"
HFGT 5005-30	30cm/12"

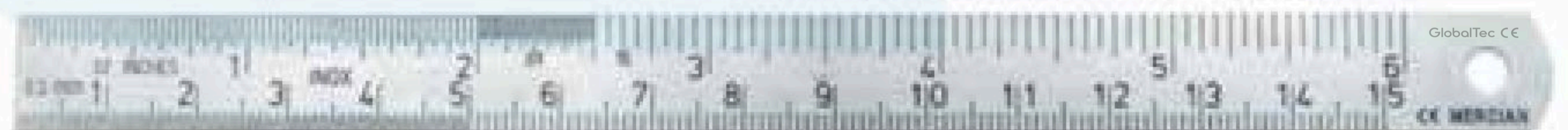
Mitchels Trimmer

- 16cm/6¼"

HFGT 5008-16

Castroviejo Measuring Caliper

- 7cm/2¾"
- Measuring range 0 to 25mm

HFGT 7334-10

Ink Pot

- Stainless Steel

HAAS 5006-99

HAND & FOOT SURGERY
BONE NIBBLERS
Friedman-Pearson Micro Bone Nibbler

- Curved
- 13cm/5¼"

1mm Bite

HFGT 5117-15

Kleinert-Kutz Bone Nibbler

- Curved
- 14cm/4¼"

2mm Bite

HFGT 5118-50

Stellbrink Synovectomy Nibbler

- Curved
- 17cm/6¾"

2mm Bite

HFGT 5118-50

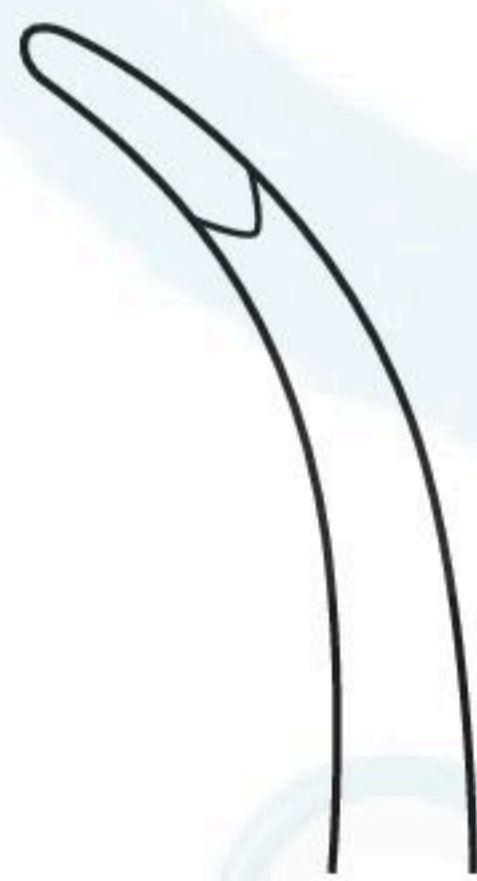
Beyer Bone Nibbler

- Curved
- 17cm/6¾"

2mm Bite

HFGT 5121-17



HAND & FOOT SURGERY

BONE NIBBLERS

Bohler Bone Nibbler

- Curved double action
- 15cm/6"

3mm Bite

HFGT 5120-50



Beyer Bone Nibbler

- Curved double action
- 18cm/7"

4mm Bite

HFGT 1002 -18

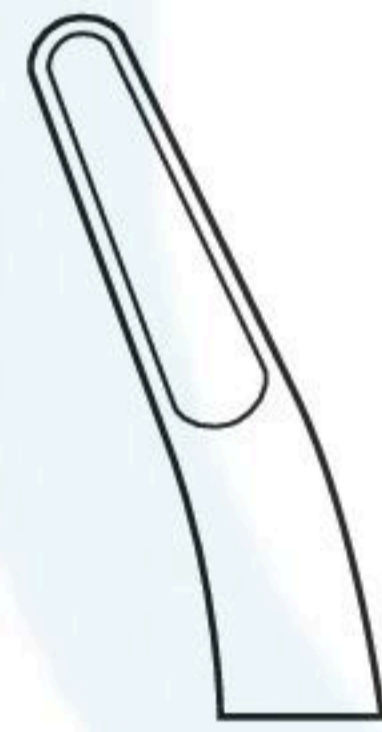

Jansen Bone Nibbler

- Curved double action
- 18cm/7"

5mm Bite

HFGT 1003 -18

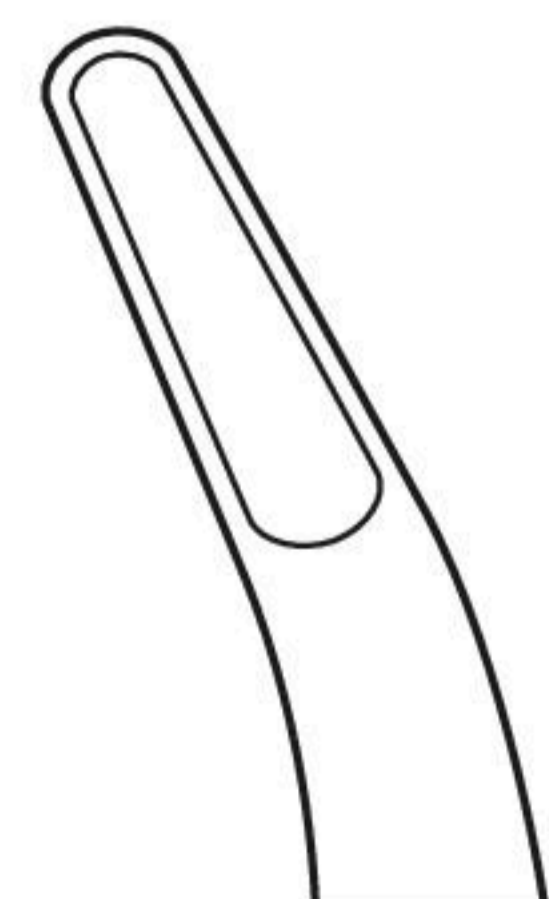

HAND & FOOT SURGERY

BONE NIBBLERS

Bohler Bone Cutters

- Double action
- 15cm/6"

Straight

HFGT 5160-50



Angled

HFGT 5161-50



McIndoe Bone Cutters

- Double action
- 18cm/7"

HFGT 1028 -18

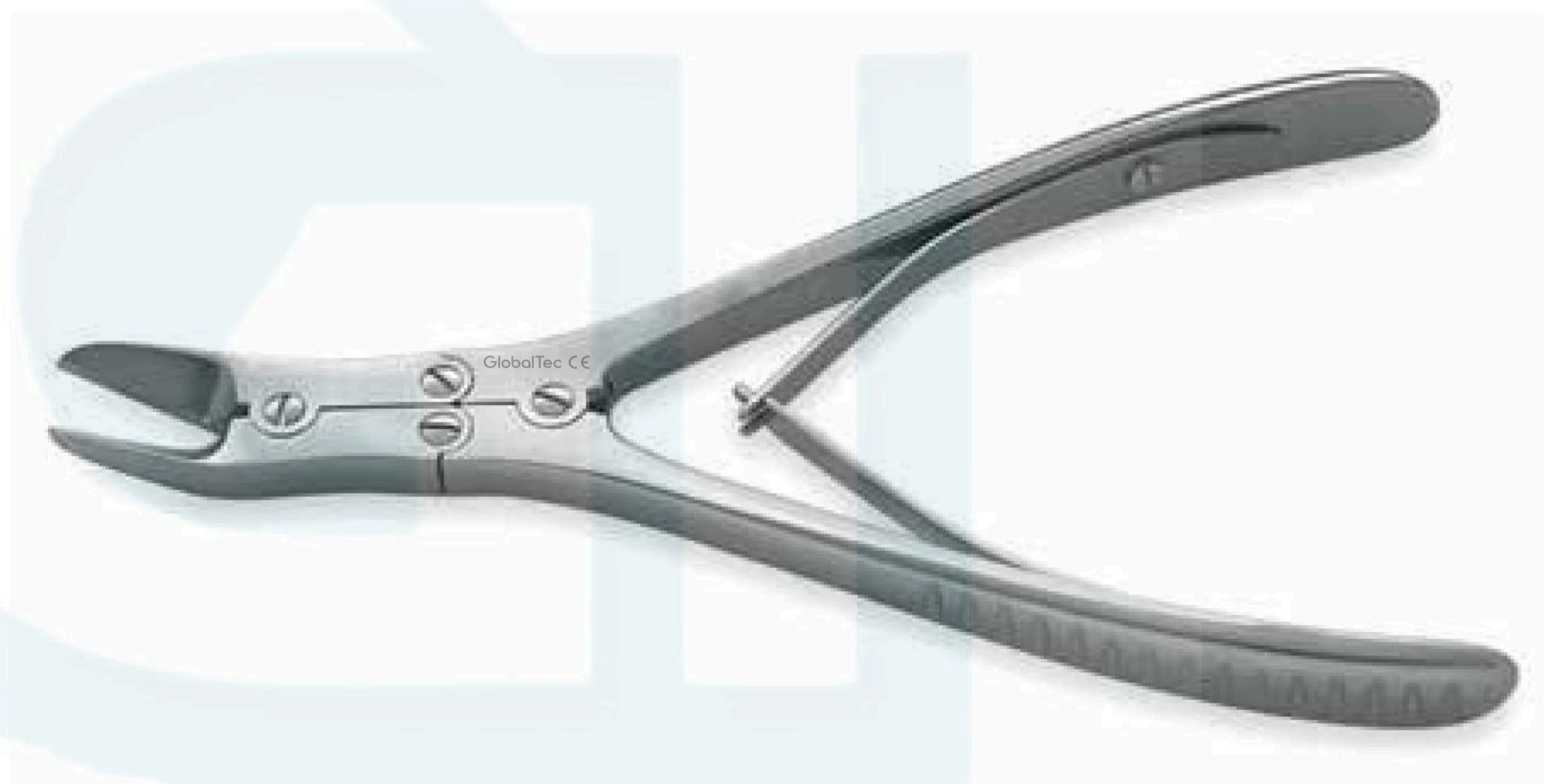

Ruskin-Listons Bone Cutters

- Double action
- 19cm/7½"

Straight

HFGT 5160-50

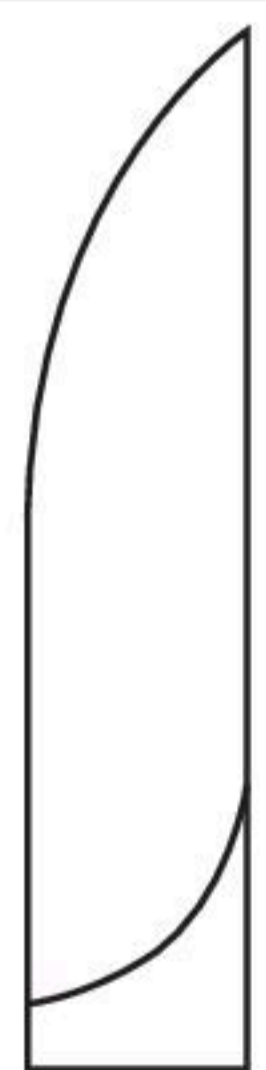

Angled

HFGT 5161-50

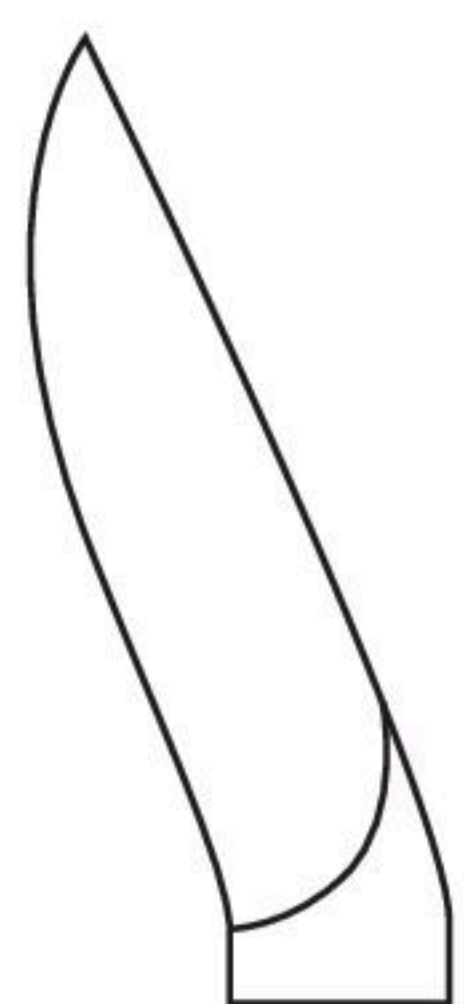

HAND & FOOT SURGERY
MALLETS
Toffee Mallet

- 19cm/7½"
- Head size 22mm Ø
- Weight 165g/6oz

HFGT 5808-21

Mead Mallet

- Interchangeable delrin discs
- 18cm/7"
- Head size 26mm Ø
- Weight 320g/11¼oz

HFGT 5808-21

Ultra Fine Mallet

- 17cm/6¾"
- Head size 20mm Ø
- Weight 145g/5oz

HFGT 5804 -23

Mallet with Tufnol Handle

- 23cm/9"
- Head size 35mm Ø
- Weight 550g/20oz

HFGT 5804 -23

London Splint Mallet

- 18cm/7"
- Head size 30mm Ø
- Weight 450g/16.2oz

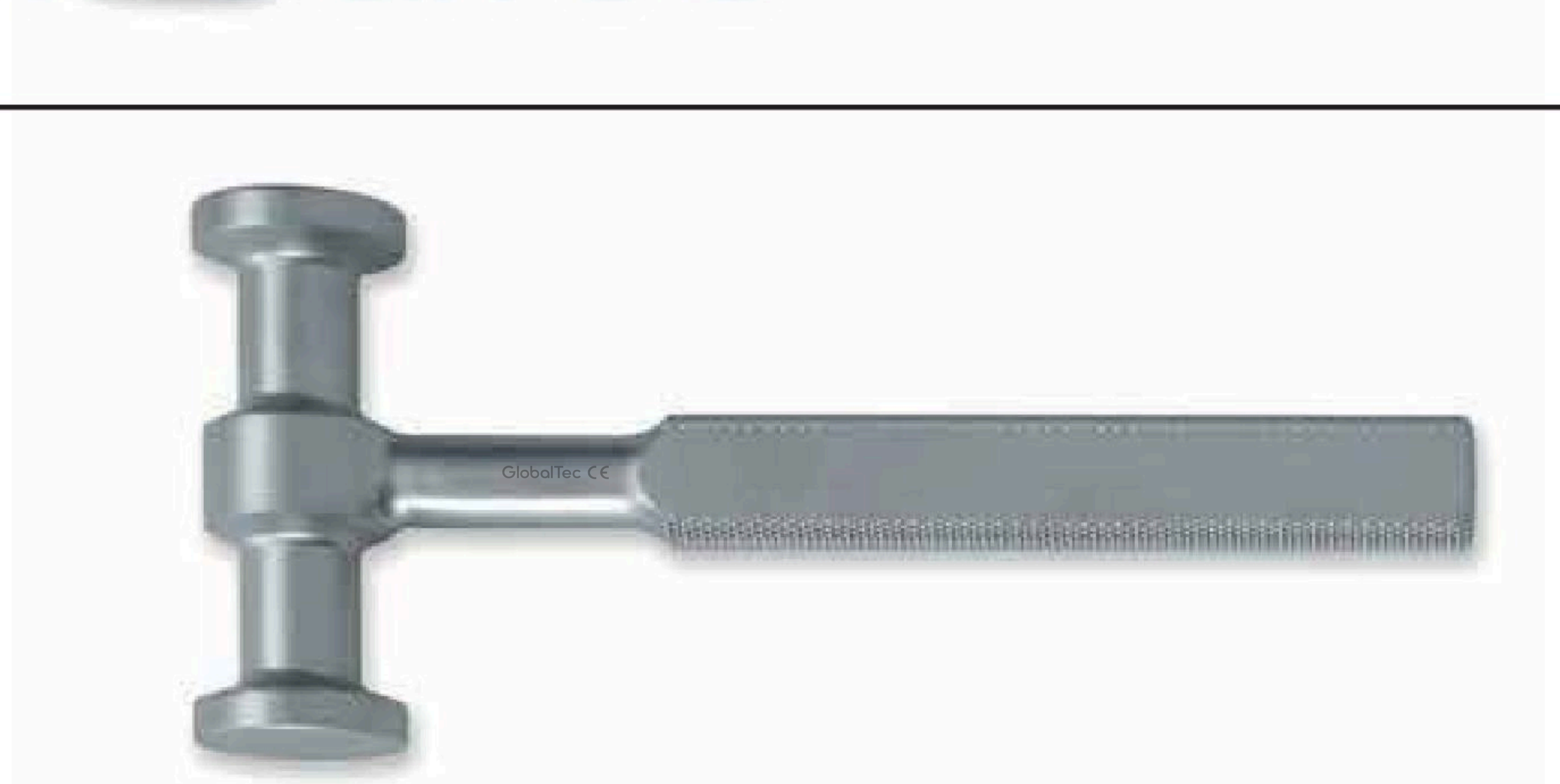
HFGT 5802 -18



HAND & FOOT SURGERY

OSTEOTOMES, CHISELS & GOUGES

Mini-Lambotte Osteotomes

- 12.5cm/5"

HFGT 5270 -28	Set of 5 sizes 2mm to 8mm
HFGT 5270 -02	2mm
HFGT 270 -04	3mm
HFGT 5270 -06	4mm
HFGT 5270 -08	6mm
HFGT 5270 -10	8mm

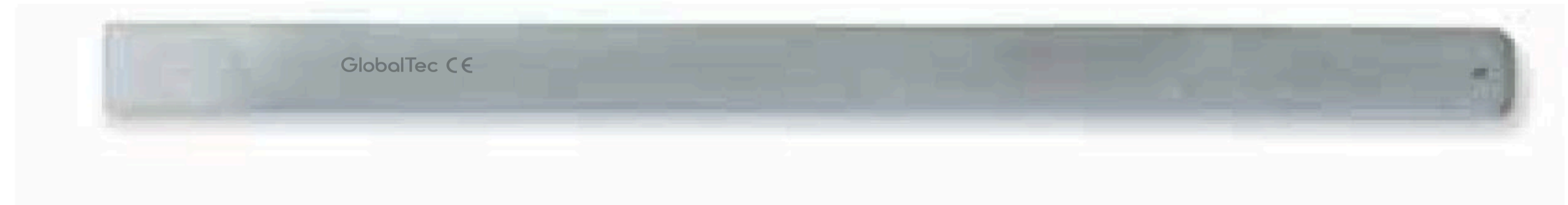

Sheehan Osteotomes

- 15cm/6"

HFGT 5280 -28	Set of 5 sizes 2mm to 8mm
HFGT 5280 -02	2mm
HFGT 5280 -04	4mm
HFGT 5280 -06	6mm
HFGT 5280 -08	8mm
HFGT 5280 -10	10mm



Carroll Osteotomes

- 14.5cm/5¾"

HFGT 5290 -03	3mm
HFGT 5290 -06	6mm
HFGT 5290 -10	10mm
HFGT 5290 -13	13mm



Partsch Chisel

- 13cm/5¼"

HFGT 5260 -02	2mm
HFGT 5260 -03	3mm
HFGT 5260 -04	4mm
HFGT 5260 -05	5mm
HFGT 5260 -06	6mm
HFGT 5260 -07	7mm
HFGT 5260 -08	8mm



HAND & FOOT SURGERY

OSTEOTOMES, CHISELS & GOUGES

Ultra Fine Osteotomes (Titanium Nitrate Coated)

- 16cm/6¼"

HFGT 5230 -48	Set of 6 sizes 2mm to 12mm
HFGT 5230 -02	2mm
HFGT 5230 -04	4mm
HFGT 5230 -06	6mm
HFGT 5230 -08	8mm
HFGT 5230 -10	10mm
HFGT 5230 -12	12mm



Mini-Lexer Osteotomes with Tufnol Handle

- 18cm/7"

HFGT 5250 -48	Set of 5 sizes 2mm to 10mm
HFGT 5250 -02	2mm
HFGT 5250 -04	4mm
HFGT 5250 -06	6mm
HFGT 5250 -08	8mm
HFGT 5230 -10	10mm



Mini-Lexer Gouge with Tufnol Handle

- 18cm/7"

HFGT 5290 -03	3mm
HFGT 5290 -06	6mm
HFGT 5290 -10	10mm
HFGT 5290 -13	13mm



Bone Tampers

- 18cm/7"

HFGT 5004 -02	2mm	#
HFGT 5004 -03	3mm	#

HFGT 5004 -04	4mm	⊗
HFGT 5004 -05	5mm	⊗

HFGT 5004 -06	6mm	⊗
HFGT 5004 -08	8mm	⊗



BONE ELEVATORS

Adson Periosteal Elevator

- 16cm/6¼"
- Curved blunt



	Width
HFGT- 3055 -16	5mm
HFGT 3055 -16	7mm

Pennybacker Periosteal Elevator

- 16cm/6¼"
- Curved sharp



	Width
HFGT 3063 -16	4mm
HFGT 3066 -16	6mm
HFGT 3068 -16	8mm

Bone Raspatory with Tufnol Handle

- 19cm/7½"



Straight	Width
HFGT 7016 -19	6mm

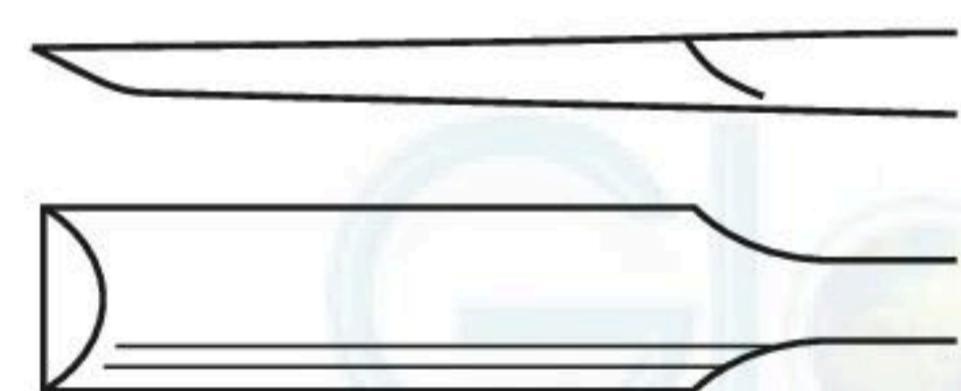

Curved	Width
HFGT 7023 -19	3mm
HFGT 7026 -19	6mm

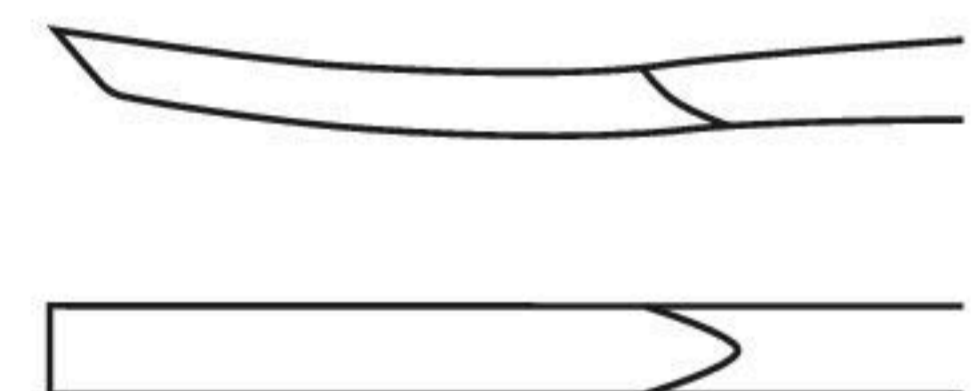

Bone Raspatory with Tufnol Handle

- 19cm/7½"

Straight	Width
HFGT 3001 -15	12 mm

Straight	Width
HFGT 3002 -15	12 mm



*illustrated

HAND & FOOT SURGERY
BONE ELEVATORS
Mini Bone Lever

- 14cm/5½"
- 2-8mm width

HFGT 5830-14

Hohmann Style Mini-Bone Lev

- 16cm/6¼"
- 6mm width

HFGT 5831-16

Phalangeal Lever

- 15cm/6"
- 5mm width

HFGT 5832-16

Buck-Gramcko Lever

- 15cm/6"
- 7.5mm width

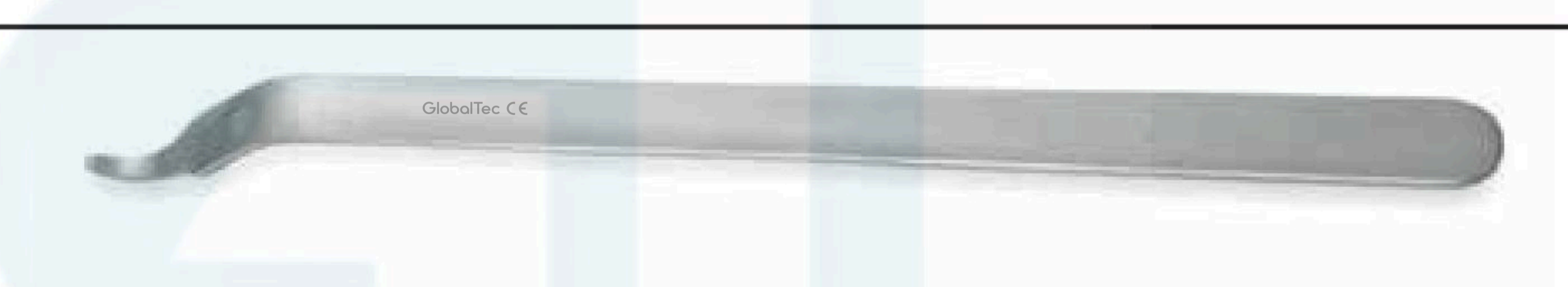
HFGT 5833-15

Mini-Cobra Bone Lever

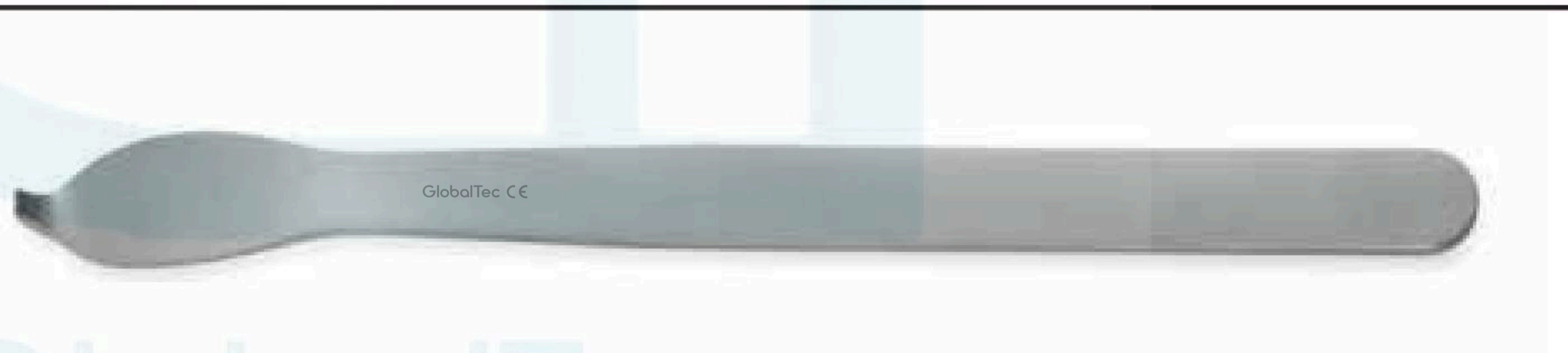
- 16cm/6¼"
- 15mm width

HFGT 5834-16

McGlamry Metatarsal Elevator

- 17cm/6½"

HFGT 5835-10 9mm Width

HFGT 5835-12 11mm Width

HFGT 5835-14 13mm Width

HFGT 5835-16 15mm Width

HFGT 5835-19 19mm Width



HAND & FOOT SURGERY

BONE CURETTES & RASPS

Martini Mini Curette

- 13.5cm/6¼"

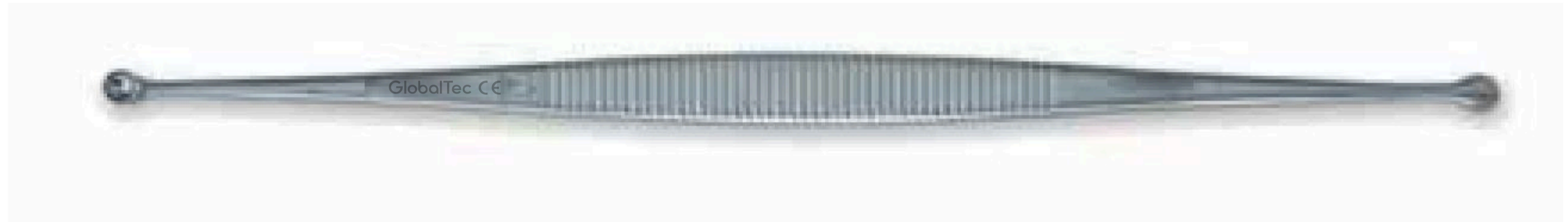
HFGT 5412-13



Jansen Curette

- 16cm/6¼"

HFGT 5432-15



Bruns Curette

- 17cm/6¾"



Cup size 0000

HFGT 5414-17



Cup size 000

HFGT 5413-17



Cup size 00

HFGT 5412-17



Cup size 0

HFGT 5411-17

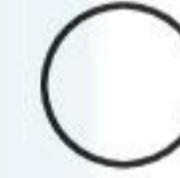

Curette with Tufnol Handle

- 19cm/6½"



Cup size 0000

HFGT 5404-19



Cup size 000

HFGT 5403-19



Cup size 00

HFGT 5402-19



Cup size 0

HFGT 5401-19



Bone Rasp with Finger Ring

- 15cm/6"

HFGT 5382-01



HAND & FOOT SURGERY
DISSECTORS
Swedish Dissector

- 18cm/7"

HFGT 9201-18

Howarth Elevator

- 21.5cm/8½"

HFGT 9207-21

MacDonald Elevator/Dissector

HFGT 7105 -19

Size

8cm/7"

HFGT 9206 - 23

23cm/9"

Watson Cheyne Dissector

HFGT 7203 -18

Size

8cm/7"

HFGT 9203 - 23

23cm/9"

HFGT 9203 - 25

25.5cm/10"

Freers Elevator/Dissector

- 18.5cm/7¼"

HFGT 7602 -18



HAND & FOOT SURGERY
BONE HOLDING FORCEPS
Bone Holding Forceps

- 14cm/5½"

HFGT 5021-14

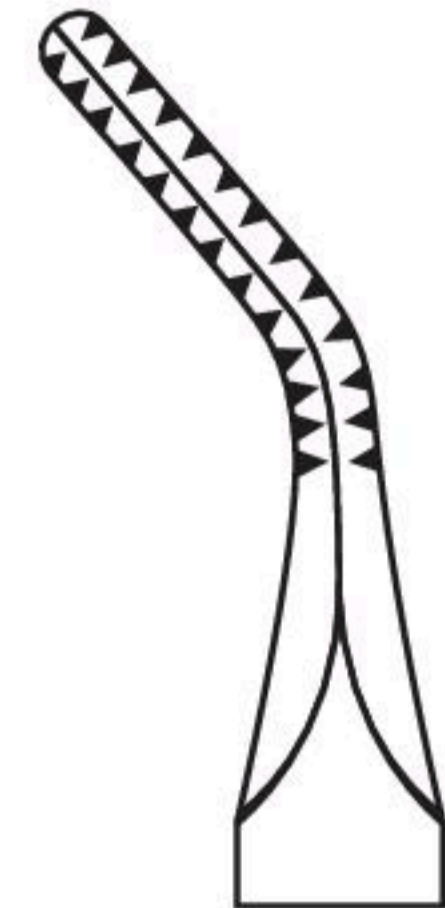
Phalanx Holding Forceps

- 14cm/5½"

HFGT 5031-14

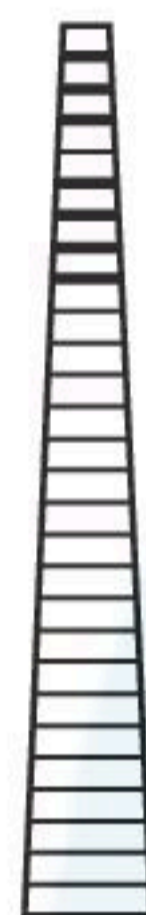

Langenbeck Bone Holding Forceps

- 20cm/8"

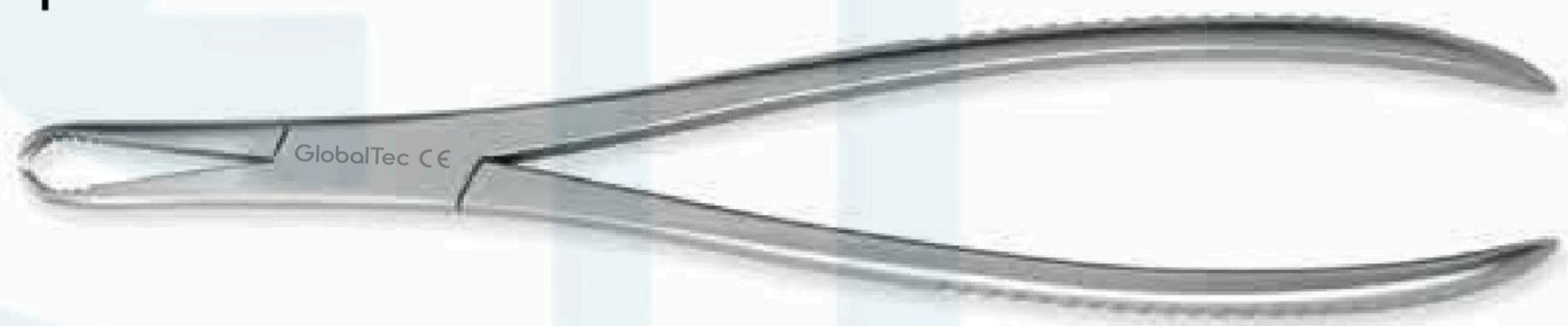
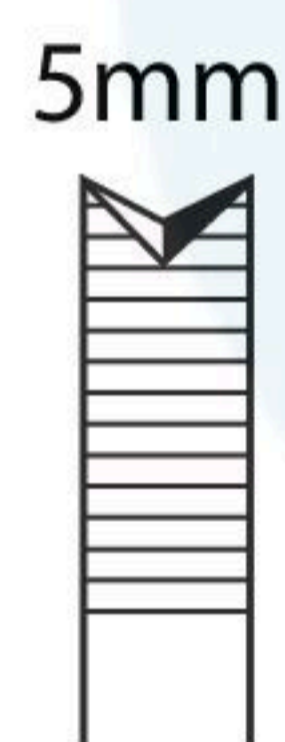
HFGT 5120-05

Bone Reposition Forceps for small fragments

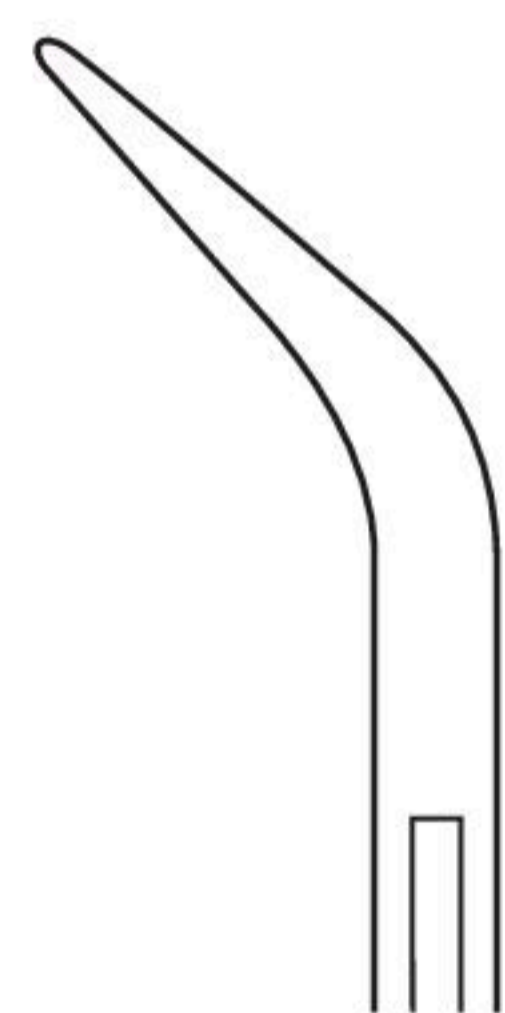
- 13.5cm/6¼"

Bone Reposition Forceps for small fragments

- 14cm/5½"

HFGT 5051-09

for 0.9mm wire

HFGT 5051-12

for 1.2mm wire

HFGT 5051-16

for 1.6mm wire

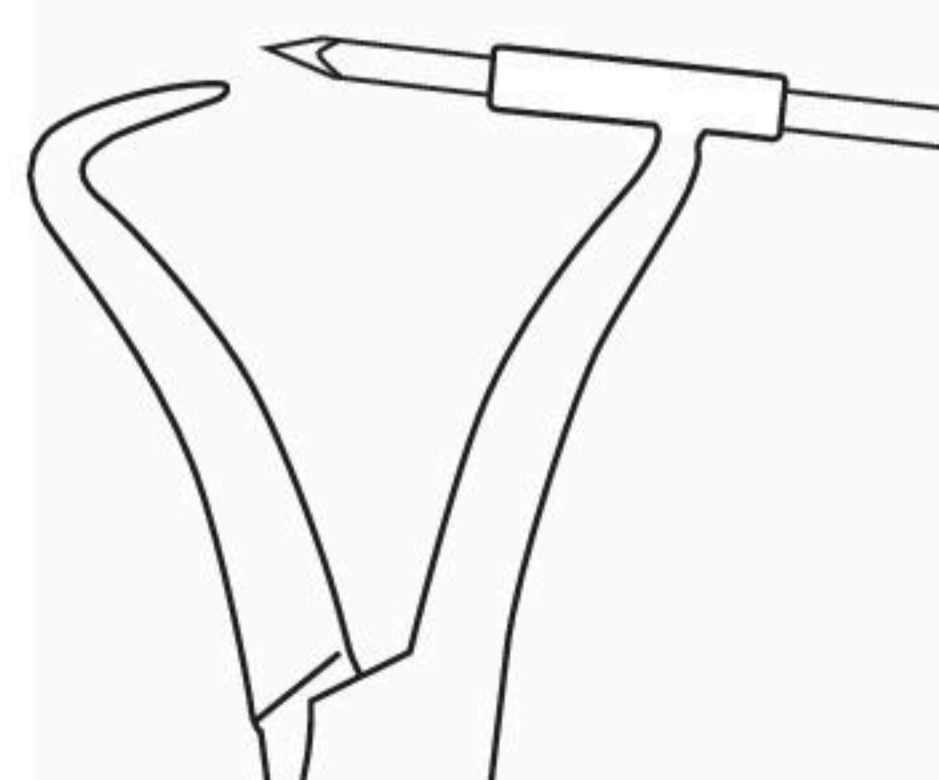

These Bone Repositioning Forceps include a wire guide allowing the K-wire to be accurately implanted in the Bone. We offer sizes to take small, medium and large Kirschner wires.

HAND & FOOT SURGERY

BONE SPREADERS & CAMPS

Scaphoid Spreader - Fine Pattern

- 14cm/5½"
- 1x2 prongs

6mm

HFAS 5131-14



Scaphoid Spreader - Standard Pattern

- 14cm/5½"

6mm

HFAS 5134-14

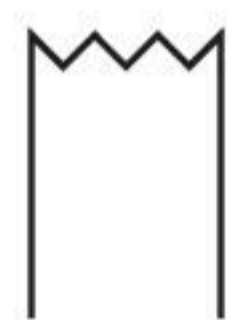

Baby Inge Lamina Spreader

- 18cm/7"

7mm

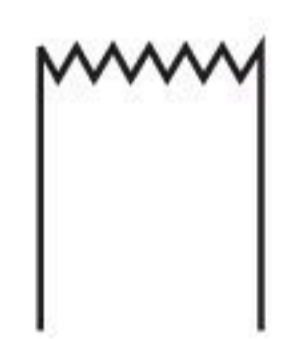

HFAS 5134-18

Toothed

7mm

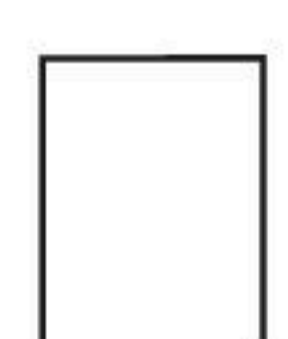

HFAS 5134-185

Smooth

7mm



HFAS 5134-18X

Cross Serrated



Ikuta Bone Clamp

- 13.5cm/4¾"
- Toothed 2x2 jaws
- With ratchet

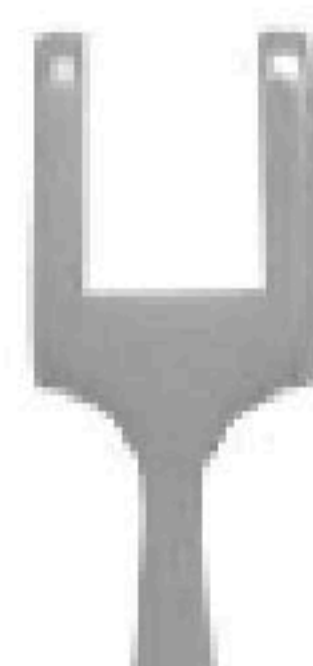

HFAS 5055-12

Wide jaw*
8mm width



HFAS 5050-12

Narrow jaw
4mm width

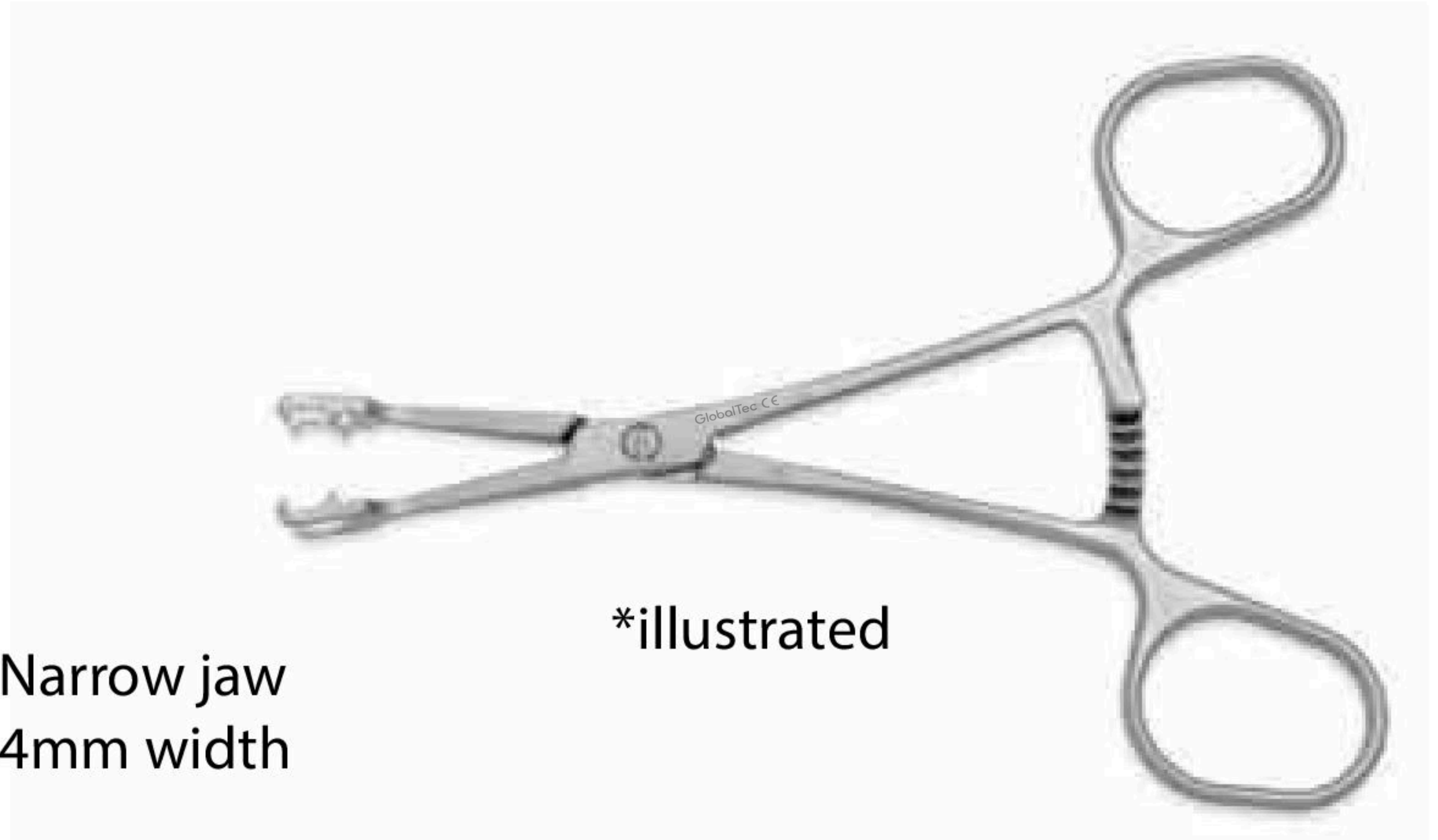

*illustrated

HAND & FOOT SURGERY

BONE SPREADERS & CAMPS

Scaphoid Spreader - Fine Pattern

- 14cm/5½"
- 1x2 prongs

6mm

HFGT 5131-14

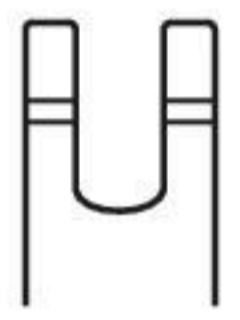

Scaphoid Spreader - Standard Pattern

- 14cm/5½"

6mm

HFGT 5134-14

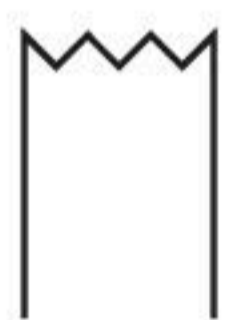

Baby Inge Lamina Spreader

- 18cm/7"

7mm



HFGT 5134-18

Toothed

7mm

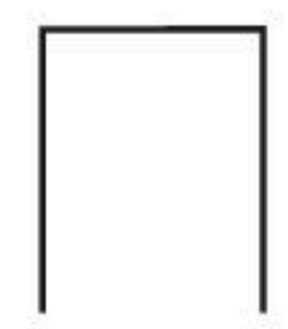

HFGT 5134-185

Smooth

7mm

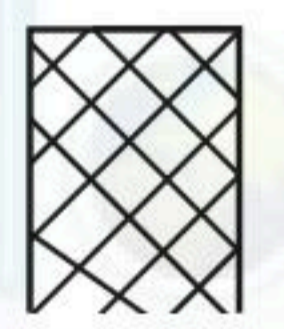

HFGT 5134-18X

Cross Serrated



Ikuta Bone Clamp

- 13.5cm/4¾"
- Toothed 2x2 jaws
- With ratchet



HFGT 5055-12

Wide jaw*
8mm width



HFGT 5050-12

Narrow jaw
4mm width

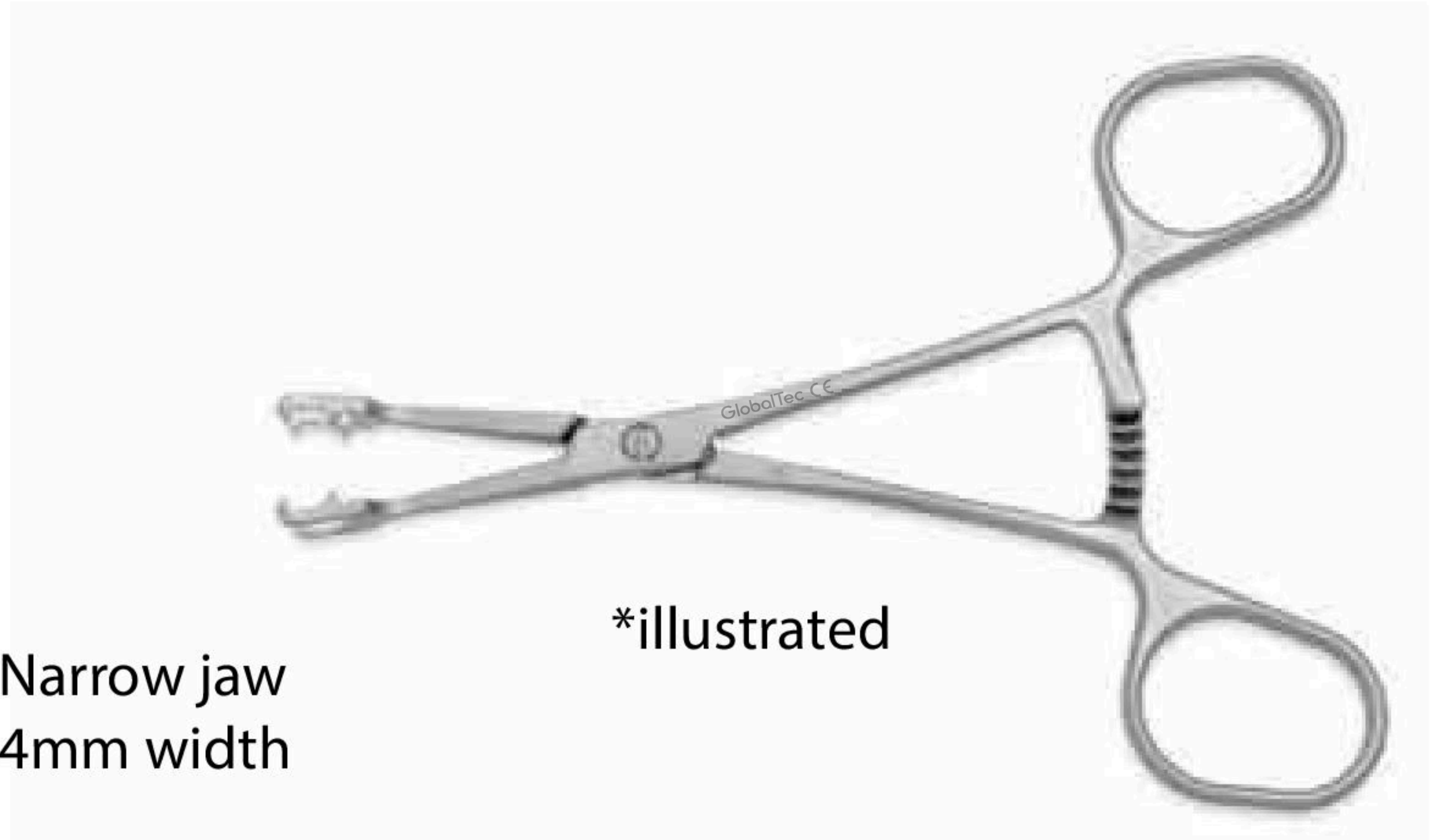

*illustrated

HAND & FOOT SURGERY
WIRING INSTRUMENTS
Slim Nose Wire Twisters

- 19cm/7½"

HFGT 7645 -19

Needle Nosed Locking Pliers

Length

200-514-220	22cm/8¾"	Small
200-515-250	25cm/9¾"	Medium
200-516-300	30cm/11¾"	Large

- A very useful instrument for orthopaedic surgery allowing the surgeon to securely clamp on to wires and implants.

Combined Wire Cutters & Pliers

- 18cm/7"
- Suitable for wires up to 1.6mm

200-514-220
200-512-185

Orthopaedic Locking Grips

- 18cm/7" Length

Length

200 - 511-180	18cm/7"	Small
200-511-200	20cm/8"	Medium
200 - 511- 240	24cm/9½"	Large



HAND & FOOT SURGERY
TENDON SURGERY
Tendon Interlacing Forceps

- 15cm/6"



Straight

HFGT 7645 -19



Curved

HFGT 7645 -19



- The pointed tip separates the Tendon without causing splits. The jaws grasp and secure a Tendon Stump pulling it back through the tendon body.

Carroll Tendon Retriever

- Curved
- 11cm/4¼"

HFGT 5679-11



Kleinert-Kutz Tendon Retriever

- 21cm/8¼"
- 2mm jaws
- Flexible shaft

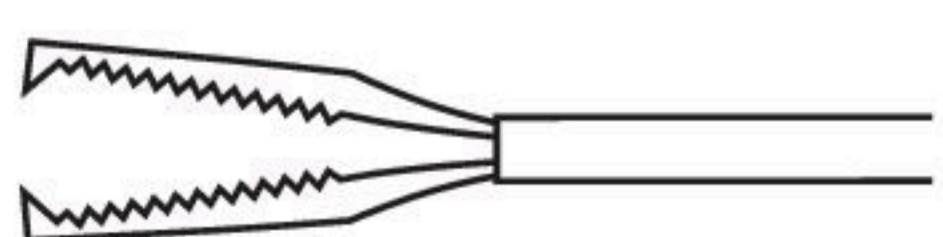
HFGT 5814-02

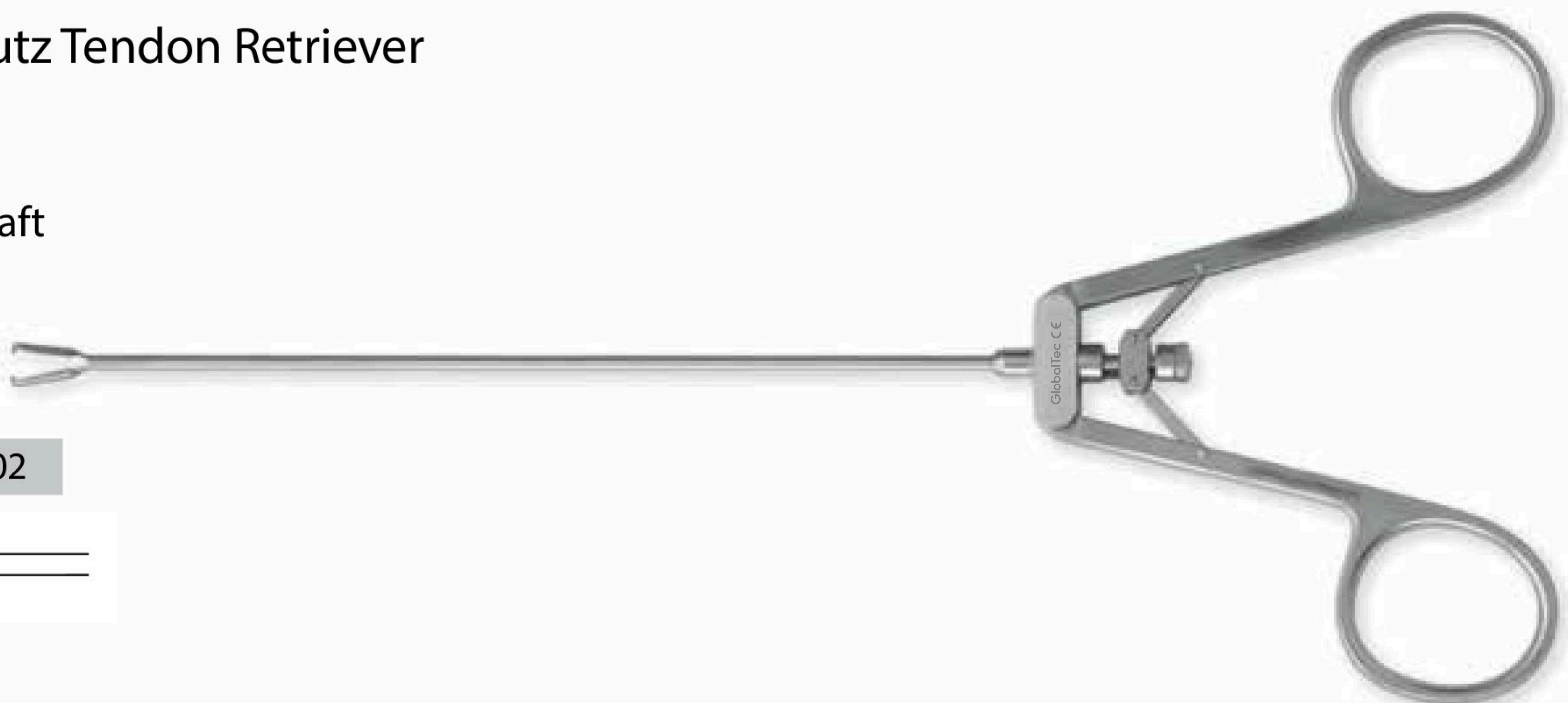

1 x 2 Teeth



HAND & FOOT SURGERY
TENDON SURGERY
Anderson-Brand Tendon Retriever

- 15cm/6"

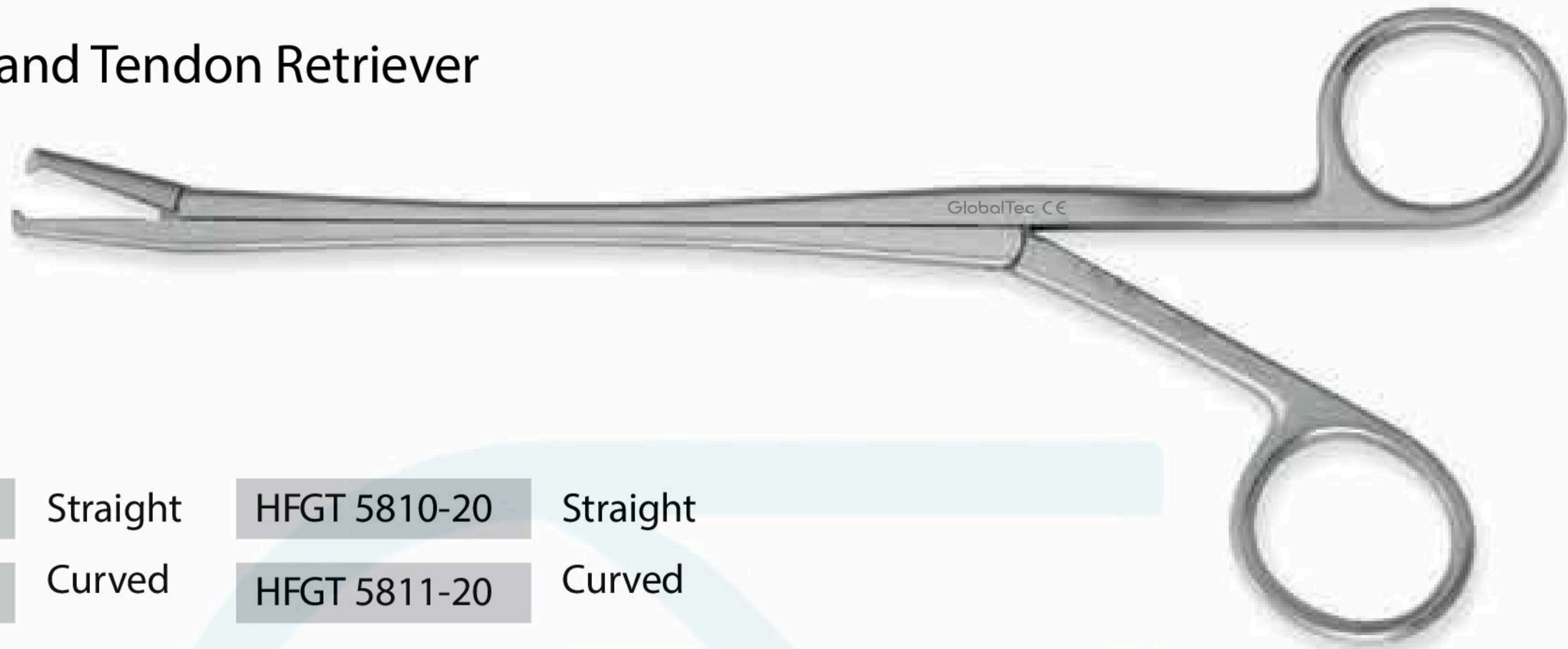

- | | | | |
|--------------|----------|--------------|----------|
| HFGT 5810-15 | Straight | HFGT 5810-20 | Straight |
| HFGT 5811-15 | Curved | HFGT 5811-20 | Curved |

Buck-Gramcko Tendon Retriever

- 20cm/8"
- 2 x 3 teeth on serrated jaws

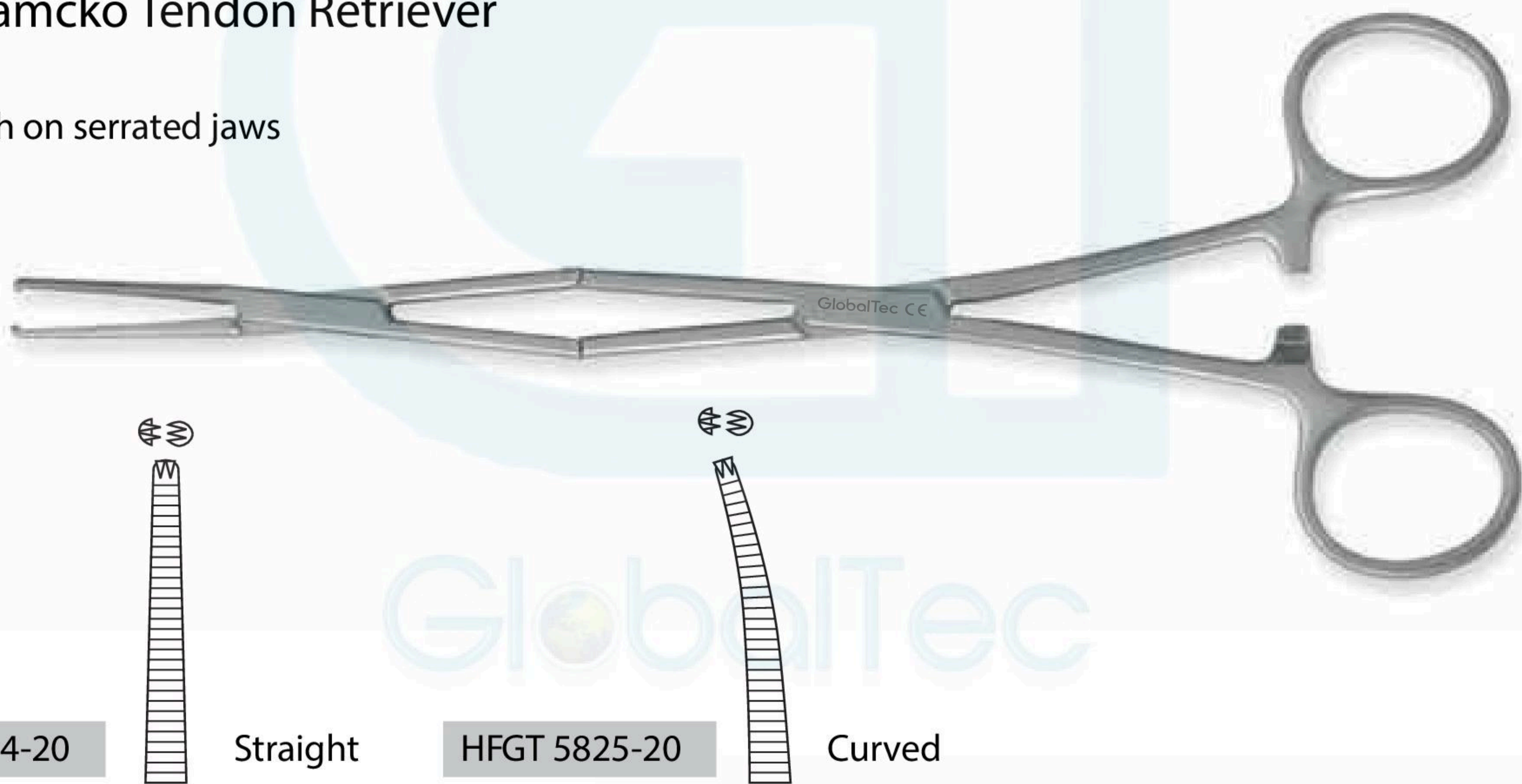

- | | | | |
|--------------|--|--------------|--|
| HFGT 5824-20 |  Straight | HFGT 5825-20 |  Curved |
|--------------|--|--------------|--|

Steinmann Tendon Holding Forceps

- 13cm/5 1/8"
- with adjustable grub screw

HFGT5864-13

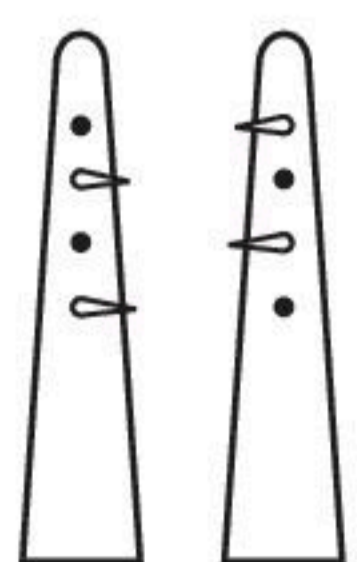

Teeth engage in opposing jaws



TENDON SURGERY

Tendon Strippers

- 28cm/11"



Closed Ring Style

Closed Ring Style

- No requirement to cut the Tendon

HFGT 5811-03 3mm inside diam.



HFGT 5809-03 3mm inside diam.



HFGT 5811-04 4mm inside diam.



HFGT 5809-04 4mm inside diam.



HFGT 5811-05 5mm inside diam.



HFGT 5809-05 5mm inside diam.



HFGT 5811-06 6mm inside diam.



HFGT 5809-06 6mm inside diam.



Fischer Tendon Stripper

- 31cm/12¼"

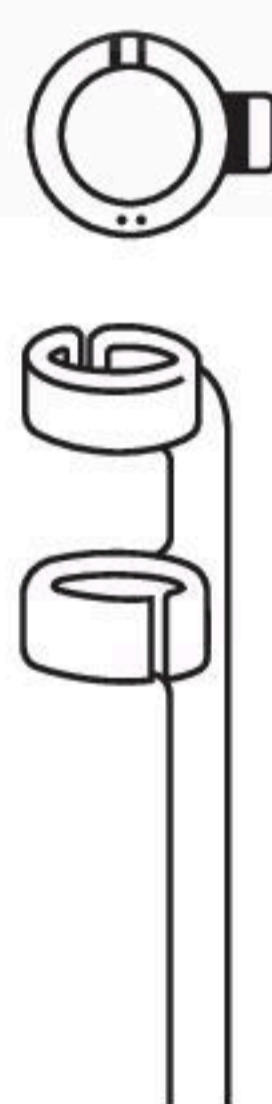

Diameter 4mm

HFGT 5812-04

Larson Tendon Holding Forceps

- 10cm/4"

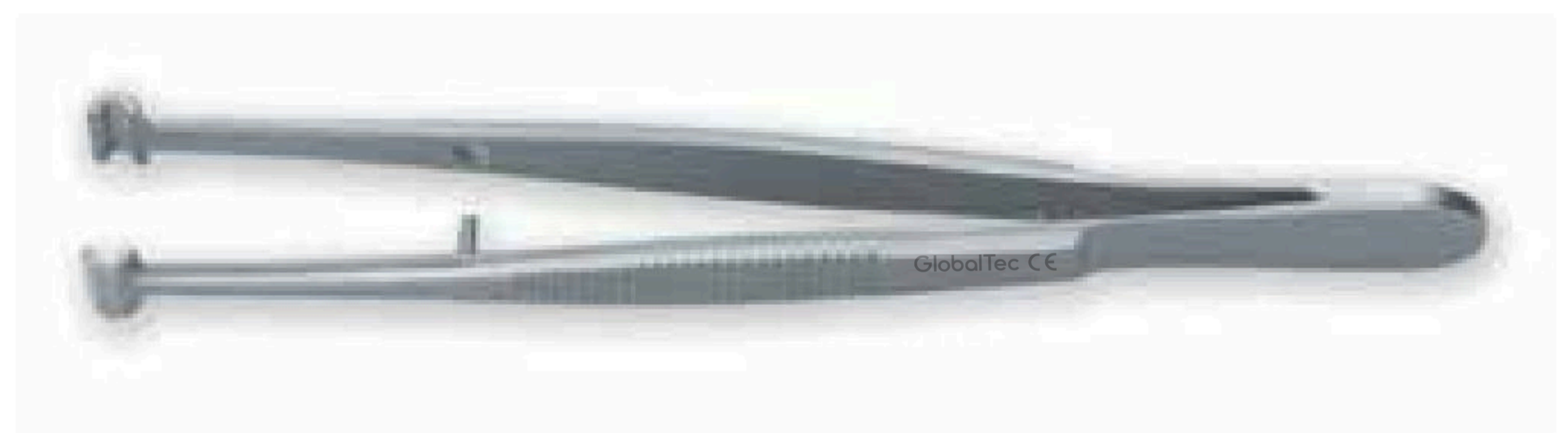

HFGT 5810-02 2mm

HFGT 5810-03 3mm

HFGT 5810-04 4mm

HFGT 5810-05 5mm

HAND & FOOT SURGERY
TENDON SURGERY
Meyer Nerve/Tendon Holding & Trimming Instrument Set
NHS -1

Set of Six Forceps with Container and Blade Holders.
CBS - 35 Box of Blades to fit Meyer Set.

Set consisting of the following instruments:

Qty	OrderCode	Description
1	SHF-2.0	Holding Forceps
1	SHF-3.0	Holding Forceps
1	SHF-4.0	Holding Forceps
1	SHF-5.0	Holding Forceps
1	SHF-6.0	Holding Forceps
1	SHF-7.0	Holding Forceps
1	SHF-12	Bladeholder
1	HFN-913	Sterilization Box



**BHS-12
Blade Holder**

Sterile Blades
• Box of 12
straight blades

HFS-35

This set was developed to allow the surgeon to hold securely and trim the nerve ends with the correct size holding forceps avoiding trauma to the nerve. There is minimal loss of nerve end with this technique.

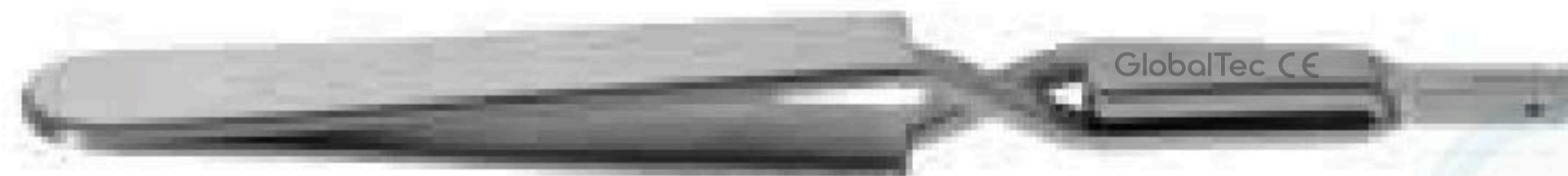
Holding Forceps

SHF-0.5 Ø 0.5mm

SHF-1.0 Ø 1.0mm

SHF-1.5 Ø 1.5mm

SHF-1.5 Ø 2.0mm

SHF-3.0 Ø 2.5mm

SHF-3.0 Ø 3.0mm

SHF-3.5 Ø 3.5mm

SHF-4.0 Ø 4.0mm

SHF-5.0 Ø 5.0mm

SHF-6.0 Ø 6.0mm

SHF-7.0 Ø 7.0mm

HAND & FOOT SURGERY

HAND SURGERY INSTRUMENTS SETS

The GLOBALTECH Hand Set gives the consultant a range of instrumentation for both Soft Tissue and Bone Surgery, presented in an instrument container.

The set can be ordered as a Basic Set or the extended set with further Bone and Tendon Instruments.



HAND & FOOT SURGERY
HAND SURGERY INSTRUMENTS SETS
GT Basic Hand Set
HFGT 5000-00

Set consisting of the following instruments:

Qty	Order Code	Description
1	E4026/5D	Sterilising Container with doublerack
1	EA7633 -11	Stevens Tenotomy Scissors Curved 4½"
1	703 DE-12	Derf TC Needle Holder 4¾"
1	HF5118-50	Kleinert Kutz Bone Nibbler 5½"
1	HF5200-70	Alm S/R Retractor 3"
1	HF5701-10	Weitlaner S/R Retractor 2x3 Blunt 4¼"
1	HF5130 -12	Micro Adson Forceps 1 x 2 Teeth
1	HF5035 -12	Micro Adson Forceps Non Toothed
1	HF5382-01	Bone Rasp Straight with Finger Ring
2	HF5055-01	Kleinert Kutz Skin Hooks
2	HF5402-10	Joseph Double Hooks 10mm
2	HF5251- 01	Single Blunt Hook
2	HF5235 -12	Saddle Hooks 12mm
2	HF5242 -10	Mini Langenbeck Retractors
2	HF5252-03	Catspaw Retractors 3 - Prong
5	HF5270-28	Mini-Lambotte Osteotomes 2, 3, 4, 6 & 8mm
1	HF5432 -10	Jansen Mini Bone Curette
2	HF5830 -14	Mini Bone Levers
1	HF7602 -18	Freer Dissector
1	HF5808 -21	Toffee Hammer

GT Extended Hand Set
HAGT 5000-05

Extended Hand Set includes the above plus the following instruments:

Qty	Order Code	Description
1	EA7643 -13	Jameson-Werber Scissors Curved 5¼"
1	70-02-41	Bipolar Forceps 4"
1	37- 01- 35L	Bipolar Lead - Banana Plug Fitting
1	HF5120 -50	Bohler Bone Nibbler Curved
1	HF5161-50	Bohler Bone Cutter Angled
1	8-810 E-18	Muller-Claus Wire Cutters
1	8-818 E-18	Wire Twisters Muller-Claus
1	HF5679-11	Carroll Tendon Forceps
1	HF5254-15	Tendon Braiding Forceps Straight
1	HF5255-15	Tendon Braiding Forceps Curved

HAND & FOOT SURGERY
MICRO SURGERY INSTRUMENTS
Vessel Dilator Angled

- 11cm/4¼" length
- Tips 0.2mm Ø

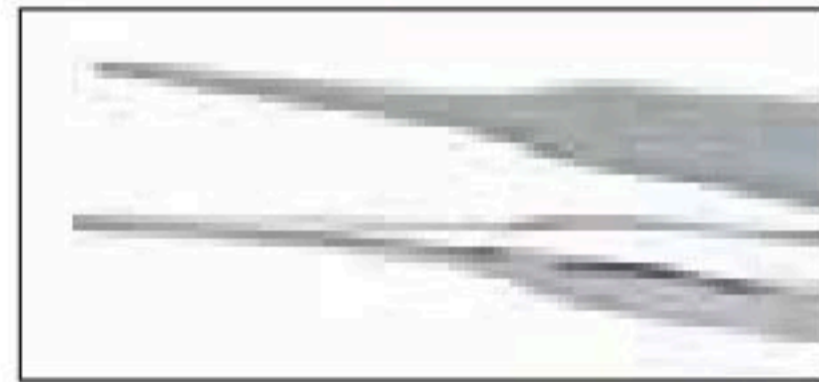
HFDGT - 5a.2

Vessel Dilator Angled

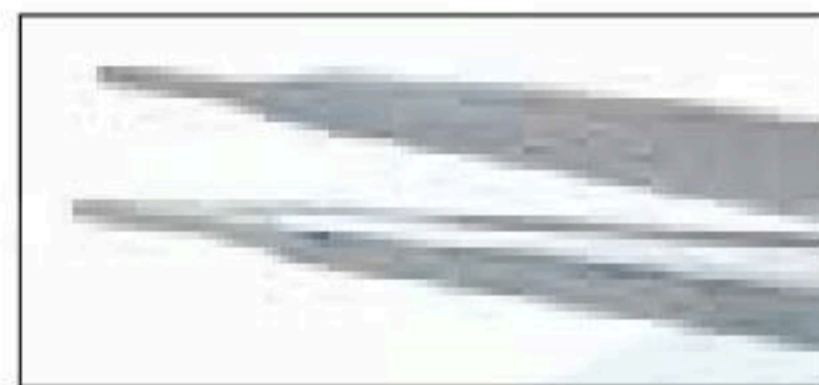
- 11cm/4¼" length
- Tips 0.3mm Ø

HFDGT - 5a.3

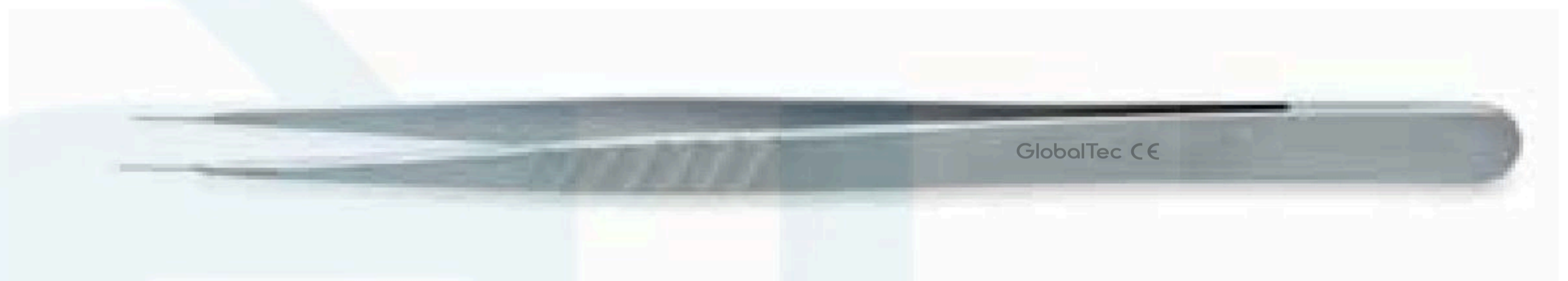
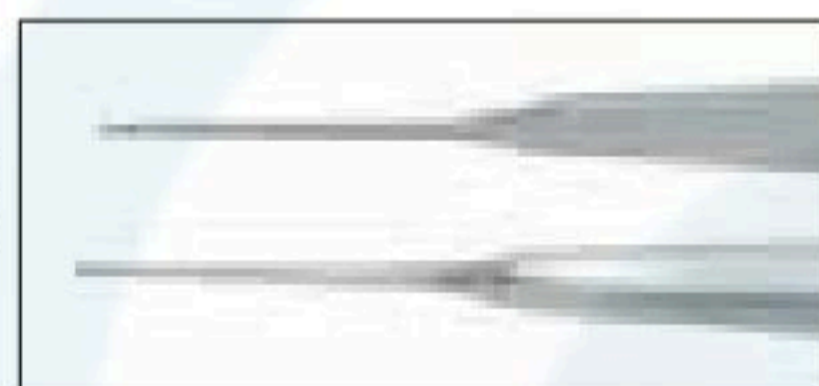
Vessel Dilator

- 13.5cm/4³/₈" length
- Curved tips 0.2mm Ø

HFSGT - 3d.2

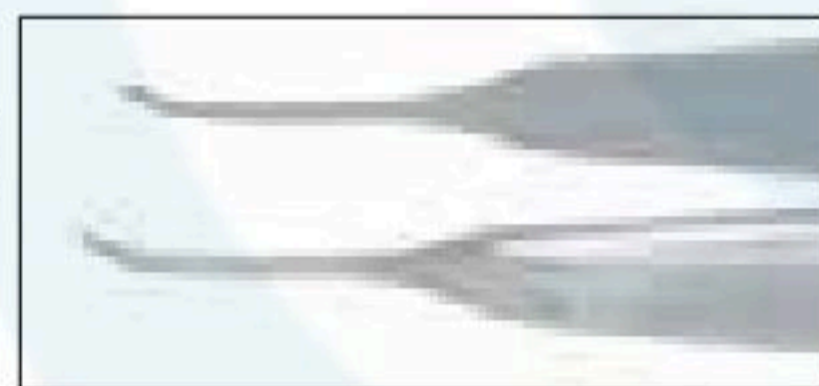
Vessel Dilator

- 13.5cm/4³/₈" length
- Curved tips 0.2mm Ø

HFCLGT - 3d.2

Vessel Dilator Long

- 18cm/7" length
- Tips 0.3mm Ø

HFGT - 18d.3

Vessel Dilator Long

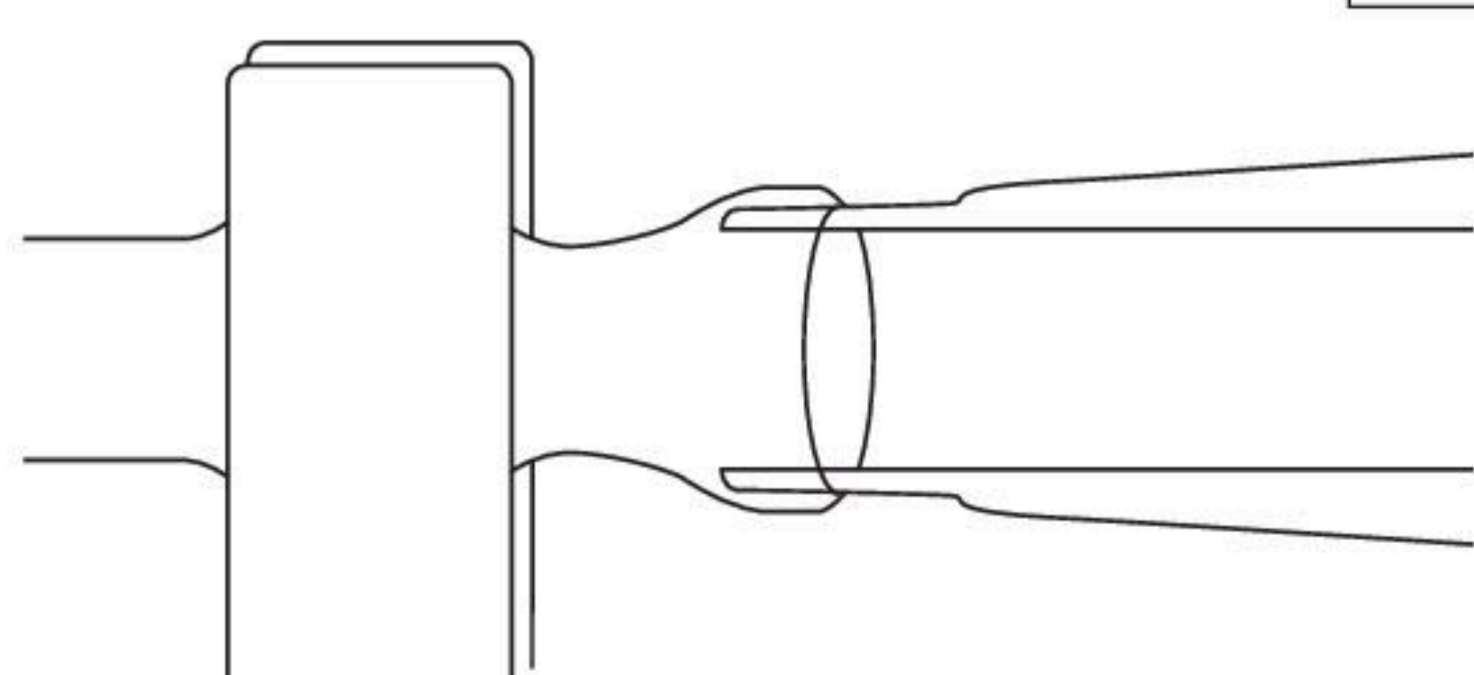
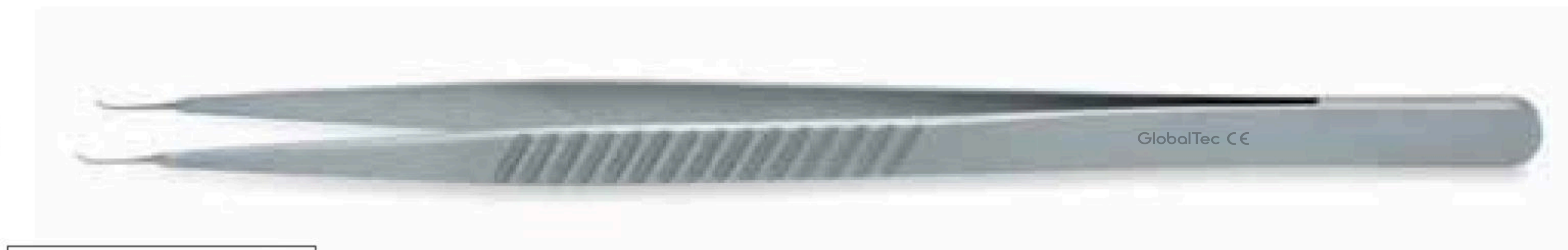
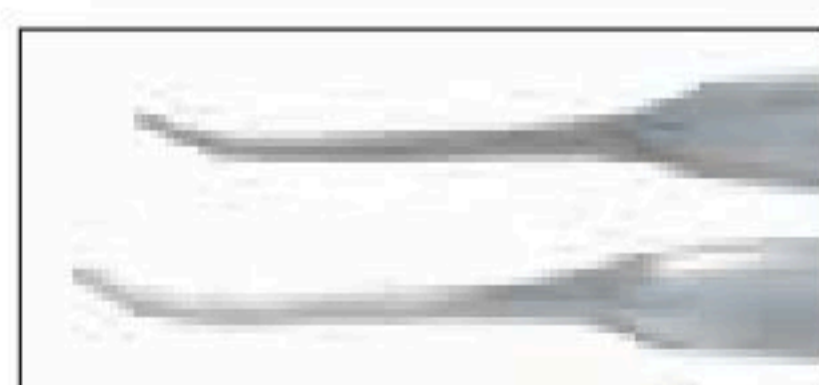
- 18cm/7" length
- Curved tips 0.2mm Ø

HFCLGT - 18d.2

GT Vessel Dilators have Mirror polished parallel tips for interluminal vessel dilation. The entire area is opened to the same diameter and the pressure is distributed evenly. This ensures that unnecessary damage to the vessel is avoided.

MICRO SURGERY INSTRUMENTS

Round Bodied Vessel Dilator

- 15cm/6" length
- Straight tips 0.3mm Ø
- Balanced forceps



HFSGT 15 RM-8d.3

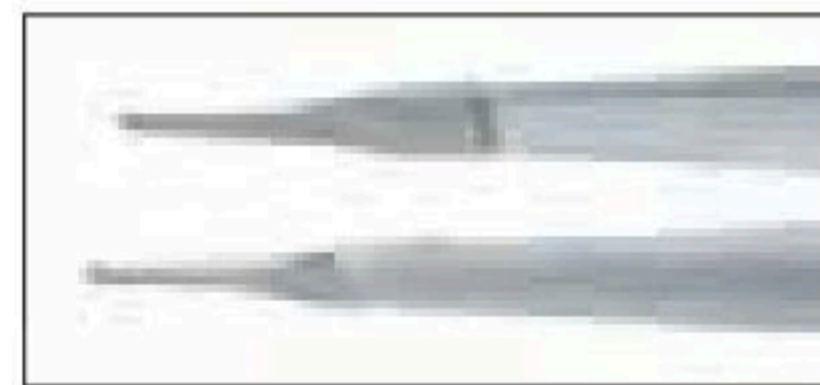

Round Bodied Vessel Dilator

- 11cm/4¼" length
- Tips 0.3mm Ø

HFCGT 15 RM-8d.2

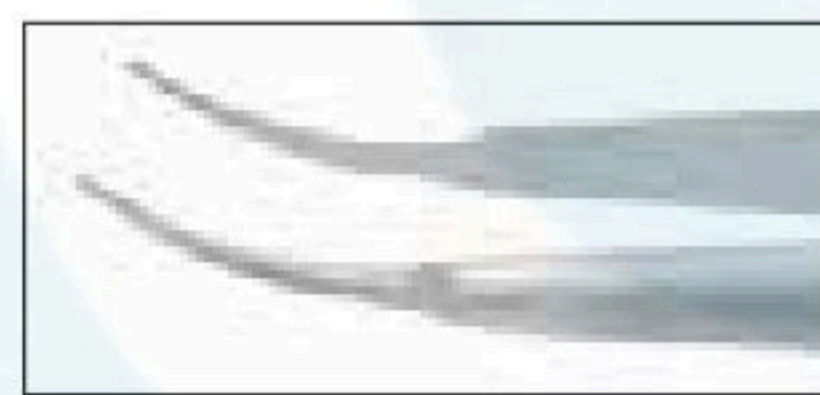

Round Bodied Vessel Dilator

- 18cm/7" length
- Straight tips 0.3mm Ø
- Balanced forceps

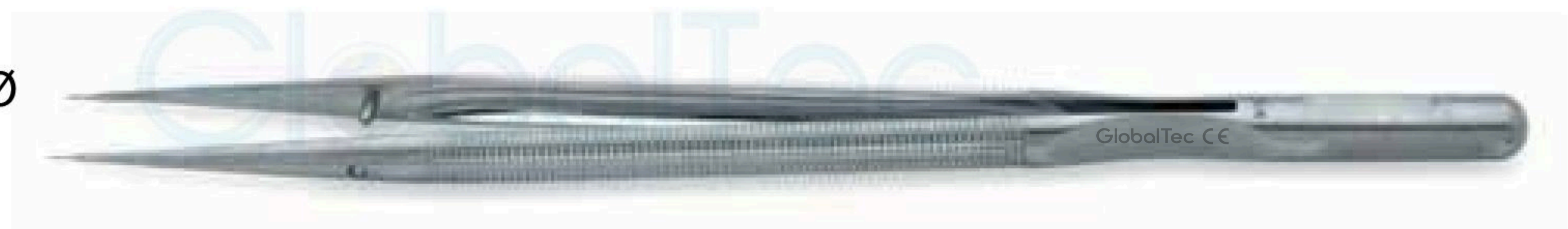

HFSGT 18 RM-8d.3



Round Bodied Vessel Dilator

- 18cm/7" length
- Curved tips 0.3mm Ø
- Balanced forceps

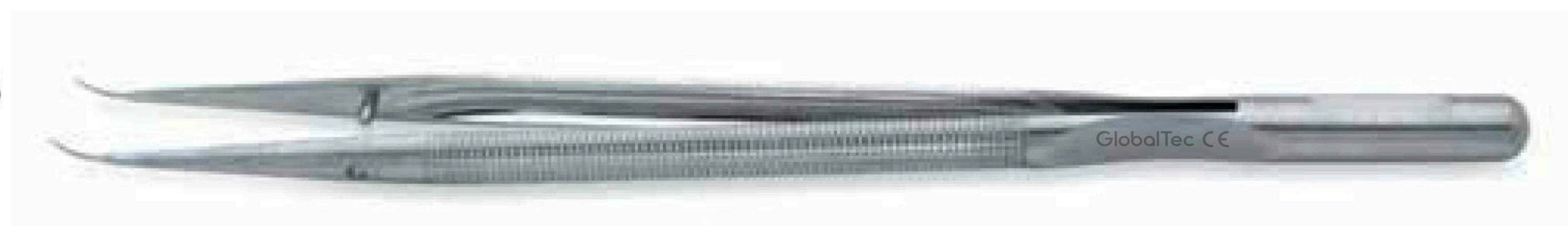

HFCGT 18 RM-8d.3

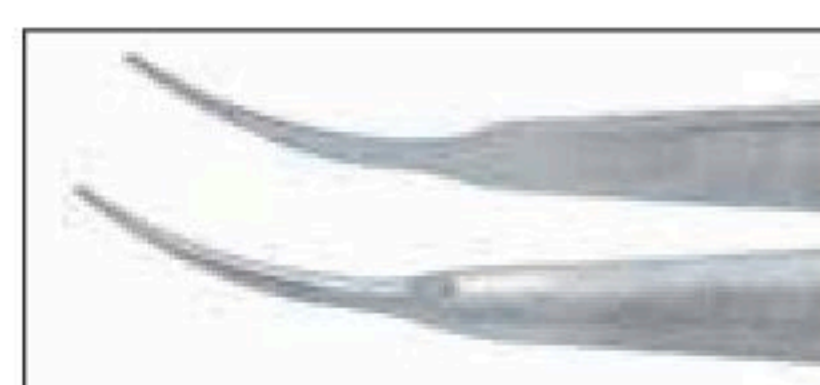

HAND & FOOT SURGERY
MICRO SURGERY INSTRUMENTS
Jewellers Forceps

- 11cm/4¼" length
- Tips 0.3mm

HFGT- 5

Jewellers Forceps Long

- 15cm/6" length
- Tips 0.3mm

HFLGT- 5

Jewellers Forceps

- 12cm/4¾" length
- Tips 0.3mm

HFGT- 3

Jewellers Forceps

- 13.5cm/5⅜" length
- Tips 0.3mm

HFLGT- 3

Pierse Forceps

- 12cm/4¾" length
- Tips 0.3mm

HFPGT- 3

Pierse Forceps have a micro hole in the tips which securely grip tissue with minimal trauma

Micro Adson Fixation Forceps

- 12cm/4¾" length
- 1x2microteeth
- Tips 0.3mm

HFGT- 1

MICRO SURGERY INSTRUMENTS

Round Bodied Forceps

- 15cm/6" length
- Straight, with platform
- Tips 0.3mm Ø
- Balanced forceps

HFSGT 15 RM8



Round Bodied Forceps

- 15cm/6" length
- Straight, with platform
- Tips 0.3mm Ø
- Balanced forceps

HFCGT 15 RM8



Round Bodied Angled Forceps

- 15cm/6" length
- Angled tips 0.2mm Ø
- Balanced forceps

HFASGT 15 RM8

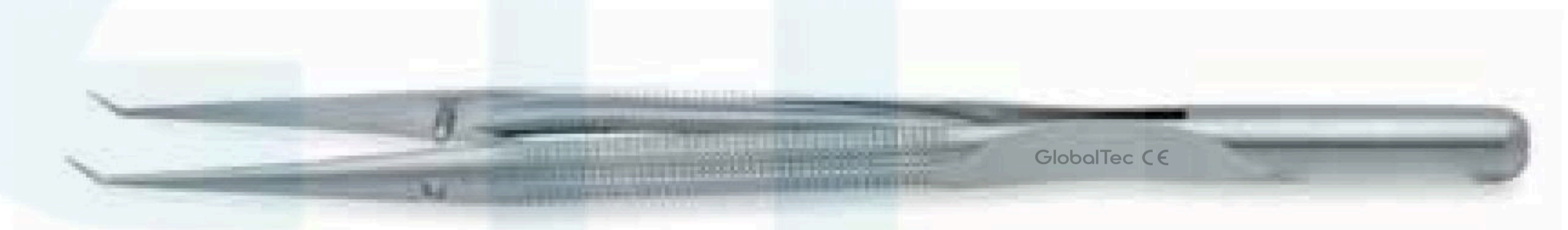

Round Bodied Forceps

- 13.5cm/5³/₈" length
- Tips 0.3mm

HFSGT 15 RM8

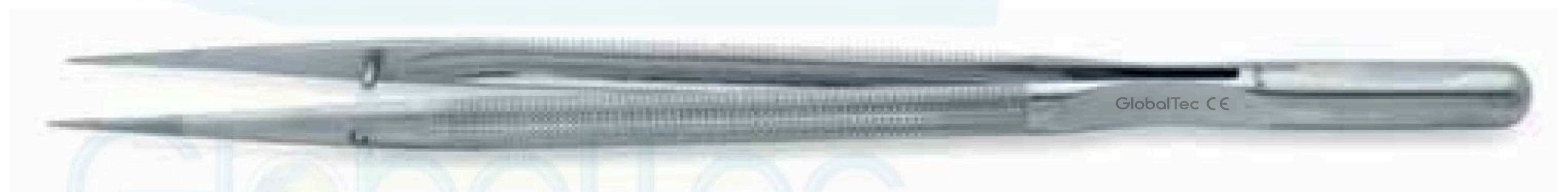

Round Bodied Forceps

- 15cm/6" length
- Straight, with platform
- Tips 0.3mm Ø
- Balanced forceps

HFCGT 18 RM8



Round Bodied Angled Forceps

- 18cm/7" length
- Angled tips 0.2mm Ø
- Balanced forceps

HFSGT 18 RM8



HAND & FOOT SURGERY
MICRO SURGERY INSTRUMENTS

Straight Scissors Flat Handle

- 15cm/6" length
- Blades 19mm long



HFSGT-15

Adventitia Scissors with pointed tips

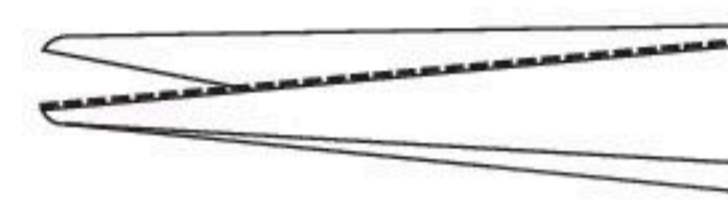
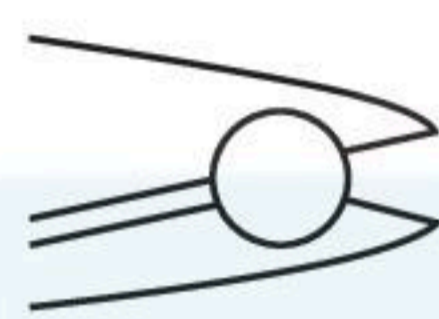

SAS -15T

Available with Micro Serrations for nerve cutting -straight

Curved Scissors Flat Handle

- 15cm/6" length
- Blades 19mm long



HFCGT-15

Dissecting Scissors with rounded tips

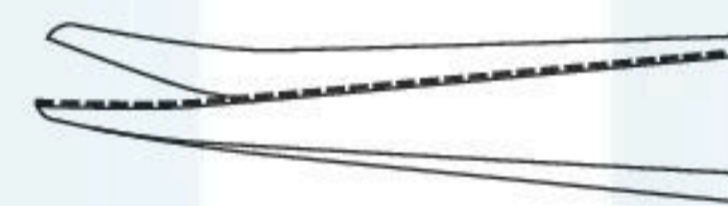
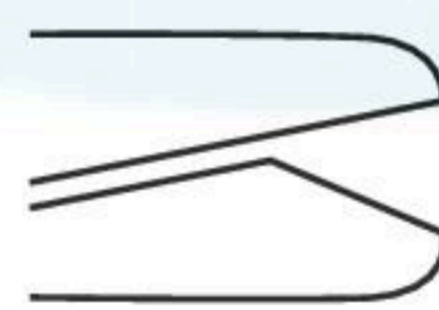

SDC -15T

Available with Micro Serrations for nerve cutting -Curved

Straight Scissors Flat Handle

- 15cm/6" length
- Blades 15mm long



HFSGT-155

Adventitia Scissors with pointed tips

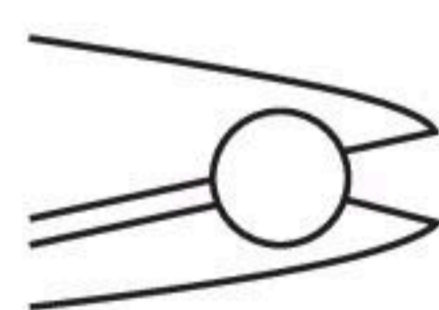

Curved Scissors Flat Handle

- 15cm/6" length
- Blades 15mm long



HFCGT-155

Dissecting Scissors with rounded tips

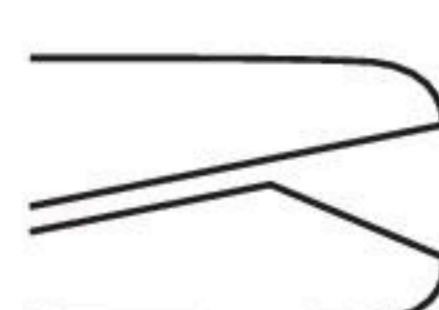

MICRO SURGERY INSTRUMENTS

Straight Scissors Round Handle

- 15cm/6" **SASGT 15 R8**
- Blades 12mm long
- 18cm/7" **SASGT 18 R8**
- Blades 14mm long

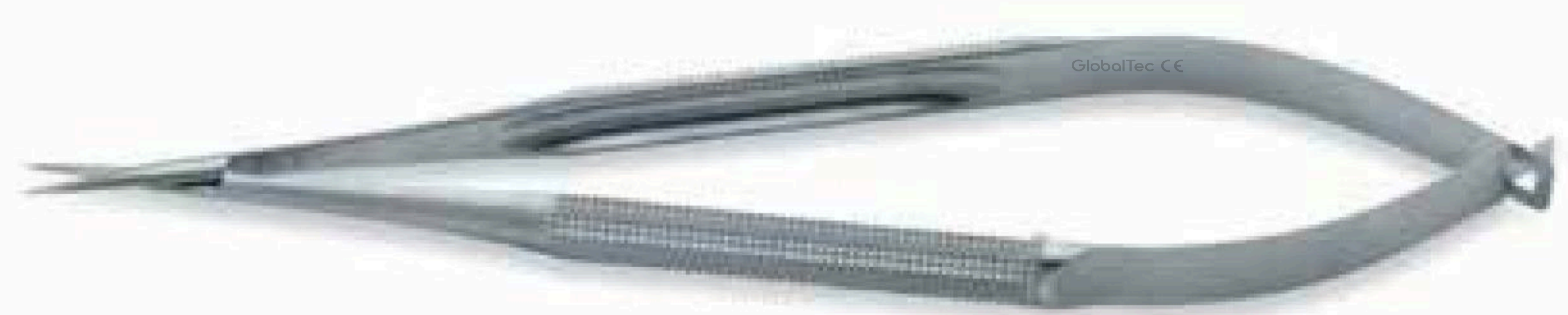

Adventitia Scissors with pointed tips

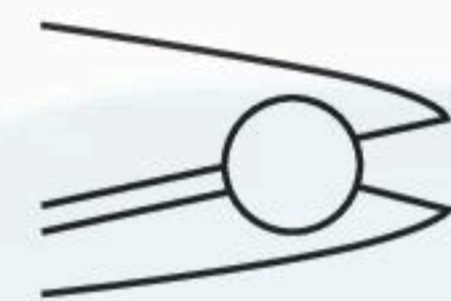

Curved Scissors Round Handle

- 15cm/6" **HFCGT 15 R8**
- Blades 12mm long



- 18cm/7" **HFCGT 18 R8**

Dissecting Scissors with rounded tips

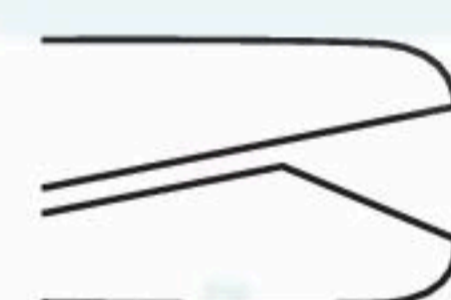

Blondeel Scissors Round Handle

- Blades 15mm long
- Curved blades

- 15cm/6" **HFCGT 15R-8-2R**

- 18cm/7" **HFCTGT 18R-8-2R**



These Scissors were designed by professor Phillip Blondeel for use in breast reconstruction utilising a perforator flap. A combination of ring handle design for preparation of fine structures, the round handle micro instrument handle allows the user to perform fine micro surgery.

MICRO SURGERY INSTRUMENTS

Double Action Micro Needle Holder

Round bodied
0.4mm jaws



Without Lock	Straight	Curved
13cm/5"	BS-13-8	B-13-8
15cm/6"	BS-15-8	B-15-8
18cm/7"	BS-18-8	B-15-8

Double Action Micro Needle Holder

Flat handled
0.4mm jaws



Without Lock	Curved
14cm/5½"	C-14
18cm/7"	C-18

Double Action Micro Needle Holder

Round bodied
0.4mm jaws



Without Lock	Curved
15cm/6"	NH-15 RM-8
18cm/7"	NH-18 RM-8

HAND & FOOT SURGERY

ACLAND MICRO VESSEL CLAMPS

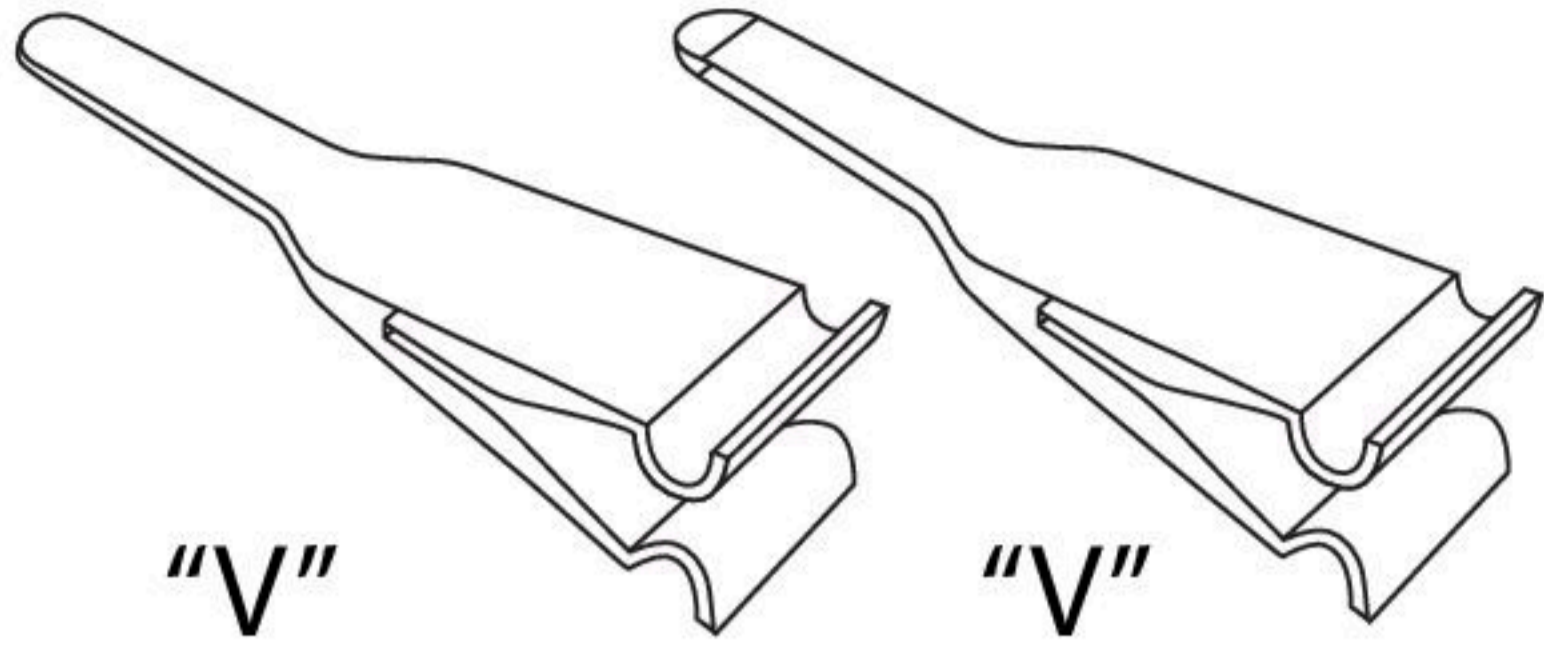

- Light and compact design
- Extremely durable
- A unique gripping surface
- Smooth sliding bar action
- on all approximator clamps
- Clamp profile with parallel sided jaws
- Matt or black finish

"A" or "V" Pattern?

Throughout the series, the "V" pattern is the all-purpose clamp, commonly used on all veins, and almost all arteries. The "A" pattern, available in all sizes, is designed for exceptionally thick-walled vessels and slippery arteries. The slight incurve of the tips of the "A" pattern jaw provides extra security against slippage.



Acland Clamp Container

HF4400 - 00



Double Clamps

Single Clamps

Ordering details

SINGLE CLAMPS		DOUBLE APPROXIMATING CLAMPS		DOUBLE CLAMPS WITH FRAME	
00396 V 00397 A	CLAMP SIZE B - 1 0.4 - 1.0mm	00414 V 00415 A	CLAMP SIZE ABB - 11 0.4 - 1.0mm	00408 V 00409 A	CLAMP SIZE ABB - 1 0.4 - 1.0mm
00398 V 00399 A	CLAMP SIZE B - 1 0.6 - 1.5mm	00416 V 00417 A	ABB - 22 0.6 - 1.5mm	00410 V 00411 A	CLAMP SIZE 0.6 - 1.5mm
00400 V 00401 A	CLAMP SIZE 1.0 - 2.25mm	00418 V 00419 A	ABB - 33 1.0 - 2.25mm	00412 V 00413 A	ABB - 3 1.0 - 2.25mm
00325	CLAMP SIZE 1.5 - 3.5mm	00326	HD - D 1.5 - 3.5mm	Clamp Box CB-1	
00286	RD - S 2.0 - 5.0mm	00287	RD - D 2.0 - 5.0mm	Clamp Applicator CAF-4	

HAND & FOOT SURGERY

MICRO SURGERY CLAMPS

- Sterile, single use, disposable
- Atraumatic jaws
- Colour coded for better differentiation
- Consistent and reliable closing pressure
- Designed for use on veins and arteries
- Light weight
- Blue, black and purple finish provides excellent contrast in the field
- Radiopaque
- Eliminates cleaning and processing problems
- Economical

Single Clamps
packed in boxes of 24



P - 1
0.4 - 1mm
Vessels

HF70005



P - 2
0.6 - 1.5mm
Vessels

HF70003



P - 3
1.0 - 2.5mm
Vessels

HF70007

Double Clamps
packed in boxes of 12



APP - 11
0.4 - 1mm
Vessels

HF70006



APP - 22
0.6 - 1.5mm
Vessels

HF70004



APP - 33
1.0 - 2.5mm
Vessels

HF70008

VISIBILITY BACKGROUND MATERIAL

TO ASSIST IN VISUALISING MICRO VESSELS DURING SURGERY

Application: For use in Micro Surgical Anastomosis of Micro Vessels under a Microscope to allow the surgeon to better visualize the detail of the vessels, being closed.

The Visibility Material can be used either with the Grid side up to give the Surgeon a scale of the vessel alternatively the reverse Plain side can also be used.

The material has a none reflective surface eliminating distractions from theatre lighting and has a non-tacky finish to aid mobilization of the Vessel.



1mm Grid one side & matt finish
on reverse. Size: 50mm x 25mm

Ordering details:

COLOUR	Ordering code
Yellow	VB2
Green	VB3
Blue	VB4

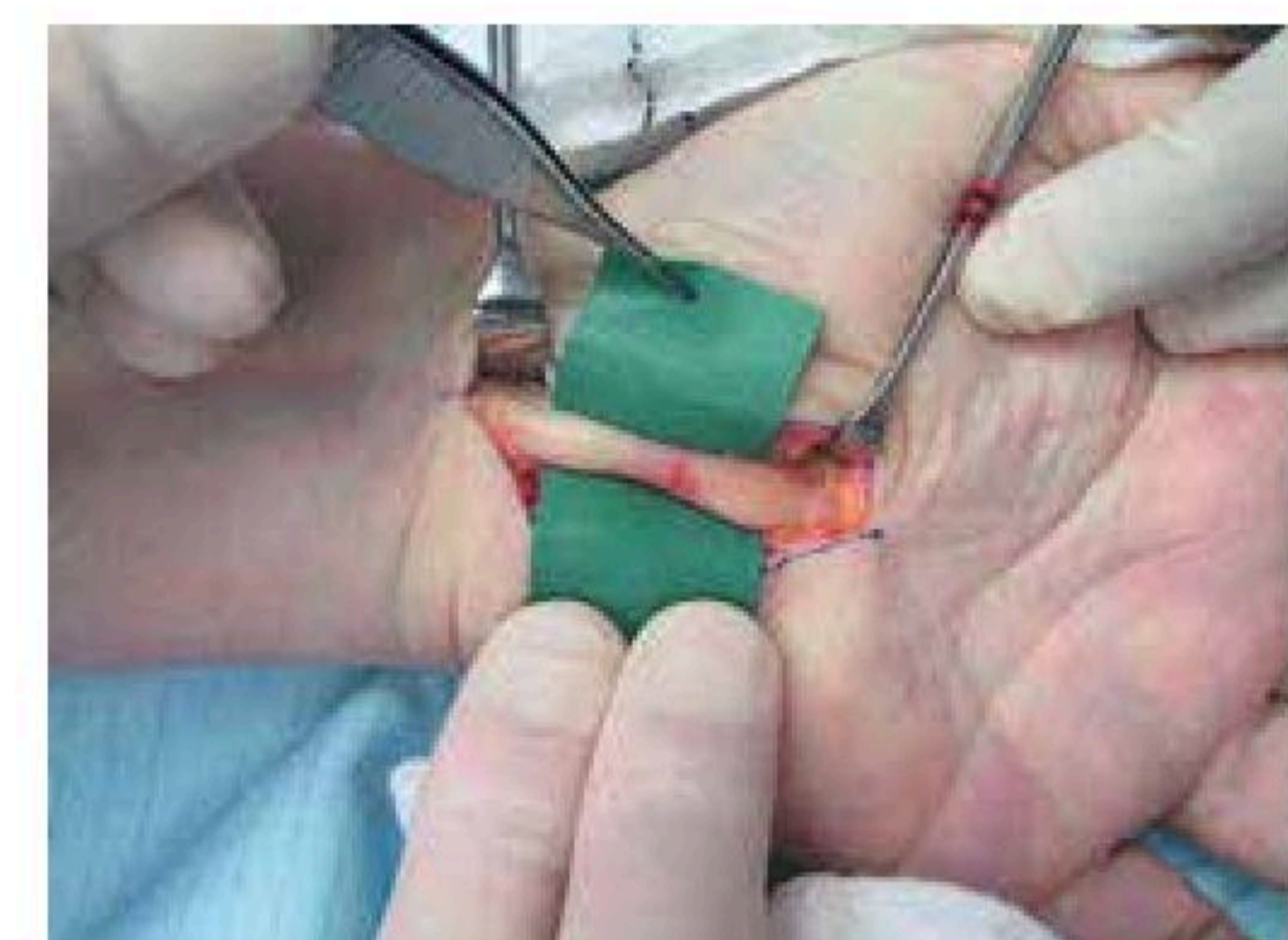
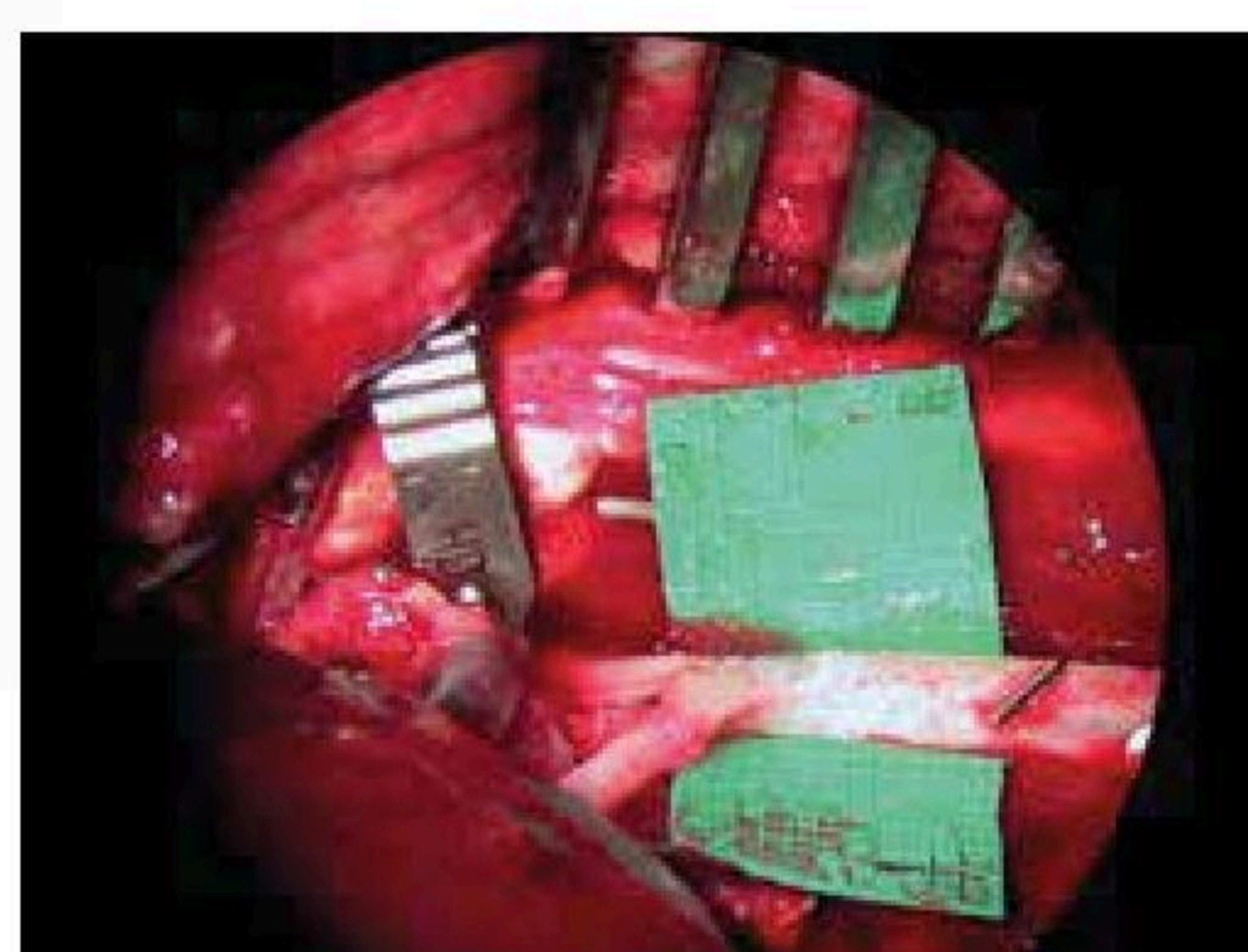

X-Ray opaque silicon material

1mm Grid for accurate measurement of vessels

Latex Free material

Sterile Packed in boxes of 12 pieces

HAND & FOOT SURGERY
MICRO INSTRUMENT SETS

Globaltec offer both a basic Micro Surgery Instrument Set, equipping the surgeon with the basic Instruments for most micro surgery procedures and a reduced set suitable for Nerve and Tendon Repair.

Globaltec Basic Micro Instrument Set
BMS -1

Set consisting of the following instruments:



Qty	Order Code	Description
1	E.4026/4	Micro Instrument Container
1	SAS-15R8	Micro Scissors R/B 15cm Straight
1	SDC-15R8	Micro Scissors R/B 15cm Curved
1	BS-15-8	Micro Needle Holder R/B 15cm Straight
1	B-15-8	Micro Needle Holder R/B 15cm Straight
1	FRS-15 RM8	Suture Tying Forceps R/B 15cm Straight
1	FRC-15 RM8	Suture Tying Forceps R/B 15cm Curved
2	JF-5	Jewellers Forceps No.5 11cm
1	D5a	Micro Vessel Dilator 11cm
1	CAF-4	Clamp Applying Forceps - No Lock
1	CB -1	Clamp Box
1pr	00398V	Single Acland Clamps B - 2V
1pr	00400V	Single Acland Clamps B - 3V
1pr	00325V	Single Acland Clamps HD - S

Micro Instrument Set for Nerve Repair Surgery
MNS -1

Set consisting of the following instruments:



Qty	Order Code	Description
1	E.4026/1	Micro Instrument Container
1	B-15-8	Micro Needle Holder R/B 15cm Curved
1	SAS -15T	Micro Scissors Flat Handled 15cm Straight Serrated Blade
1	JF-5	Jewellers Forceps No.5 11cm

INSTRUMENT CONTAINERS



SINGLE TRAY CONTAINERS

Internal Dimension			Code
A	B	C	
200 x 140 x 50mm			E 4026/1
280 x 195 x 50mm			E 4026/4
265 x 255 x 50mm			E 4026/5
380 x 260 x 50mm			E 4026/7

E 4026/5

Standard Container illustrated

One of our popular cases for Micro Instruments

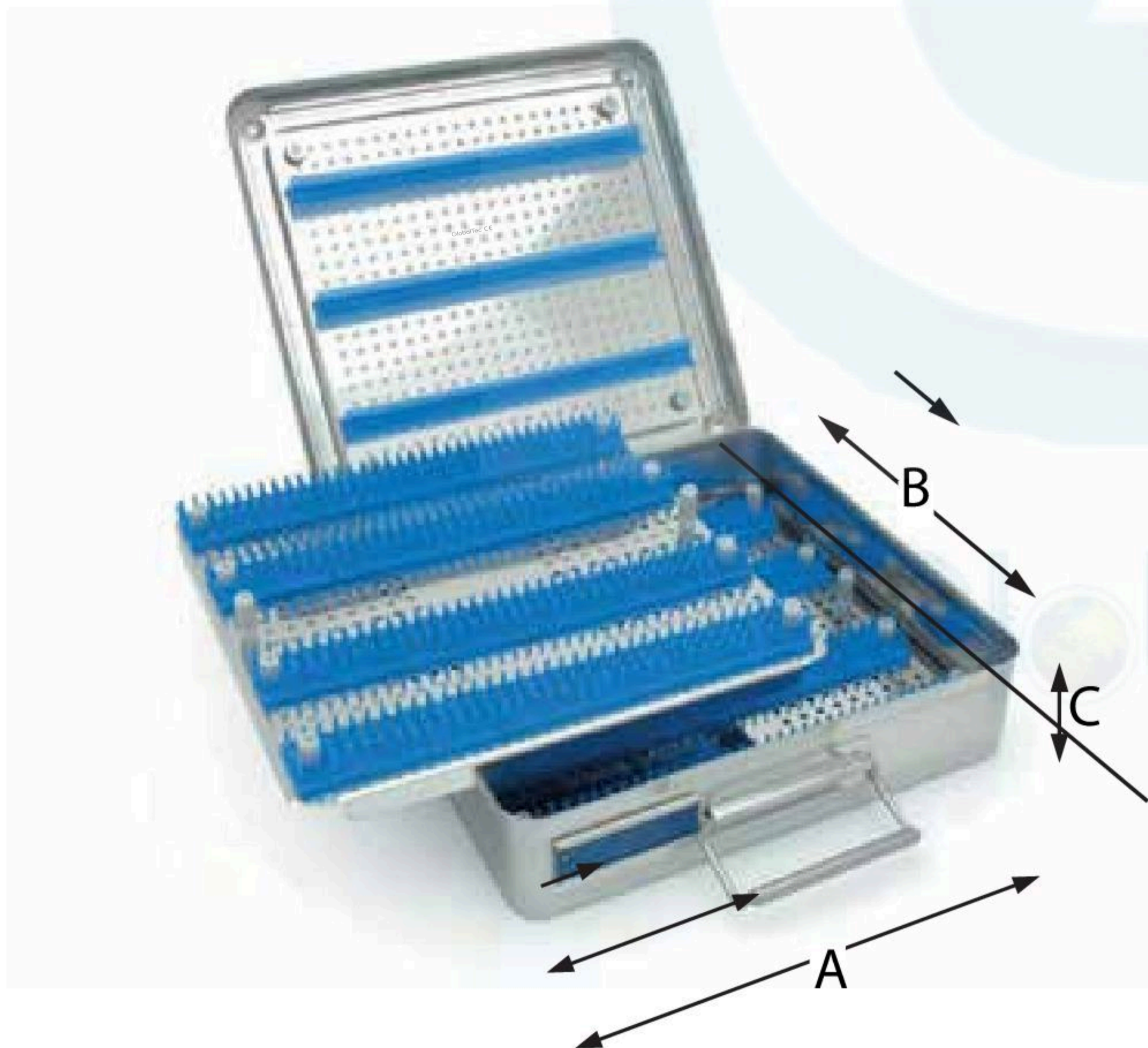

DOUBLE TRAY CONTAINERS

Internal Dimension			Code
A	B	C	
280 x 195 x 65mm			E 4026/4 D
265 x 255 x 65mm			E 4026/5 D
380 x 260 x 65mm			E 4026/7 D

E 4026/5D

Double Tray Container illustrated

Two removable perforated trays



Acland Clamp Container

HF4400 - 00

With individual compartments for various clamp sizes

Great Creations Comes From The Sincerity

WHO WE ARE

GlobalTec Surgical Instruments is a trusted provider of high-quality specialty surgical instruments. With deep industry expertise, our specialists ensure precision, reliability, and 100% customer satisfaction.

We deliver unmatched value with a surgeon satisfaction guarantee, offering instruments tailored to your exact specifications. With 99% customer satisfaction, we ensure superior quality and performance in every product.

Our strength lies in our skilled professionals and commitment to excellence, providing only the best instruments that meet the highest industry standards.



Our Other Products :

Cardiac Surgery • Endoscopic Surgery • Gynecology Surgery • General Surgery
Hand Surgery • Micro Surgery • Plastic Surgery
Angioplasty Surgery • Spine Surgery

★ **CDSCO Reg No: Global-thris-KL/M/MD/019721** ★



+91 7994555004
Office +91 04802733660
sales@globaltecsurgical.com

DOOR No. 17/240, MELOOR P O, CHALAKUDY, THRISSUR, KERALA - 680 311

Email: info@globaltecsurgical.com, sales@globaltecsurgical.com, customercare@globaltecsurgical.com,

Website: www.globaltecsurgical.com. Phone: +91 0480 2733660 Mob: +91 7994555004

Thank you



DOOR No. 17/240, MELOOR P O, CHALAKUDY, THRISSUR, KERALA – 680 311

Email : info@globaltecsurgical.com, sales@globaltecsurgical.com, customercare@globaltecsurgical.com

Website: www.globaltecsurgical.com | Phone : +91 0480 2733660 | Mob : +91 7994555004