



# GlobalTec

Surgical Instruments

CDSCO Reg No : Globel-thris-KL/M/MD/019721



# SPINAL SURGERY

INSTRUMENTS



## Introduction

GlobalTec Surgical is a highly experienced manufacturer of surgical instruments. With our wide range of products, we provide instruments for surgeries from head to toe.

We present our catalogue detailing our range of instruments specialising in orthopaedic surgery.

Our specialist instruments are manufactured to the highest possible standards using the most modern processes and technology. Based in Thrissur, the cultural capital of Kerala - "God's Own Country" - we leverage technological advancements to deliver world-class surgical solutions.



*The*  
EXCELLENCE  
*Along* EXPERIENCE



+91 7994555004  
Office +91 04802733660  
sales@globaltecsurgicals.com

DOOR No. 17/240, MELOOR P O, CHALAKUDY, THRISSUR, KERALA - 680 311

Email: info@globaltecsurgicals.com, sales@globaltecsurgicals.com, customercare@globaltecsurgicals.com,

Website: www.globaltecsurgicals.com. Phone: +91 0480 2733660 Mob: +91 7994555004

# SPINAL SURGERY

## INDEX

<b>LAMINECTOMY PUNCHES</b>		Page No		Page No.
90° Kerrison Laminectomy Punch	1		Stille-Liston Bone Cutters	19
'Black Line' Kerrison Punch	2		Liston-Key-Horsley Bone Cutters	19
Bone Ejector Kerrison Punch	2		Tudor Edwards/Vehmehren Costotome	19
Thin Footplate Kerrison Punch	3			
Wide Opening Kerrison Punch	3		<b>OSTEOTOMES &amp; MALLETS</b>	
'Clean Wave' Laminectomy Punch	4		Dahmen Osteotome	20
Love Kerrison Punch	4		Lexer Osteotome	20
Long Anterior Kerrison Punch	5		Stille Osteotome	20
Curved Foramenotomy Punch	5		Scaglietti Osteotome Set	21
Ferris-Smith Kerrison Punch	6		Mallets	21 & 22
Osteo-Rotating Punch	6			Page No.
			<b>ELEVATORS, GOUGES &amp; IMPACTORS</b>	
<b>DISC RONGEURS</b>			Adson Elevator	23
Intervertebral Disc Rongeur	7		Pennybacker Elevator	23
Caspar Disc Rongeur	8		Bone Raspatory	23
Schlesinger Toothed Rongeur	8		Farabeuf Elevator	23
Williams Disc Rongeur	9		Trethowan Lever	24
'Pea Pod' Disc Rongeur	9		Lanes Lever	24
Beck Disc Rongeur	9		Fagge Lever	24
Munich Grasping Forceps	10		Bristows Elevator	24
Decker Rongeur	10		Hohmanns Lever	25
Nicola Biopsy Forceps	10		Inferior Hohmann Hip Retractor	25
'Clean Wave' Intervertebral Rongeur	11		Zielke Gouge	25
Ferris-Smith Rongeur	12		Capener Gouge	25
Anterior Disc Rongeur	12		Cervical Impactor	26
Anterior Long Rongeur	12		Lumbar Impactor	26
			Anterior Impactor	26
<b>BONE NIBBLERS &amp; CUTTERS</b>			Cobb Elevators	27 & 28
Lempert Bone Nibbler	13		<b>SPINAL CURETTES</b>	
Luer Bone Nibbler	13		Bayonet Cervical Micro Curette Set	29
Adsons Bone Nibbler	13		Karlin Style Bayonet Cervical Micro Curettes	30
Pennybacker Bone Nibbler	14		Lempert Curette	31
Northfields Bone Nibbler	14		Bruns Curette	31
'Rat Toothed' Bone Nibbler	14		Tufnol Handle Curette	31
Zielke Rongeur	15		Double Handled Curette	32
Matzen Rongeur	15		Comfort Handle Curette	32
Beyer Bone Nibbler	15		Long Anterior Curette	32
Jansen Bone Nibbler	16		Light-Grip Cervical Curette	33
Marquardt Bone Nibbler	16		Light-Grip Lumbar Curette	34
Smith-Peterson Bone Nibbler	16		Cones Curette	35
Stille-Luer Bone Nibbler	17		Zielke Curette	35
Leksell Bone Nibbler	17		Volkman Curette	35
Echlin Duckbill Nibbler	18			
Long Anterior Leksell Bone Nibbler	18			
Sypert Bone Nibbler	18			
McIndoe Bone Cutters	19			

# SPINAL SURGERY

## INDEX

<b>DISSECTORS</b>	Page No	Page No	
Swedish Dissector	36	Wests/Weitlaner S/R Retractor	47
Howarth Elevator	36	Travers S/R Retractor	47
MacDonald Elevator/Dissector	36	Norfolk & Norwich S/R Retractor	47
Watson Cheyne Dissector	36	Cones S/R Retractor	48
Freers Elevator/Dissector	36	Beckman-Adson S/R Retractor	48
<b>CASPAR CERVICAL DISTRACTION SET</b>		Gelpi Laminectomy S/R Retractor	49
Caspar Distraction Set	37 & 38	Hardman S/R Retractor	49
<b>LAMINA SPREADERS</b>		Meyerding S/R Retractor	49
Cervical Vertebral Spreader	39	Long Gelpi Orthopaedic S/R Retractor	50
Cloward Cervical Spreader	39	Viper Scoliosis S/R Retractor	50
Cloward Lamina Spreader	39	Micro Discectomy Retractor System	51 & 52
Baby Inge Lamina Spreader	40	Micro Discectomy Instrument Set	53 & 54
Inge Lamina Spreader	40	Black Belt Cervical Retractor System	55 & 56
Scaglietti Lamina Spreader	40	Super-Slide Laminectomy Retractor System	57 & 58
Long Anterior Lamina Spreader	40	Caspar Retractor System	59 & 60
<b>HOOKS &amp; PROBES</b>		Black Belt Micro Discectomy Retractor Set	61
Adson Dural Hook	41	<b>BAYONET MICRO INSTRUMENTS FOR DURAL REPAIRS</b>	
Titanium Micro Hook	41	Yasargil Bayonet Micro Needle Holder	62
Crile Hook	41	Bayonet Micro Needle Holder	62
Emmet Hook	41	Yasargil Bayonet Micro Forceps	62
Cushing Hook	41	Yasargil Bayonet Micro Scissors	62
Adson Hook	42	<b>BIPOLAR FORCEPS</b>	
McCulloch Style Probe	42	Straight Bipolar Forceps	63
Manipulation Hook	42	Bayonet Bipolar Forceps	63 & 64
Blalock Blunt Hook	42	<b>MISC INSTRUMENTS</b>	
Caspar Exploration Probe	42	Slim Nose Wire Twisters	65
<b>RETRACTORS</b>		Orthopaedic Locking Pliers	65
Love Bayonet Nerve Root Retractor	43	Combined Wire Cutters & Pliers	65
Krayenbuhl Nerve Root Retractor	43	Bolt Cutters	66
O'Connell Nerve Root Retractor	43	Muller-Claus Wire Cutters	66
Love Nerve Root Retractor	43	Needle Nosed Locking Pliers	66
Shepperd Suction Nerve Root Retractor	44	Measuring Caliper/Gauges	67
Nerve Root Retractor with Suction	44	Suction Tubes	68
Hess Nerve Root Retractor	44	Bayonet Forceps	68
Meyerding Retractor	45	Finochietto Spine Retractor	69
Langenbeck Retractor	45	Dr Remani Micro Dissectomy Retractor	69
Taylor Retractor	45	Mayfield Skull Retractor System	70
Cloward Blade Retractor	45	Wilson Radiolusent Frame	71
Bone Hook	45	MIS Tublar Retractor System	71
Volkman Retractor	45	Leyla Self Retaining Retractor System	72
Baby Weitlaner S/R Retractor	46		
Mollison S/R Child Retractor	46		
Mollison S/R Adult Retractor	46		

**SPINAL SURGERY**
**LAMINECTOMY PUNCH**
**Kerrison Laminectomy Punch**

90° UPWARD Jaw angle



90° UPWARD JAW

18 cm/7" Shaft	20 cm/8" Shaft	Bite Size
PS GT 9071	PS GT 9081	1 mm
PS GT 9072	PS GT 9082	2 mm
PS GT 9073	PS GT 9083	3 mm
PS GT 9074	PS GT 9084	4 mm
PS GT 9075	PS GT 9085	5 mm
PS GT 9076	PS GT 9086	6 mm

PS GT 9071	PS GT 9081	1 mm
PS GT 9072	PS GT 9082	2 mm
PS GT 9073	PS GT 9083	3 mm
PS GT 9074	PS GT 9084	4 mm
PS GT 9075	PS GT 9085	5 mm
PS GT 9076	PS GT 9086	6 mm

 90°  
UPWARD

**Kerrison Laminectomy Punch**

90° DOWNWARD Jaw angle



90° DOWNWARD JAW

18 cm/7" Shaft	20 cm/8" Shaft	Bite Size
PS GT 9071	PS GT 9081	1 mm
PS GT 9072	PS GT 9082	2 mm
PS GT 9073	PS GT 9083	3 mm
PS GT 9074	PS GT 9084	4 mm
PS GT 9075	PS GT 9085	5 mm
PS GT 9076	PS GT 9086	6 mm

PS GT 9071	PS GT 9081	1 mm
PS GT 9072	PS GT 9082	2 mm
PS GT 9073	PS GT 9083	3 mm
PS GT 9074	PS GT 9084	4 mm
PS GT 9075	PS GT 9085	5 mm
PS GT 9076	PS GT 9086	6 mm

 90°  
DOWNWARD

SPINAL SURGERY

LAMINECTOMY PUNCH

“Black Line” Kerrison Laminectomy Punch

- 40° UPWARD Jaw angle
- With special Titanium coating on surface
- Bone ejector



40° UPWARD JAW

18 cm/7" Shaft    20 cm/8" Shaft    23 cm/9" Shaft    Bite Size

PS GT 4071 Ti	PS GT 4081 Ti	PS GT 4091 Ti	1 mm
PS GT 4072 ETi	PS GT 4082 ETi	PS GT 4092 ETi	2 mm
PS GT 4073 ETi	PS GT 4083 ETi	PS GT 4093 ETi	3 mm
PS GT 4074 ETi	PS GT 4084 ETi	PS GT 4094 ETi	4 mm
PS GT 4075 ETi	PS GT 4085 ETi	PS GT 4095 ETi	5 mm
PS GT 4076 ETi	PS GT 4086 ETi	PS GT 4096 ETi	6 mm

40°  
UPWARD



Kerrison Laminectomy Punch with Bone Ejector

- 40° UPWARD Jaw angle
- Bone ejector

40° UPWARD JAW

18 cm/7" Shaft    20 cm/8" Shaft    23 cm/9" Shaft    Bite Size

PS GT 4071 E	PS GT 4081 E	PS GT 4091 E	1 mm
PS GT 4072 E	PS GT 4082 E	PS GT 4092 E	2 mm
PS GT 4073 E	PS GT 4083 E	PS GT 4093 E	3 mm
PS GT 4074 E	PS GT 4084 E	PS GT 4094 E	4 mm
PS GT 4075 E	PS GT 4085 E	PS GT 4095 E	5 mm
PS GT 4076 E	PS GT 4086 E	PS GT 4096 E	6 mm

40°  
UPWARD

**SPINAL SURGERY**
**LAMINECTOMY PUNCH**
**Thin Footplate Kerrison Laminectomy Punch**

- 40° UPWARD Jaw angle
- Thin footplate for Cervical surgery

**40° UPWARD JAW**

18 cm/7" Shaft	20 cm/8" Shaft	Bite Size
PS GT 4072 T	FS GT 4082 T	2 mm
PS GT 4073 T	FS GT 4082 T	3 mm
PS GT 4074 T	FS GT 4084 T	4 mm
PS GT 4075 T	FS GT 4085 T	5 mm
PS GT 4076 T	FS GT 4086 T	6 mm

PS GT 4072 T	FS GT 4082 T	2 mm
PS GT 4073 T	FS GT 4082 T	3 mm
PS GT 4074 T	FS GT 4084 T	4 mm
PS GT 4075 T	FS GT 4085 T	5 mm
PS GT 4076 T	FS GT 4086 T	6 mm

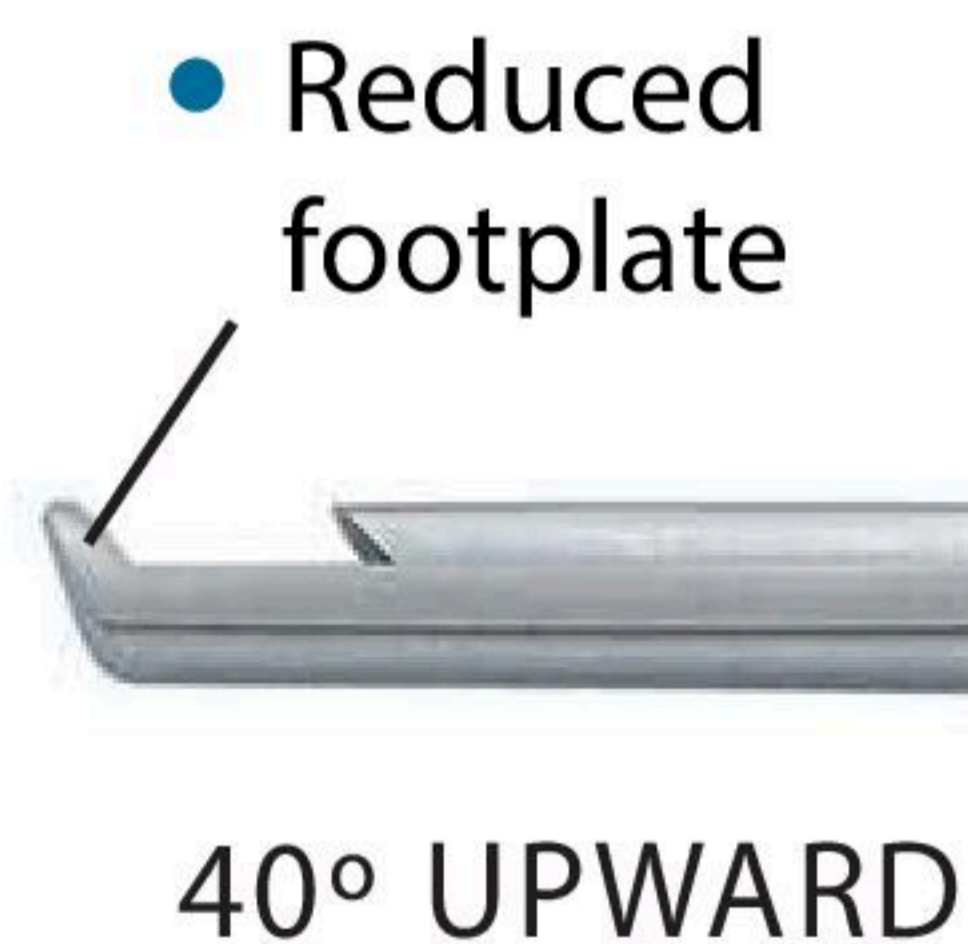

- A reduced footplate thickness useful for a restricted operating area

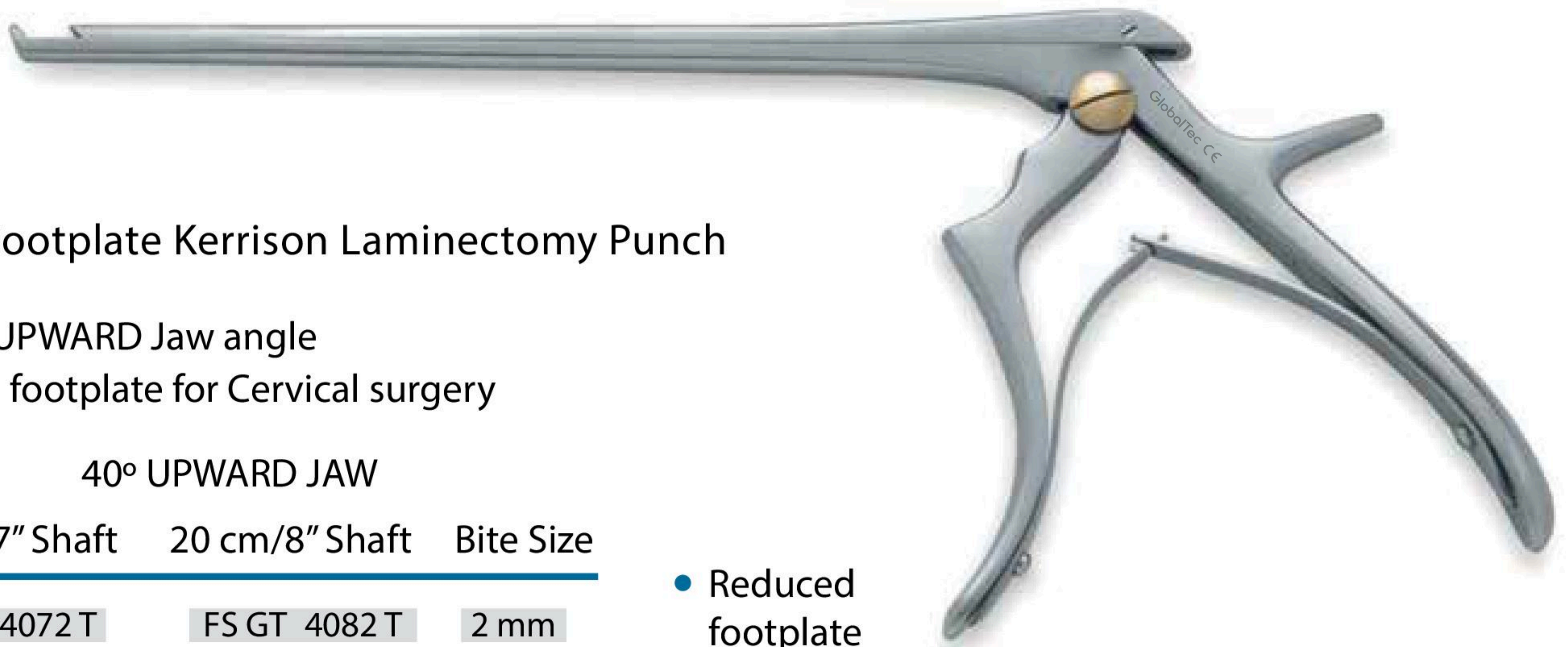
**Wide Opening Kerrison Laminectomy Punch**

- 40° UPWARD Jaw angle
- 16mm Wide opening jaw

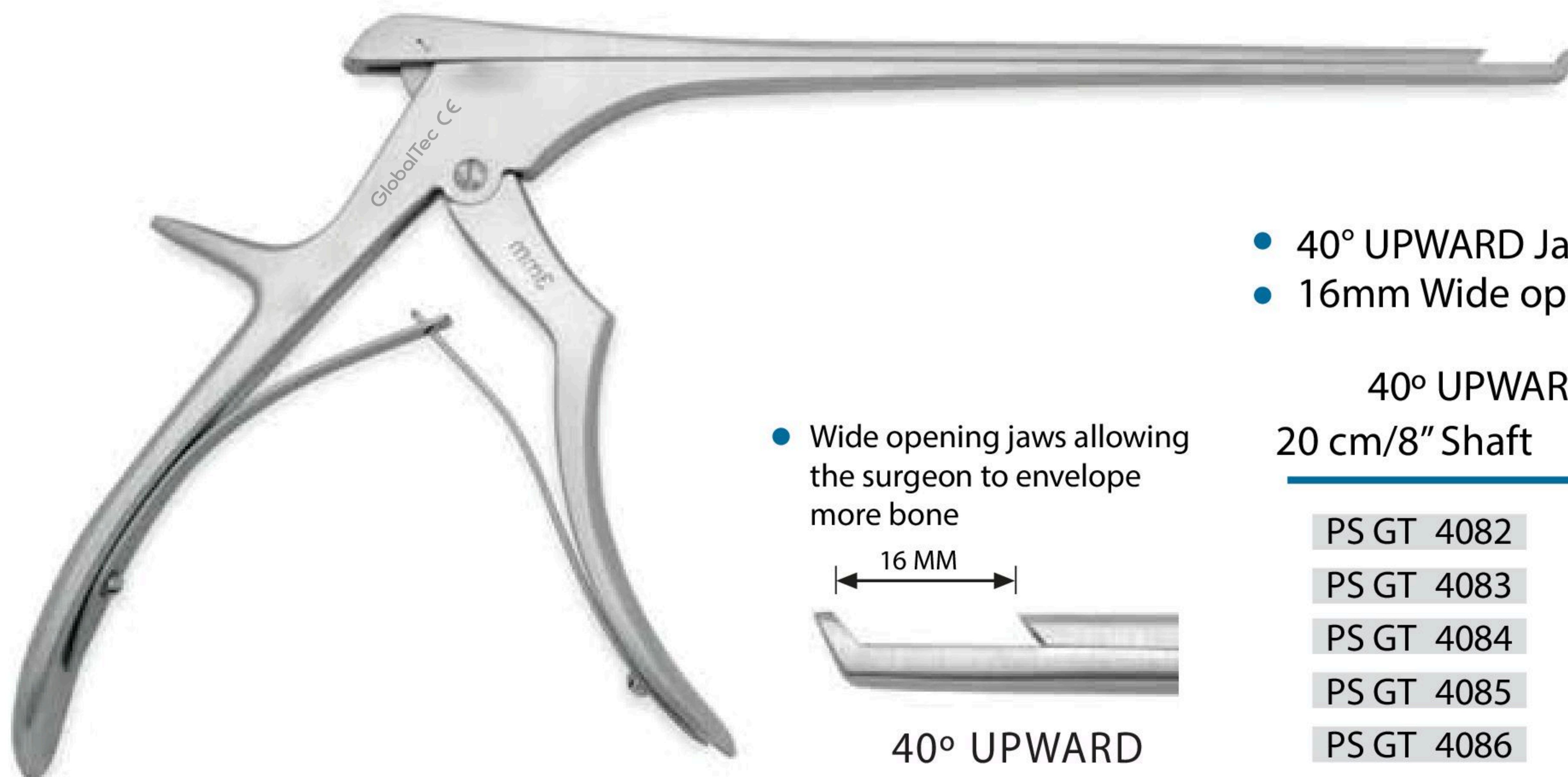

- Wide opening jaws allowing the surgeon to envelope more bone

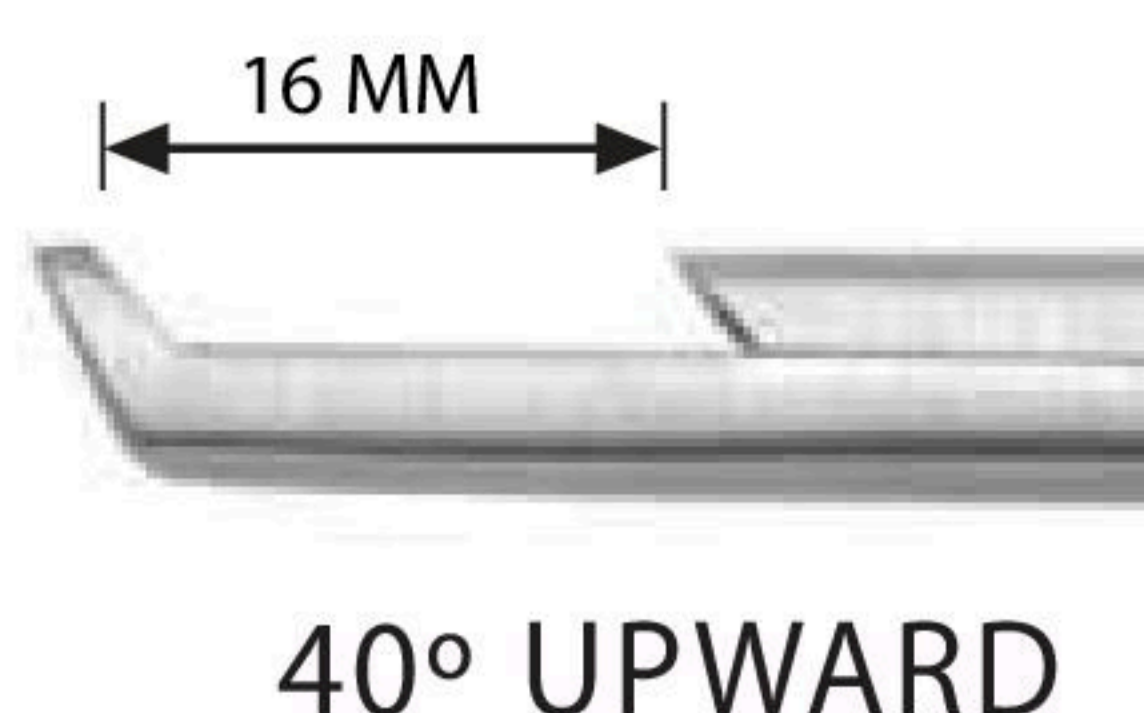

- 40° UPWARD Jaw angle
- 16mm Wide opening jaw

**40° UPWARD JAW**

20 cm/8" Shaft	Bite Size
PS GT 4082	2 mm
PS GT 4083	3 mm
PS GT 4084	4 mm
PS GT 4085	5 mm
PS GT 4086	6 mm

PS GT 4082	2 mm
PS GT 4083	3 mm
PS GT 4084	4 mm
PS GT 4085	5 mm
PS GT 4086	6 mm

SPINAL SURGERY

LAMINECTOMY PUNCH

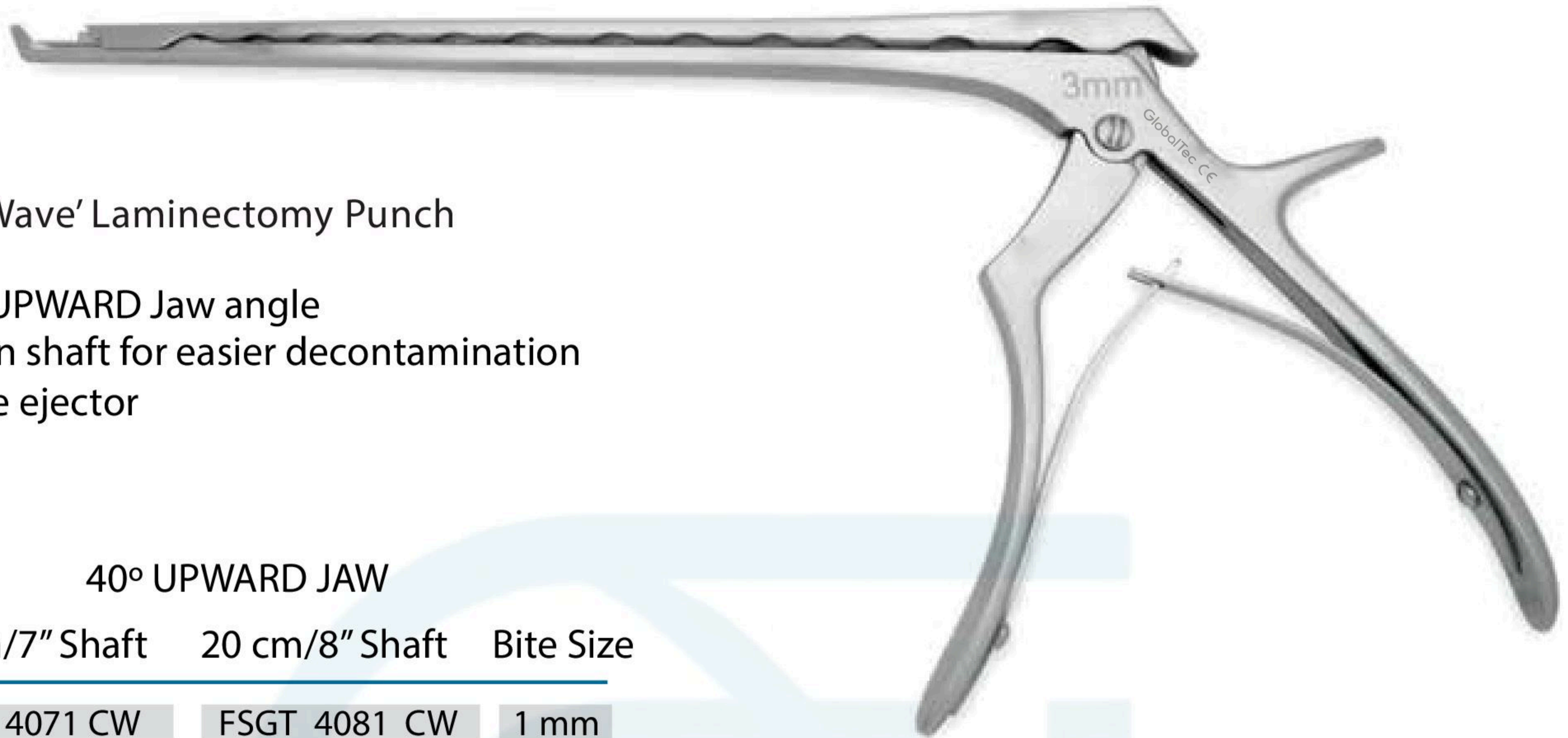

'Clean Wave' Laminectomy Punch

- 40° UPWARD Jaw angle
- Open shaft for easier decontamination
- Bone ejector

40° UPWARD JAW

18 cm/7" Shaft	20 cm/8" Shaft	Bite Size
PS GT 4071 CW	FSGT 4081 CW	1 mm
PS GT 4072 ECW	FS GT 4082 ECW	2 mm
PS GT 4073 ECW	FS GT 4083 ECW	3 mm
PS GT 4074 ECW	FS GT 4084 ECW	4 mm
PS GT 4075 ECW	FS GT 4085 ECW	5 mm
PS GT 4076 ECW	FS GT 4086 ECW	6 mm

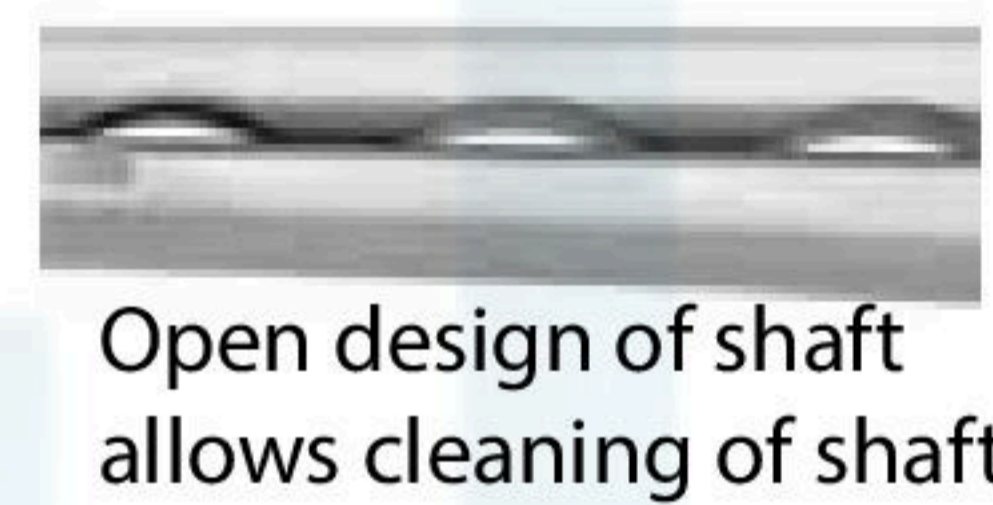

Bone ejector

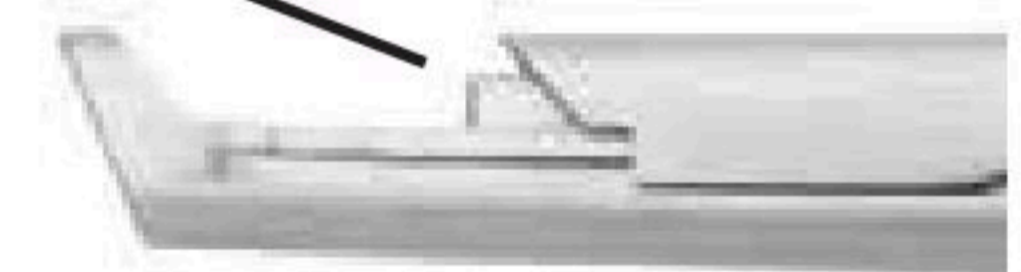

40° UPWARD

Love Kerrison Punch

- 40° UPWARD Jaw angle
- Oversize handle



40° UPWARD JAW

20 cm/8" Shaft	Bite Size
PS GT 4082	2 mm
PS GT 4083	3 mm
PS GT 4084	4 mm
PS GT 4085	5 mm



40° UPWARD

**SPINAL SURGERY**
**LAMINECTOMY PUNCH**
**Long Anterior Kerrison Laminectomy Punch**

40° UPWARD Jaw angle  
 With special Titanium coating on surface  
 Extra long shaft for Thoracic approach  
 Bone ejector

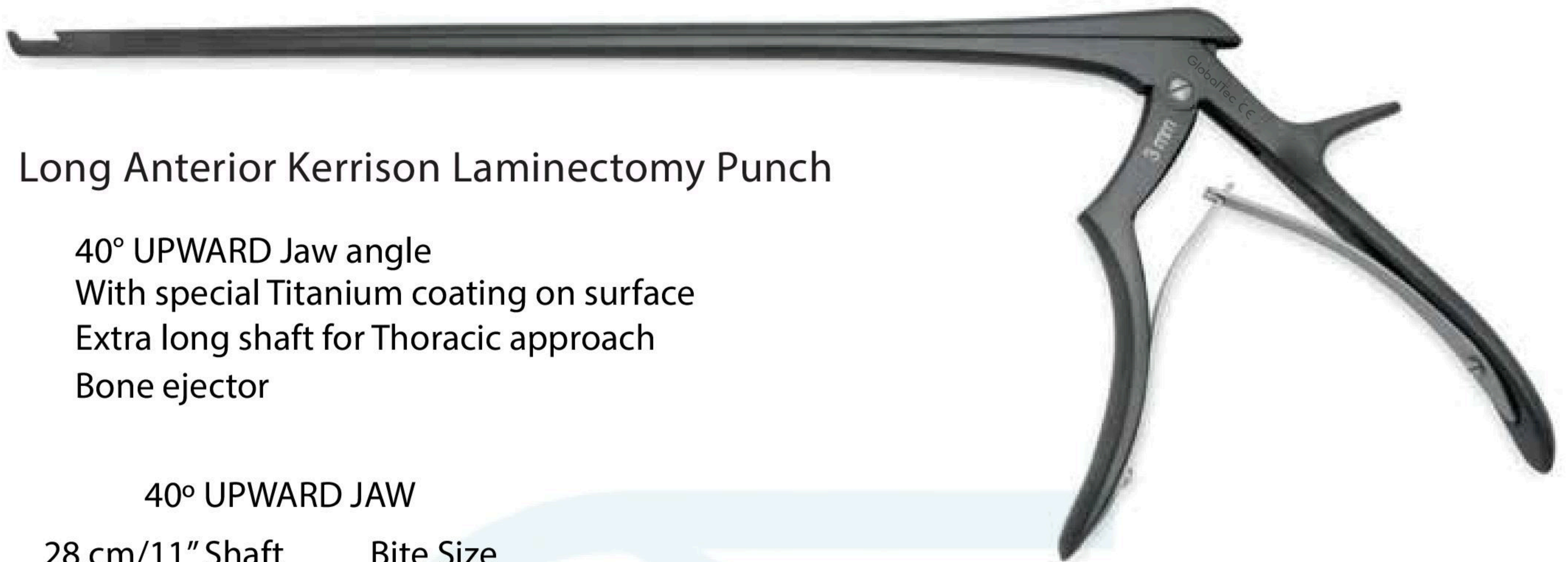
**40° UPWARD JAW**

28 cm/11" Shaft	Bite Size
PS GT 4002 ETi	2 mm
PS GT 4003 ETi	3 mm
PS GT 4004 ETi	4 mm
PS GT 4005 ETi	5 mm
PS GT 4006 ETi	6 mm

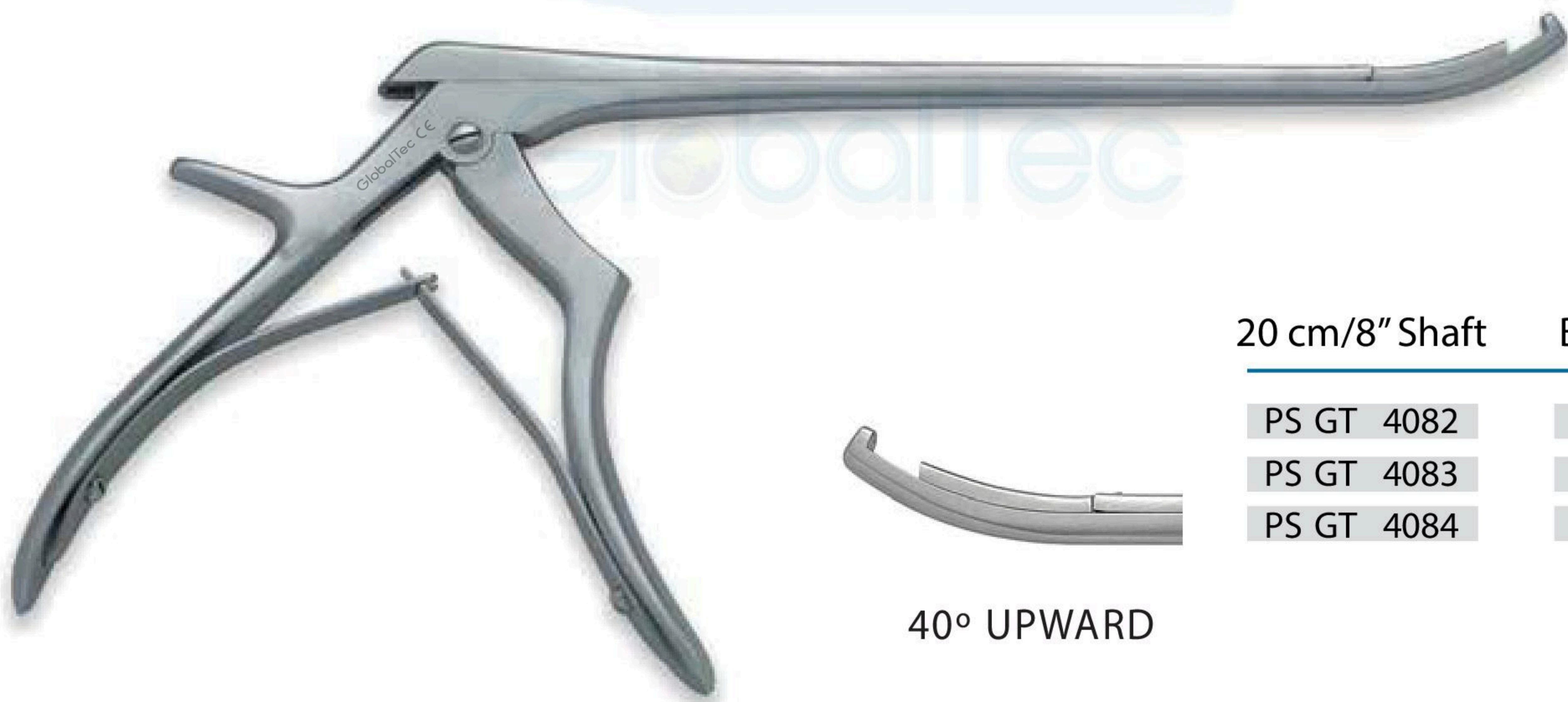

**40° UPWARD**
**Curved Foramenotomy Punch**

40° UPWARD Jaw angle  
 Curved shaft designed to improve access to the Foramen



20 cm/8" Shaft	Bite Size
PS GT 4082	2 mm
PS GT 4083	3 mm
PS GT 4084	4 mm

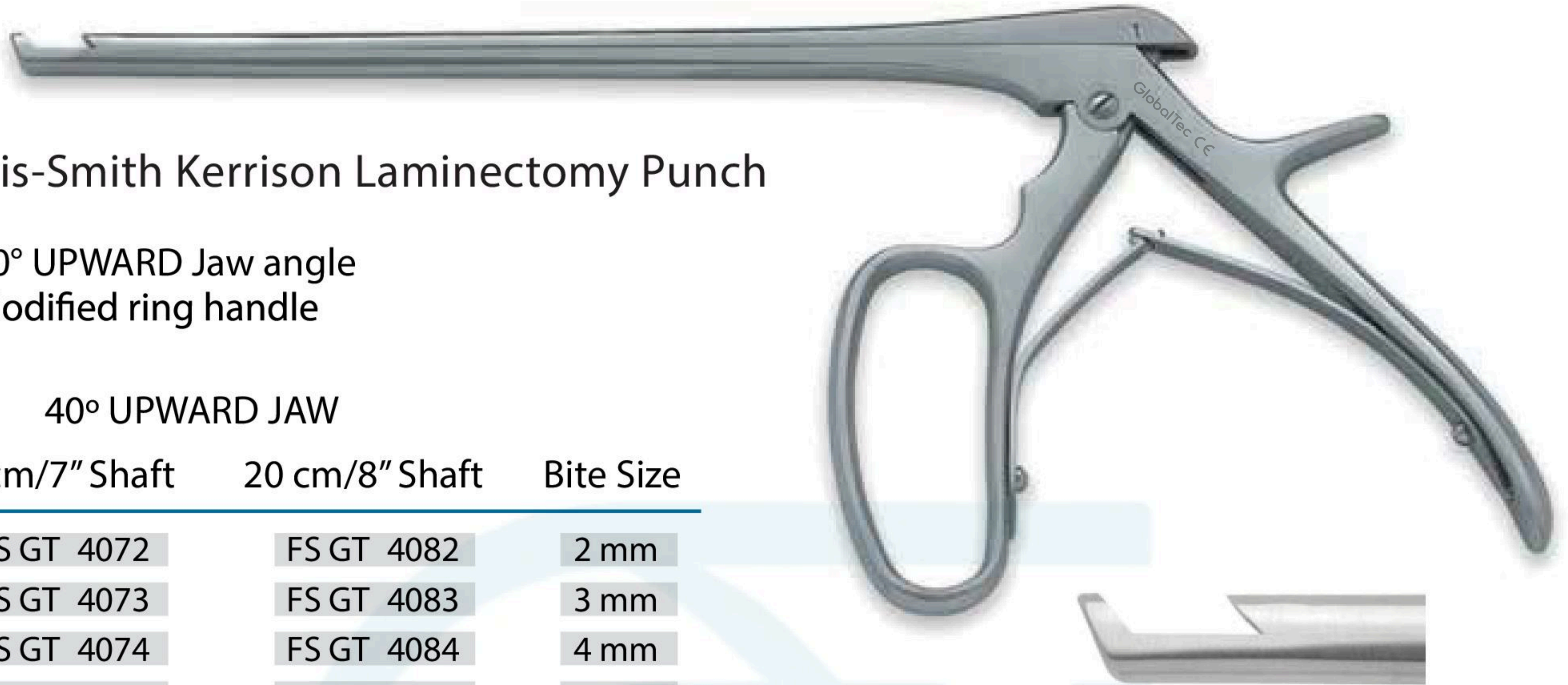

**40° UPWARD**

**SPINAL SURGERY**
**LAMINECTOMY PUNCH**

**Ferris-Smith Kerrison Laminectomy Punch**

- 40° UPWARD Jaw angle
- Modified ring handle

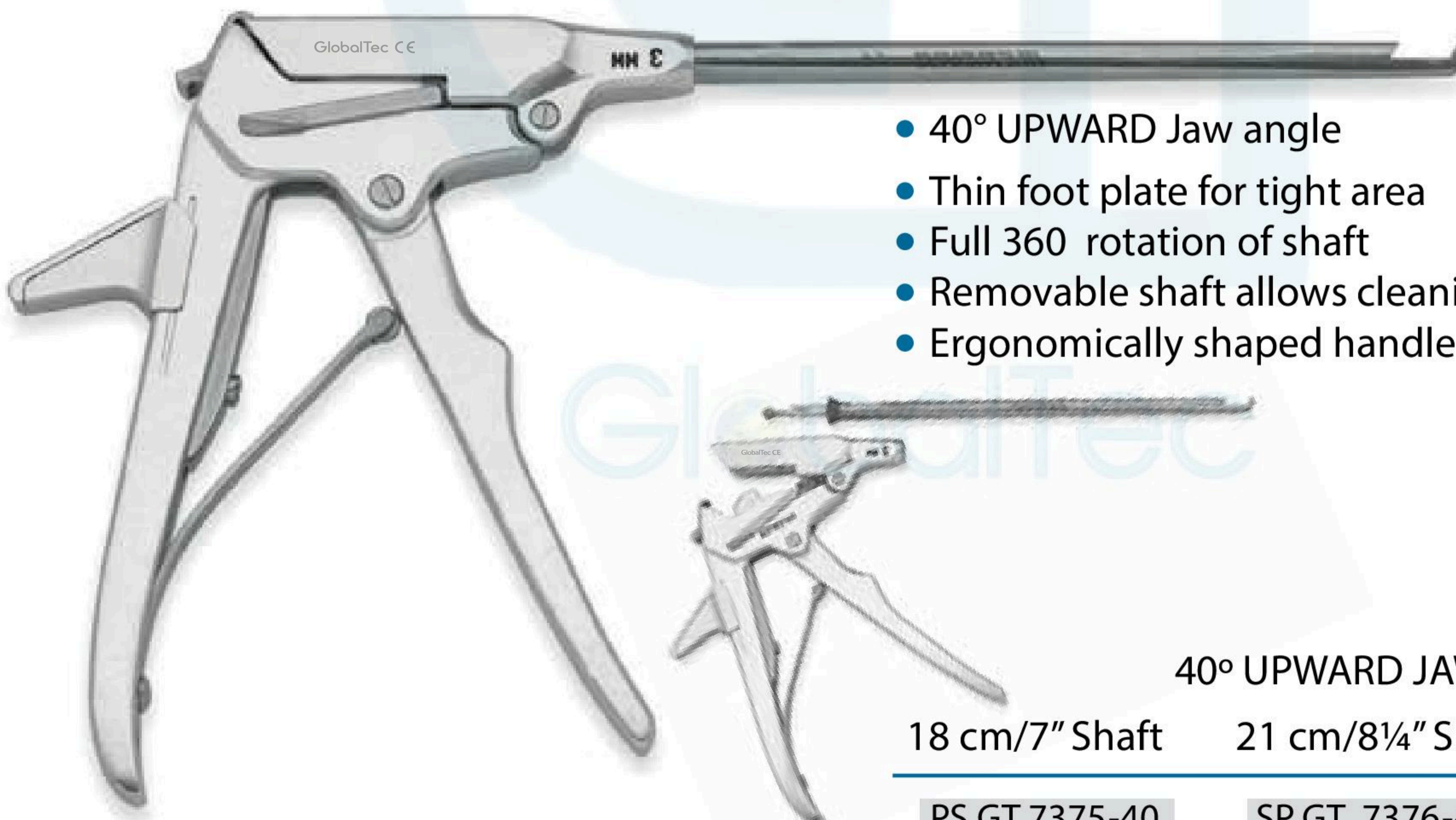
**40° UPWARD JAW**

18 cm/7" Shaft	20 cm/8" Shaft	Bite Size
PS GT 4072	FS GT 4082	2 mm
PS GT 4073	FS GT 4083	3 mm
PS GT 4074	FS GT 4084	4 mm
PS GT 4075	FS GT 4085	5 mm
PS GT 4076	FS GT 4086	6 mm

**40° UPWARD**
**Osteo-Rotating Punch**

- 40° UPWARD Jaw angle
- Thin foot plate for tight area
- Full 360 rotation of shaft
- Removable shaft allows cleaning & replacement
- Ergonomically shaped handle

**40° UPWARD JAW**

18 cm/7" Shaft	21 cm/8¼" Shaft	Bite Size
PS GT 7375-40	SP GT 7376-40	0.6 mm
PS GT 7375-41	SP GT 4083-41	1 mm
PS GT 7375-42	SP GT 4084-42	2 mm
PS GT 7375-43	SP GT 4085-43	3 mm
PS GT 7375-44	SP GT 4086-44	4 mm

SPINAL SURGERY

**DISC RONGEURS**

Intervertebral Disc Rongeur

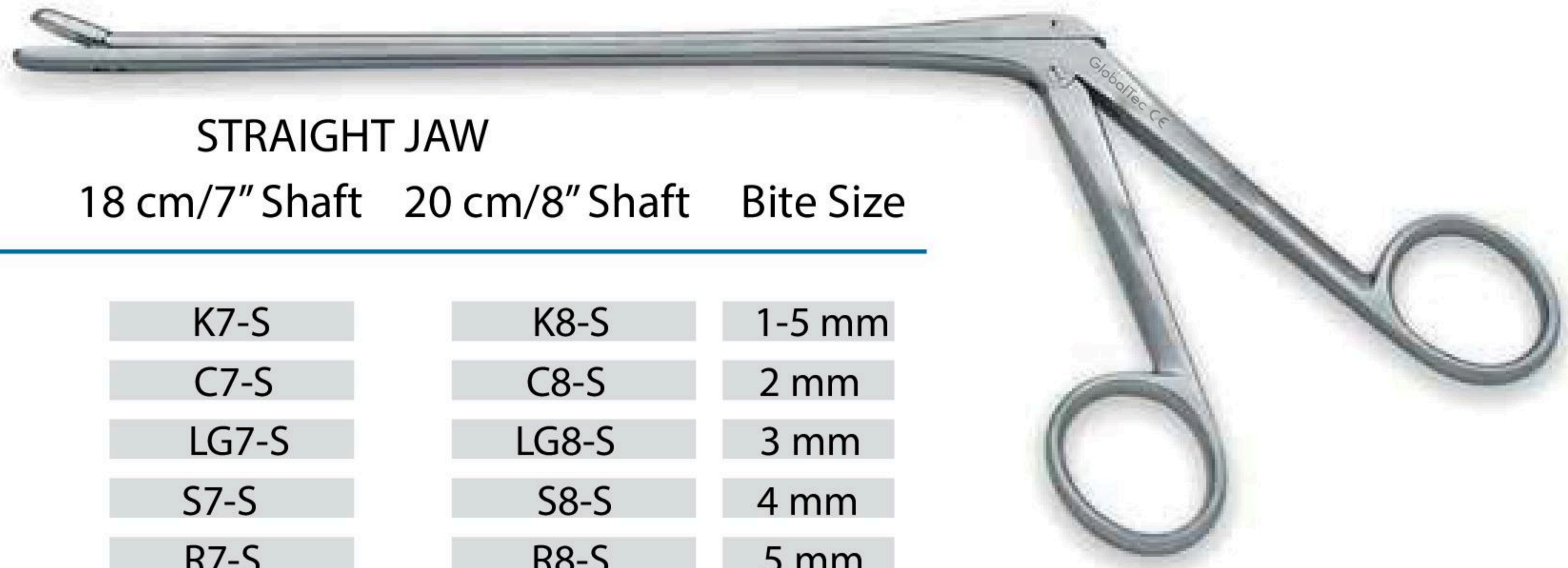

STRAIGHT JAW

15 cm/6" Shaft	18 cm/7" Shaft	20 cm/8" Shaft	Bite Size
K6-S	K7-S	K8-S	1-5 mm
C6-S	C7-S	C8-S	2 mm
LG6-S	LG7-S	LG8-S	3 mm
S6-S	S7-S	S8-S	4 mm
R6-S	R7-S	R8-S	5 mm
P6-S	P7-S	P8-S	6 mm
Q6-S	Q7-S	Q8-S	7 mm



40° ANGLED UPWARD JAW

15 cm/6" Shaft	18 cm/7" Shaft	20 cm/8" Shaft	Bite Size
K6-U	K7-U	K8-U	1-5 mm
C6-U	C7-U	C8-U	2 mm
LG6-U	LG7-U	LG8-U	3 mm
S6-U	S7-U	S8-U	4 mm
R6-U	R7-U	R8-U	5 mm
P6-U	P7-U	P8-U	6 mm
Q6-U	Q7-U	Q8-U	7 mm



40° ANGLED DOWNWARD JAW

15 cm/6" Shaft	18 cm/7" Shaft	20 cm/8" Shaft	Bite Size
K6-D	K7-D	K8-D	1-5 mm
C6-D	C7-D	C8-D	2 mm
LG6-D	LG7-D	VLG8-D	3 mm
S6-D	S7-D	S8-D	4 mm
R6-D	R7-D	R8-D	5 mm
P6-D	P7-D	P8-D	6 mm
Q6-D	Q7-D	Q8-D	7 mm

SPINAL SURGERY

DISC RONGEURS

Caspar Toothed Disc Rongeur

- Serrated and fenestrated jaws

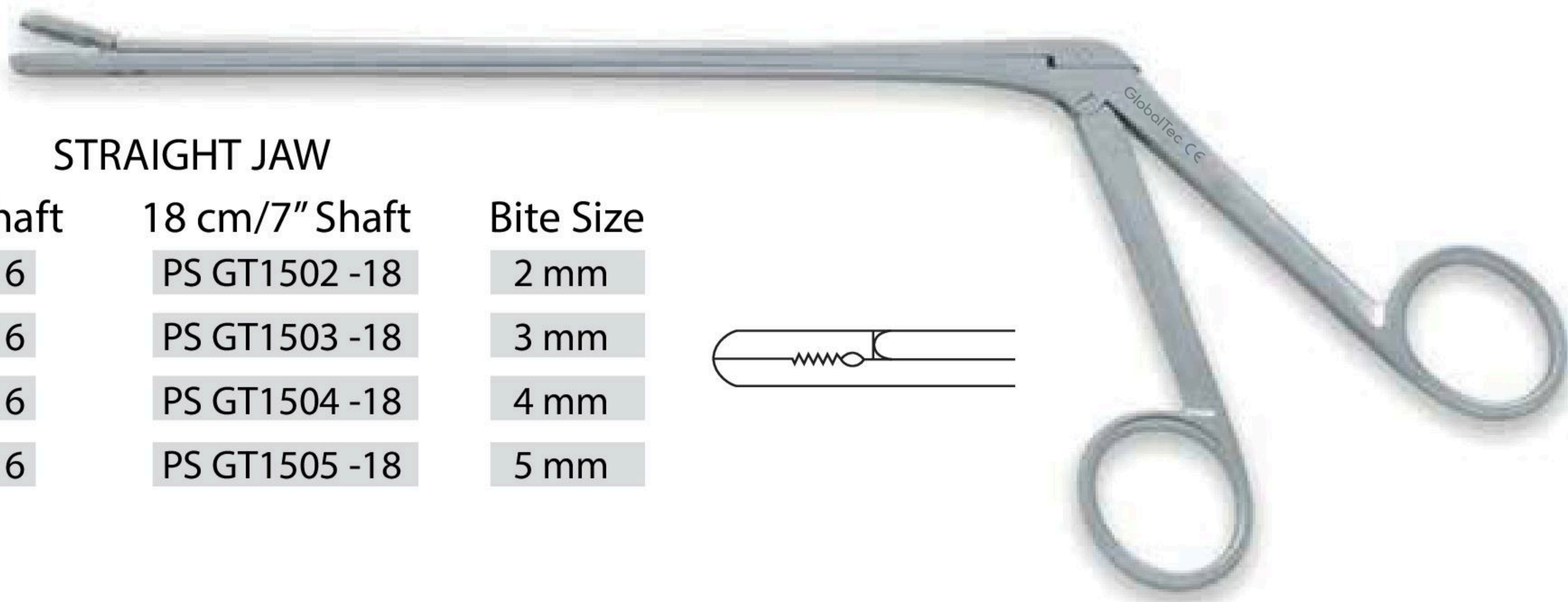

STRAIGHT JAW

16 cm/6¼" Shaft	18 cm/7" Shaft	Bite Size
PS GT1502 -16	PS GT1502 -18	2 mm
PS GT1503 -16	PS GT1503 -18	3 mm
PS GT1504 -16	PS GT1504 -18	4 mm
PS GT1505 -16	PS GT1505 -18	5 mm



UPWARD JAW

16 cm/6¼" Shaft	18 cm/7" Shaft	Bite Size
PS GT1602 -16	PS GT1602 -18	2 mm
PS GT1603 -16	PS GT1603 -18	3 mm
PS GT1604 -16	PS GT1604 -18	4 mm
PS GT1605 -16	PS GT1605 -18	5 mm

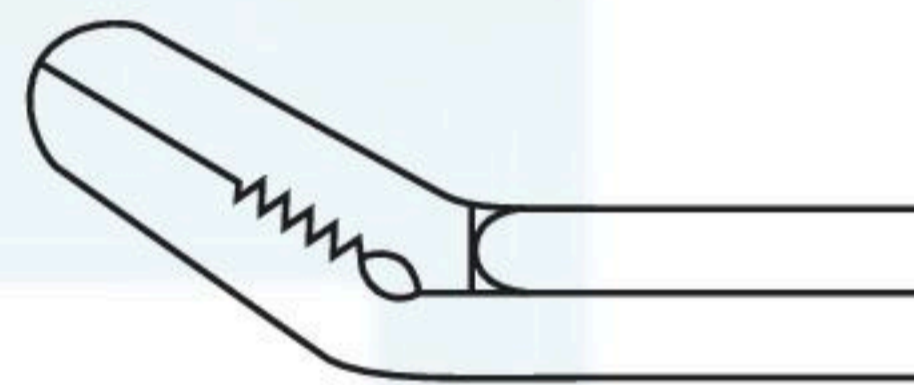

DOWNWARD JAW

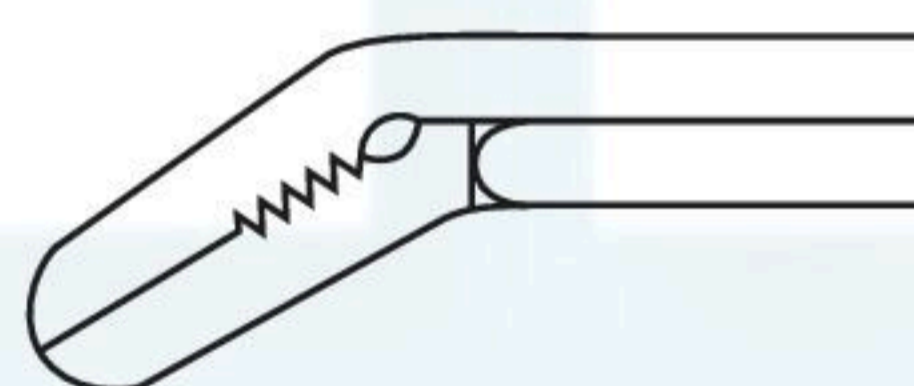

16 cm/6¼" Shaft	18 cm/7" Shaft	Bite Size
PS GT1702 -16	PS GT1702 -18	2 mm
PS GT1703 -16	PS GT1703 -18	3 mm
PS GT1704 -16	PS GT1704 -18	4 mm
PS GT1705 -16	PS GT1705 -18	5 mm

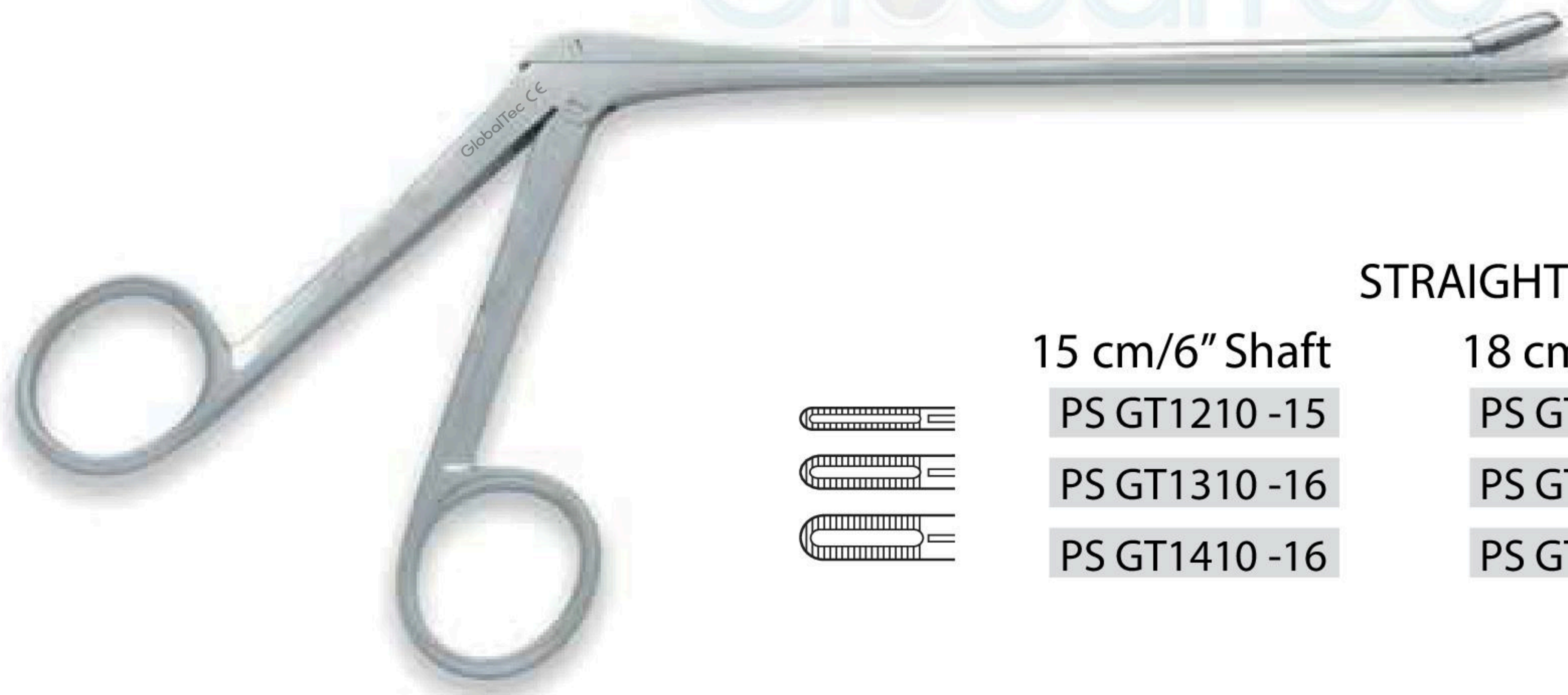

Schlesinger Toothed Rongeur

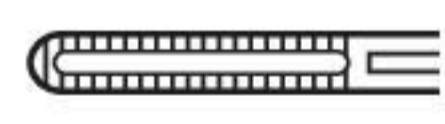

STRAIGHT JAW

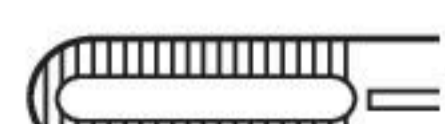
	15 cm/6" Shaft	18 cm/7" Shaft	Bite Size
	PS GT1210 -15	PS GT1210 -18	2 mm
	PS GT1310 -16	PS GT1310 -18	3 mm
	PS GT1410 -16	PS GT1410 -18	4 mm

**SPINAL SURGERY**
**DISC RONGEURS**
**Williams Discectomy Rongeur**

14 cm/5½" Shaft  
PS AS 1110 -14

Longer pattern  
23 cm/9" Shaft  
PS AS 1110 -23

Short 10mm length jaw

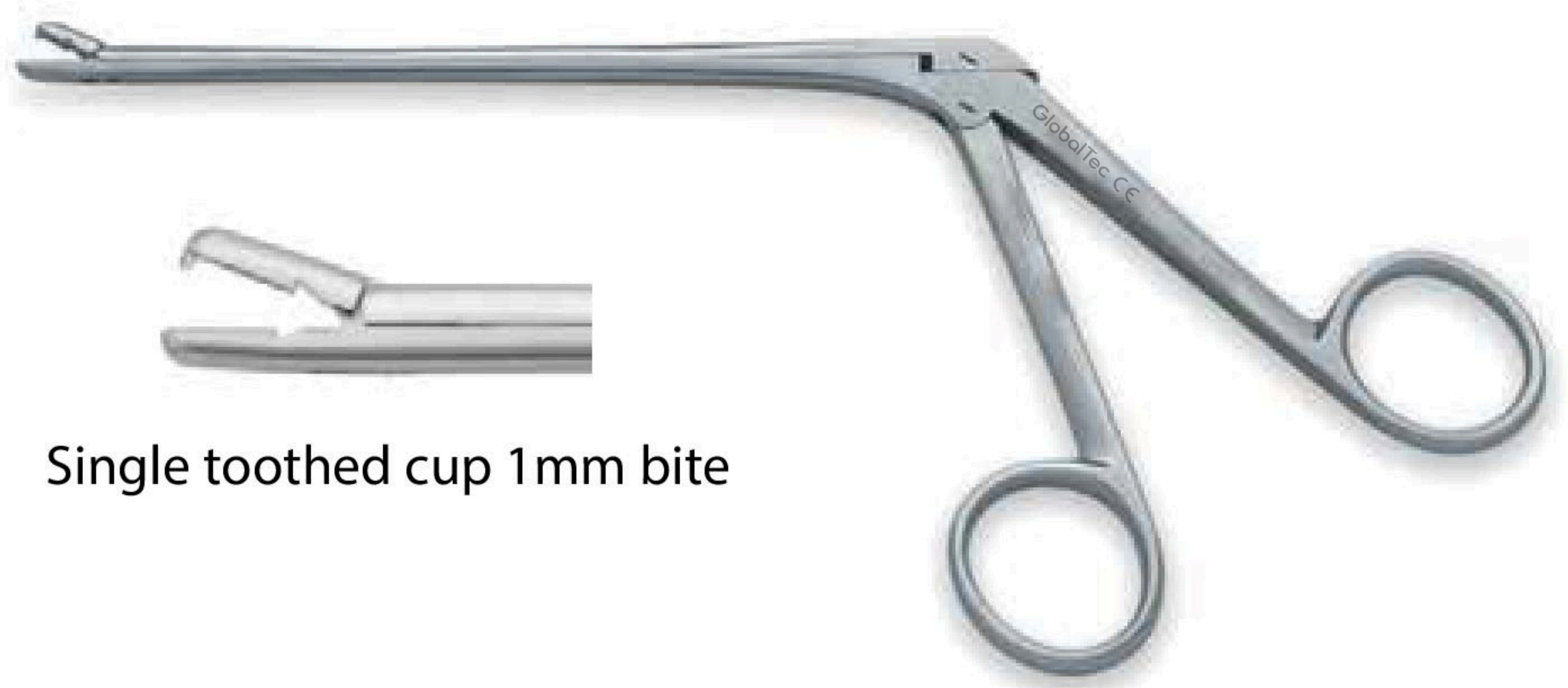

Single toothed cup 1mm bite

**'Pea Pod' Disc Rongeur**

Short 10mm length jaw

15 cm/6"      Bite Size

PS AS 1510 -15      2mm

PS AS 1610 -15      3mm

PS AS 1710 -15      4mm

13 cm/5¼"      Bite Size

PS AS1510 -13      2mm

Extra fine pattern 5mm length jaws

**Beck Disc Rongeur**

13 cm/5¼" Shaft  
2 cm bite size

PS AS 1910 -13

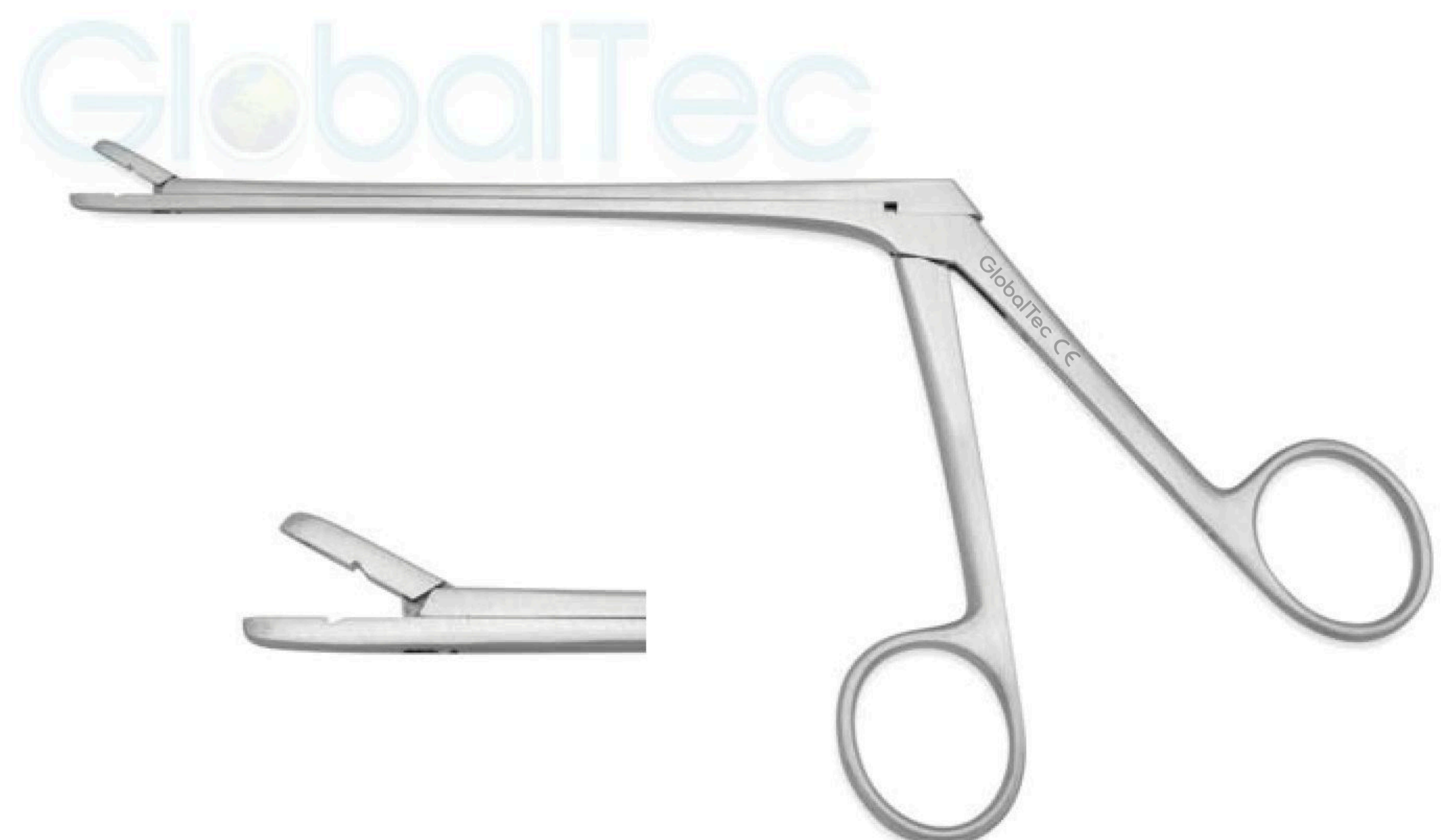

**SPINAL SURGERY**

**DISC RONGEURS**

**Munich Grasping Forceps**

118cm/7" Shaft length  
1x 2 teeth  
Straight jaw

PS AS1224 -18



Toothed Serrated Jaw

**Decker Ronguer**

15cm/6" working length  
Straight 6mm jaw

PS AS1223 -15

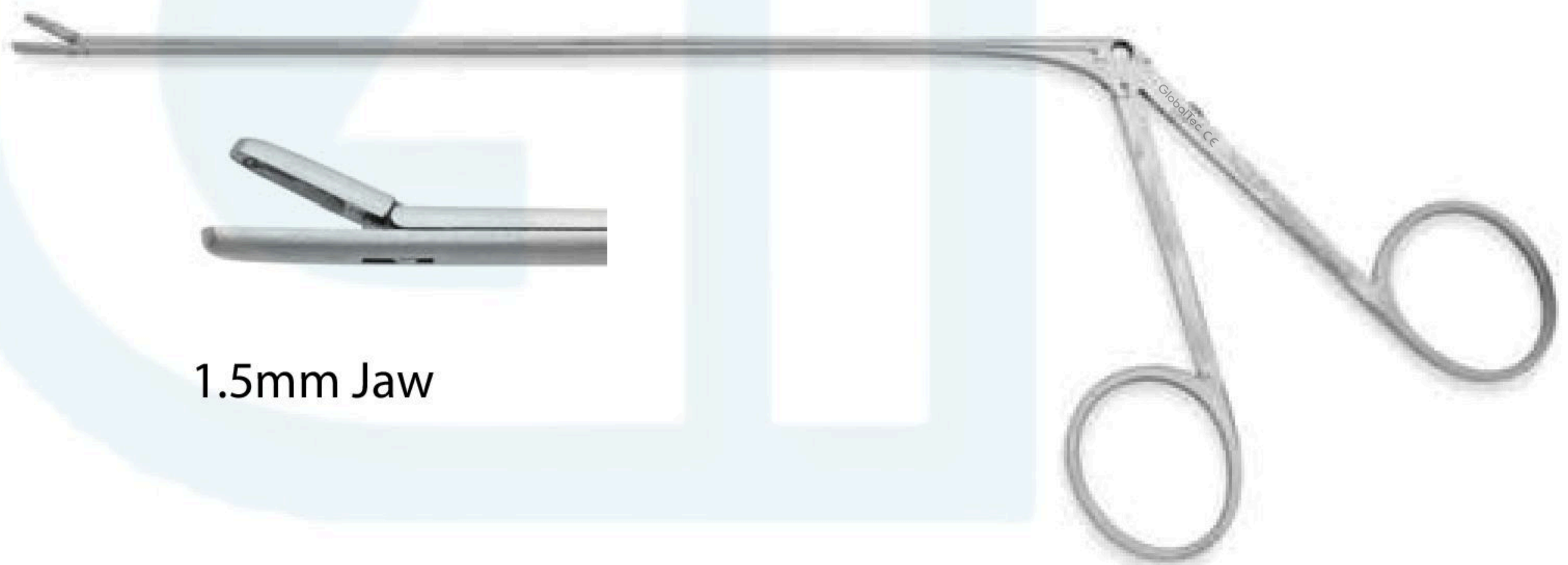

1.5mm Jaw

**Nicola Micro Cupped Biopsy Forceps**

16.5cm/6 1/2" Shaft

PS AS1222 -16

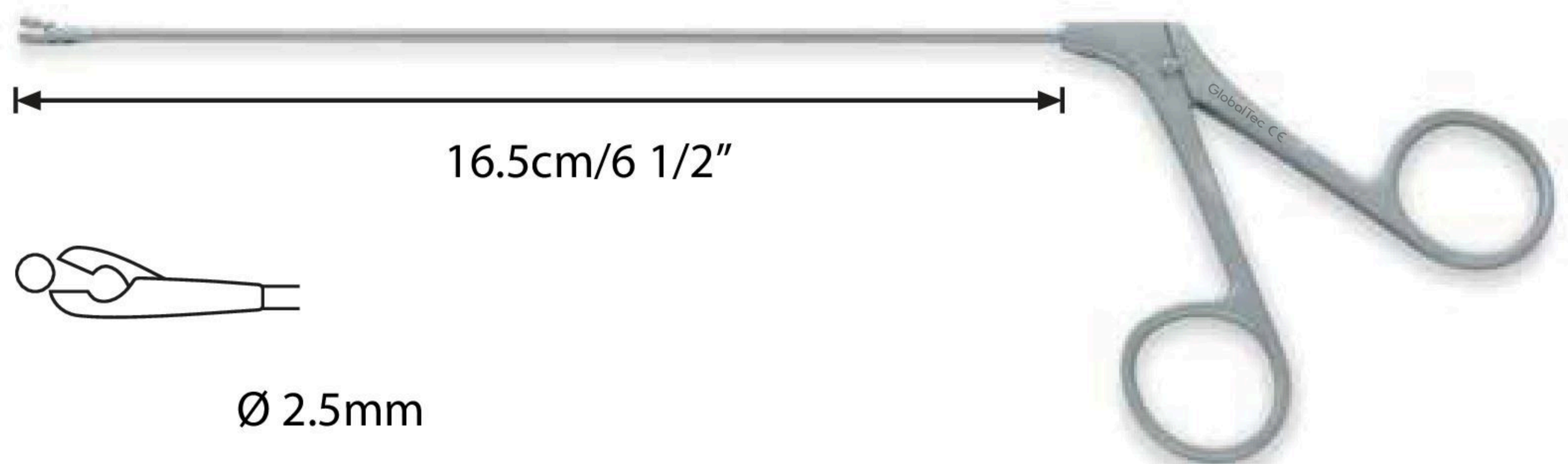

16.5cm/6 1/2"

Ø 2.5mm

SPINAL SURGERY

DISC RONGEURS

'Clean Wave' Intervertebral Disc Rongeur



• STRAIGHT JAW

15cm/6" Shaft	18cm/7" Shaft	20cm/8" Shaft	Bite Size
K6-GT-SCW	K7-GT-SCW	K8-GT-SCW	1.5 mm
C6-GT-SCW	C7-GT-SCW	C8-GT-SCW	2 mm
LG6-GT-SCW	LG7-GT-SCW	LG8-GT-SCW	3 mm
S6-GT-SCW	S7-GT-SCW	S8-GT-SCW	4 mm
R6-GT-SCW	R7-GT-SCW	R8-GT-SCW	5 mm
P6-GT-SCW	P7-GT-SCW	P8-GT-SCW	6 mm
Q6-GT-SCW	Q7-GT-SCW	Q8-GT-SCW	7 mm

• 40 ANGLED UPWARD JAW

15cm/6" Shaft	18cm/7" Shaft	20cm/8" Shaft	Bite Size
K6-GT-SCW	K7-GT-SCW	K8-GT-SCW	1.5 mm
C6-GT-SCW	C7-GT-SCW	C8-GT-SCW	2 mm
LG6-GT-SCW	LG7-GT-SCW	LG8-GT-SCW	3 mm
S6-GT-SCW	S7-GT-SCW	S8-GT-SCW	4 mm
R6-GT-SCW	R7-GT-SCW	R8-GT-SCW	5 mm
P6-GT-SCW	P7-GT-SCW	P8-GT-SCW	6 mm
Q6-GT-SCW	Q7-GT-SCW	Q8-GT-SCW	7 mm



• Open design of shaft allows cleaning of shaft

• 40 ANGLED DOWNWARD JAW

15cm/6" Shaft	18cm/7" Shaft	20cm/8" Shaft	Bite Size
K6-GT-SCW	K7-GT-SCW	K8-GT-SCW	1.5 mm
C6-GT-SCW	C7-GT-SCW	C8-GT-SCW	2 mm
LG6-GT-SCW	LG7-GT-SCW	LG8-GT-SCW	3 mm
S6-GT-SCW	S7-GT-SCW	S8-GT-SCW	4 mm
R6-GT-SCW	R7-GT-SCW	R8-GT-SCW	5 mm
P6-GT-SCW	P7-GT-SCW	P8-GT-SCW	6 mm
Q6-GT-SCW	Q7-GT-SCW	Q8-GT-SCW	7 mm

SPINAL SURGERY

DISC RONGEURS

Ferris-Smith Disc Rongeur  
Ring handle

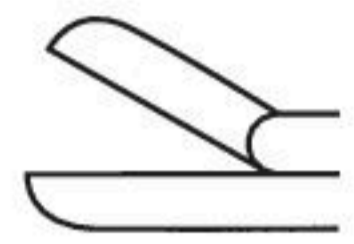

STRAIGHT JAW

18cm/7" Shaft	20cm/8" Shaft	Bite Size
GTRS GT 0072	TGTRS GT 0082	2 mm
GTRS GT 0073	GTRS GT 0082	3 mm
GTRS GT 0074	GTRS GT 0082	4 mm
GTRS GT 0075	GTRS GT 0082	5 mm



40 UPWARD JAW

18cm/7" Shaft	20cm/8" Shaft	Bite Size
PSRU-GT 0072	PSRU-AS 0082	2 mm
PSRU-GT 0073	PSRU-AS 0083	3 mm
PSRU-GT 0074	PSRU-AS 0084	4 mm
PSRU-GT 0075	PSRU-AS 0085	5 mm

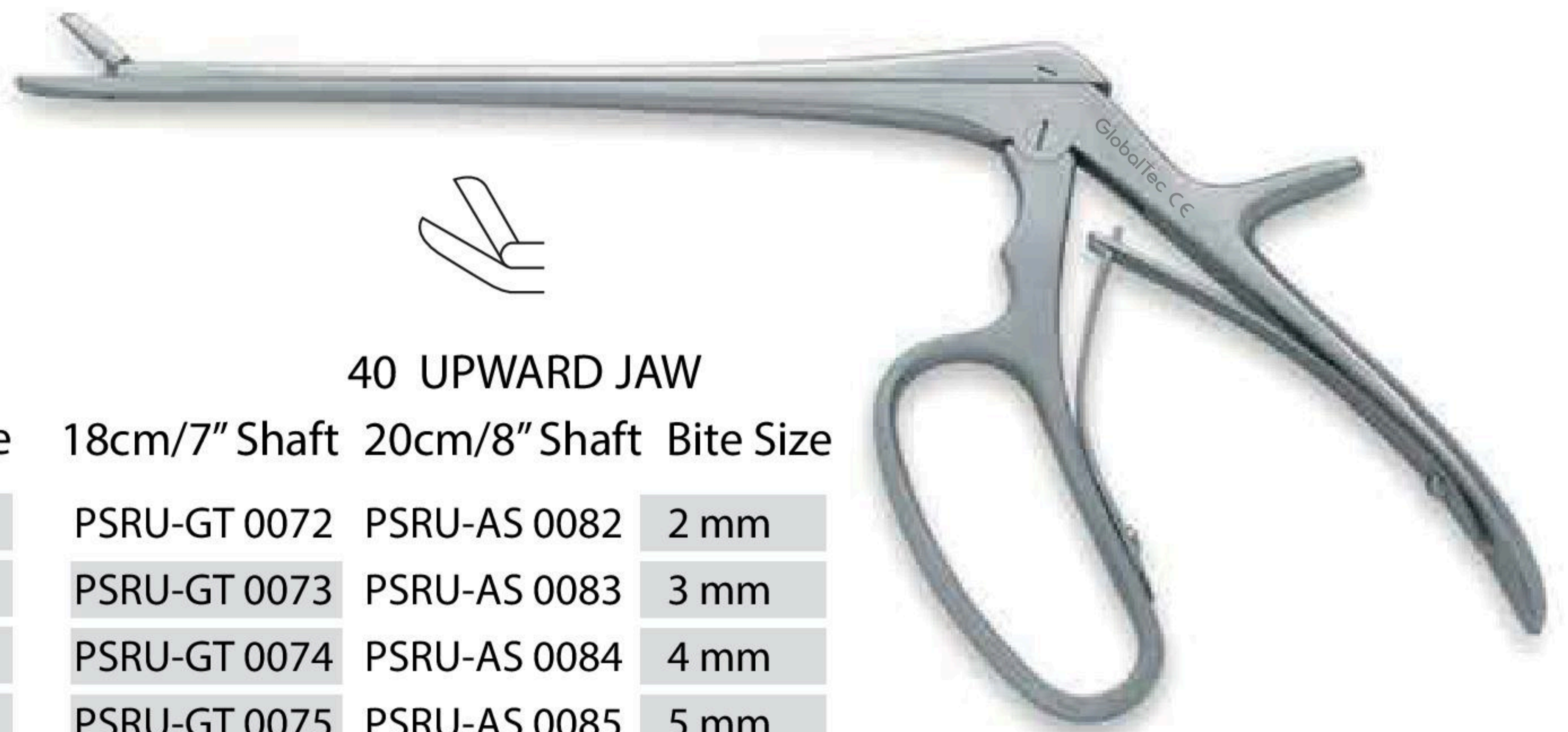

Anterior Disc Rongeur

28cm/11" Shaft

Longer 28cm shaft for greater reach in the Anterior approach

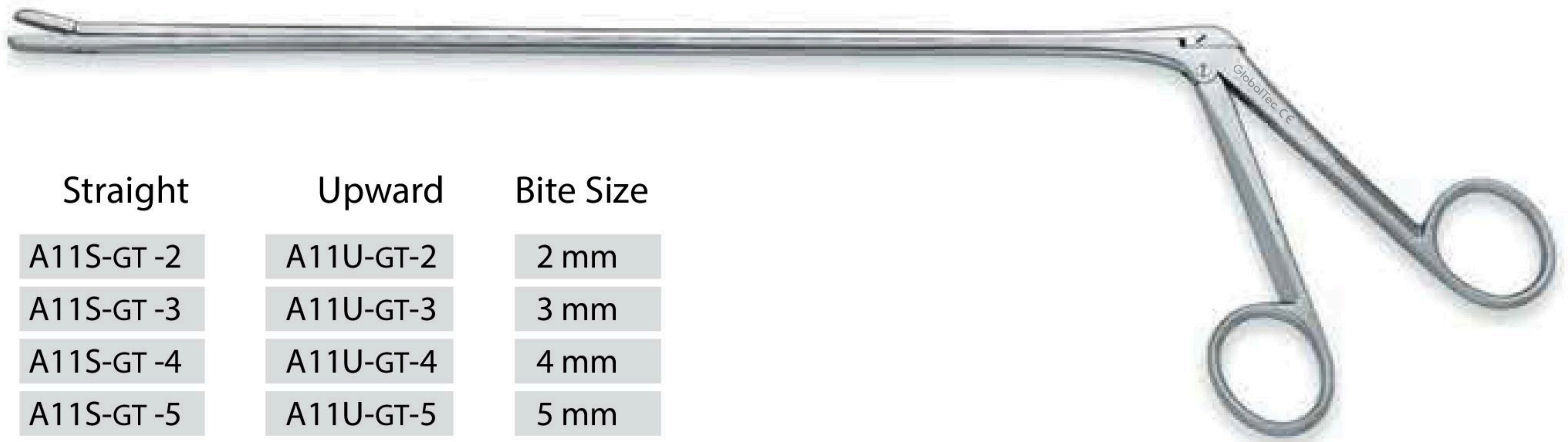

Straight	Upward	Bite Size
A11S-GT -2	A11U-GT-2	2 mm
A11S-GT -3	A11U-GT-3	3 mm
A11S-GT -4	A11U-GT-4	4 mm
A11S-GT -5	A11U-GT-5	5 mm

Anterior Long Rongeur

35cm/13 1/2" Shaft

Extra long length shaft for deeper areas



Straight	Upward	Bite Size	
GT7390-GT -52	--	2.4 mm	
GT7390 -GT-54	GT7390-GT-84	4 mm	
GT7390-GT -56	--	6 mm	with teeth
GT7390-GT -58	GT7390-GT-88	8 mm	with teeth

**SPINAL SURGERY**
**BONE NIBBLERS & CUTTERS**
**Lempert Bone Nibbler**

- Single Action
- 19cm/7 1/2"

3mm Bite  
PS1001-19

PS GT 1001-19

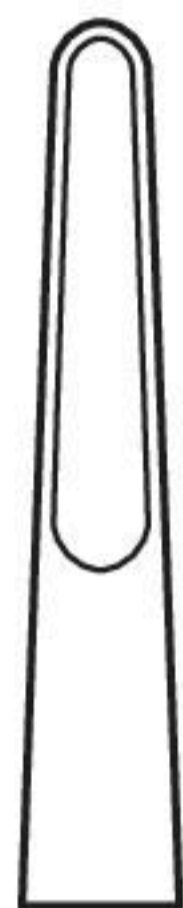
**Luer Bone Nibbler**

- Single Action
- 18cm/7"

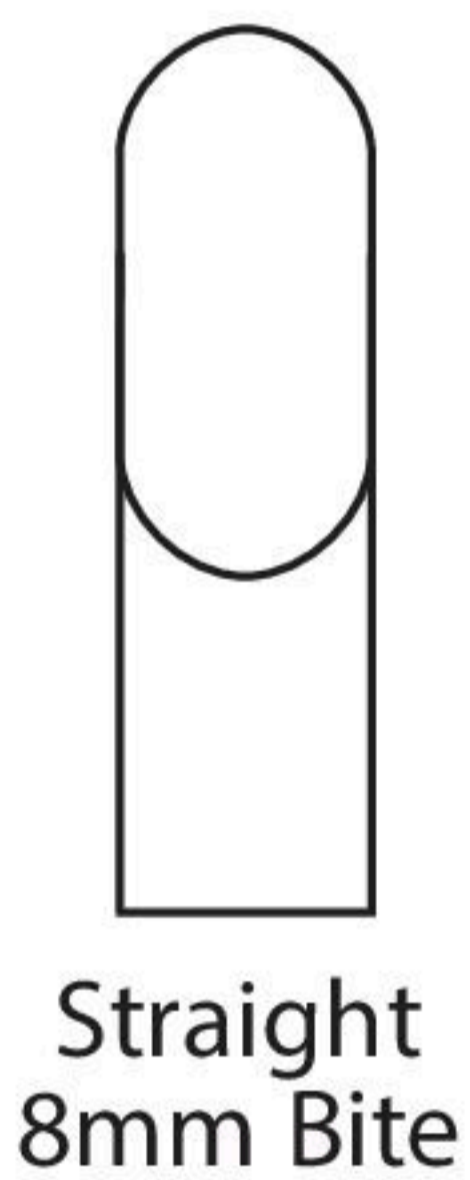

Straight  
8mm Bite  
PS GT 1004-18

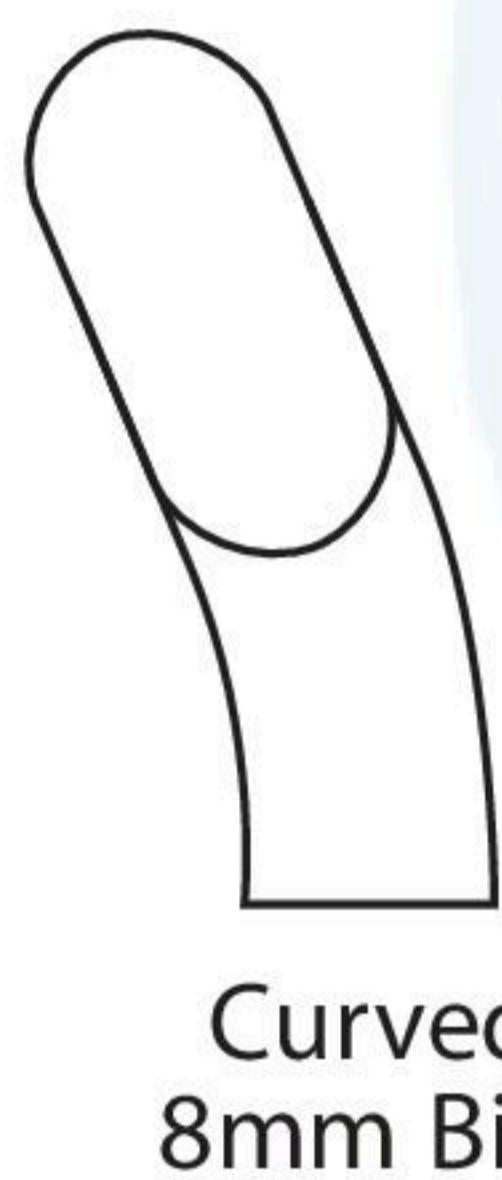

Curved  
8mm Bite  
PS GT 1005-18

**Adsons Bone Nibbler**

- Single Action
- 20cm/8"

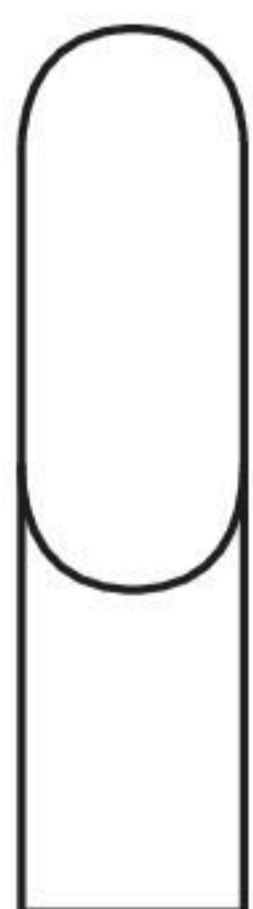

7mm Bite

PS GT 1040-20



**SPINAL SURGERY**
**BONE NIBBLERS & CUTTERS**
**Pennybacker Bone Nibbler**

- Single Action
- 20cm/8"

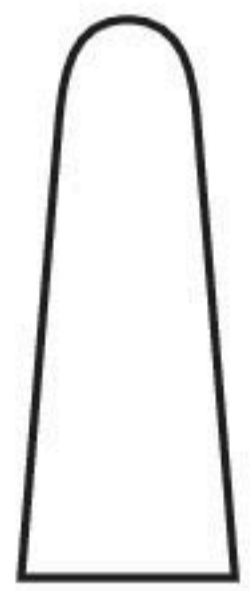

4mm Bite

PS GT 1041-20

**Northfields Bone Nibbler**

- Single Action
- 20cm/8"

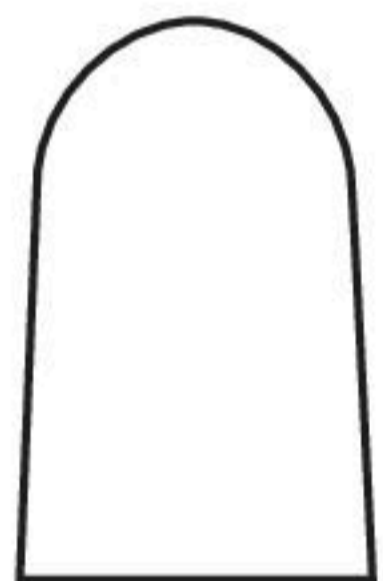

10mm Bite

PS GT 1042-20

**'Rat Toothed' Bone Nibbler**

- Single Action
- 21cm/8 1/4"

PS GT 1031-21

8mm Bite

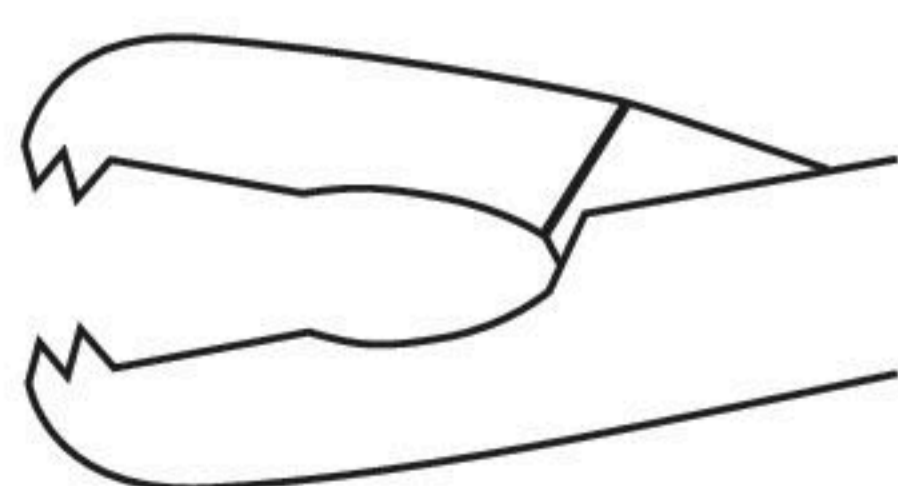

- 3 x 3 Teeth



**SPINAL SURGERY**

**BONE NIBBLERS & CUTTERS**

**Zielke Intervertebral Rongeur**

Angled Parallel Jaws

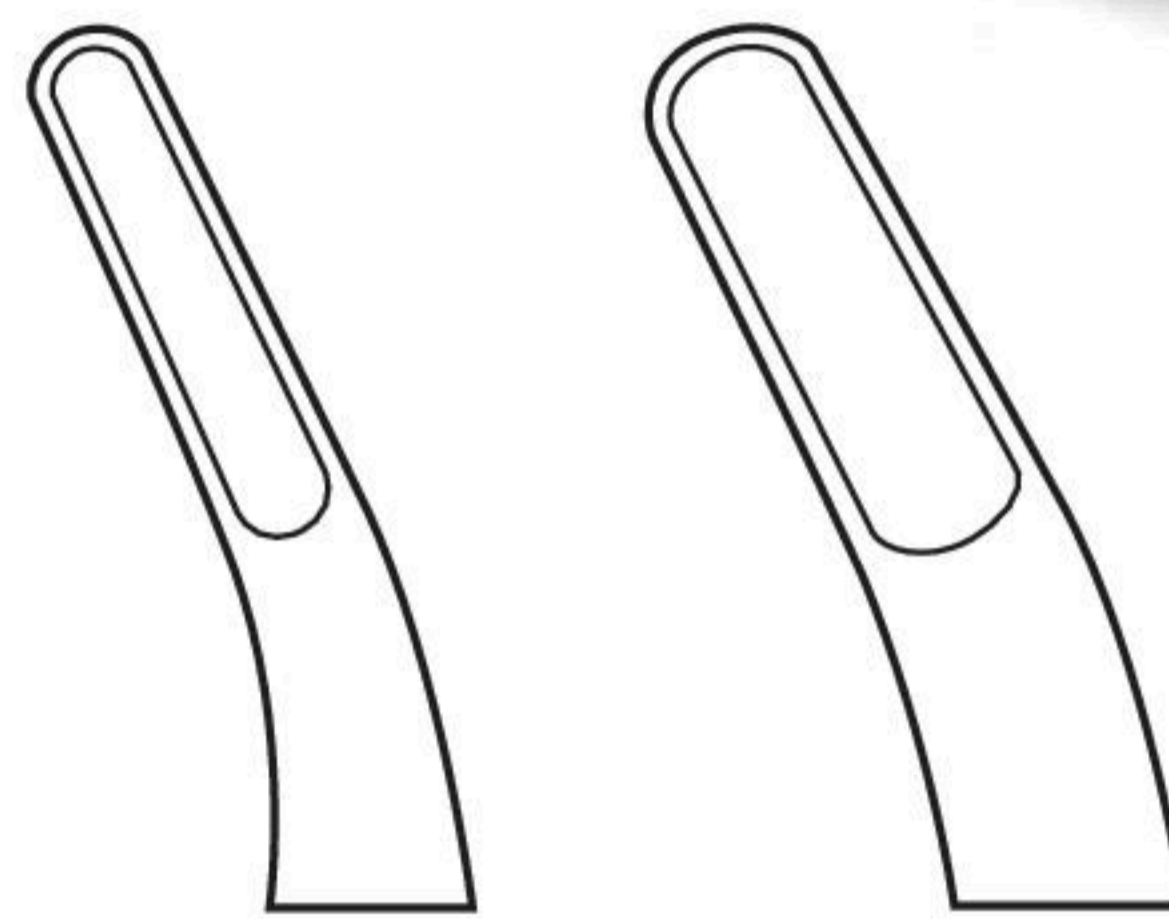

3mm Bite      5mm Bite

21cm/8¼"	25cm/9¾"	BiteSize
PS AS 1026 - 21	PS AS 1026 - 25	3mm
PS AS 1027 - 21	PS AS 1027 - 25	5mm

**Zielke Intervertebral Rongeur**

20cm/8"  
Angled Jaws

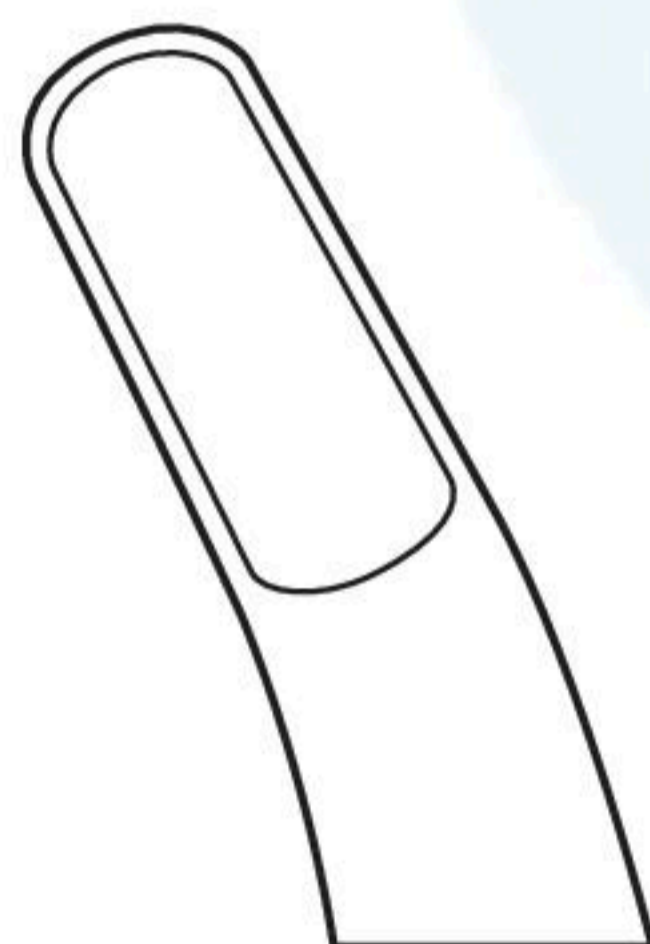
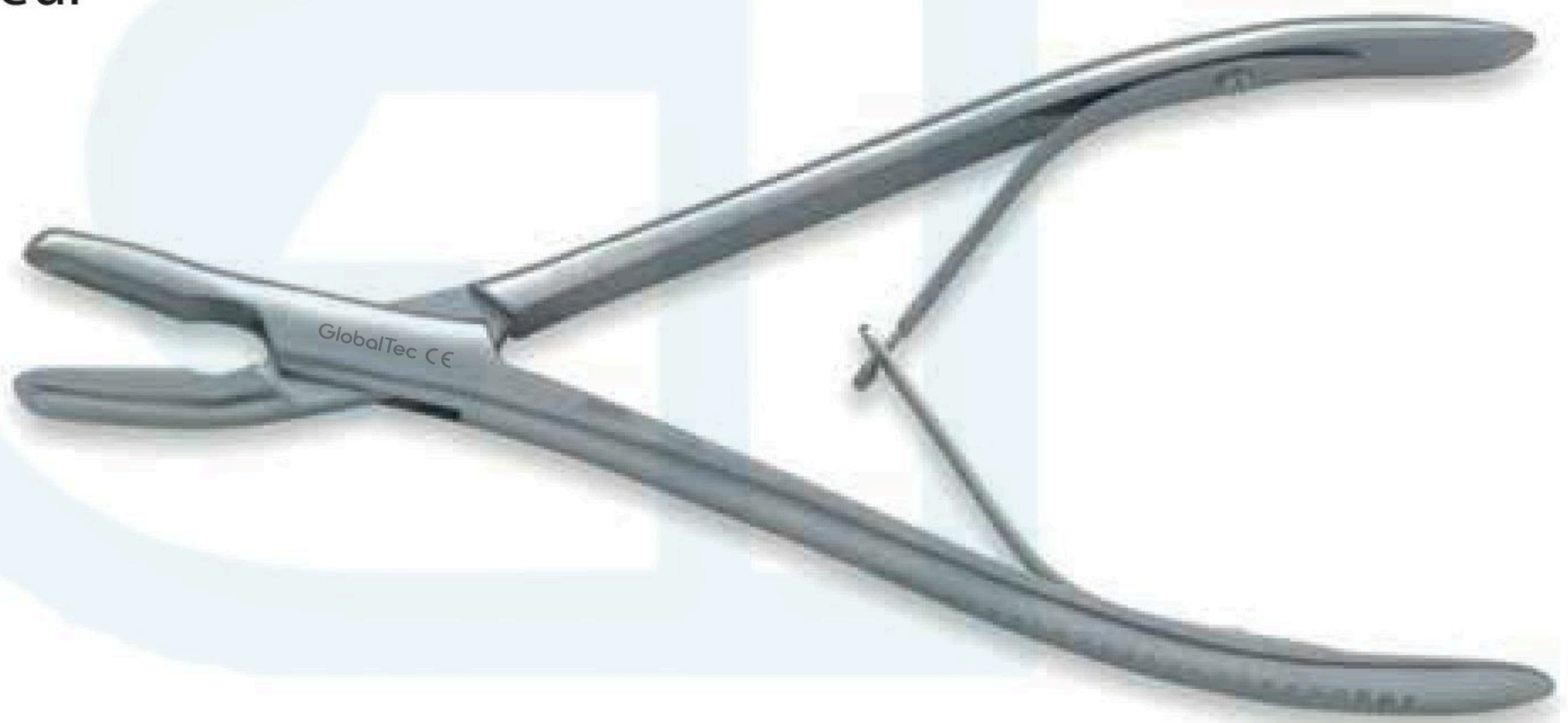

8mm Bite  
PS AS 1043-20

**Beyer Bone Nibbler**

Curved Double Action  
18cm/7"

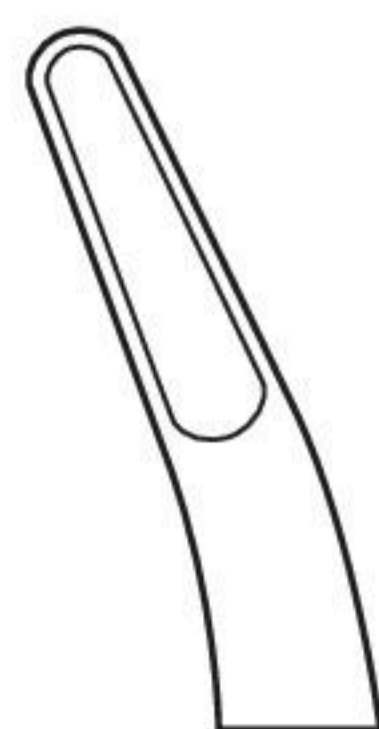

4mm Bite  
PS AS 1002-18

**SPINAL SURGERY**

**BONE NIBBLERS & CUTTERS**

**Zielke Intervertebral Rongeur**

Angled Parallel Jaws

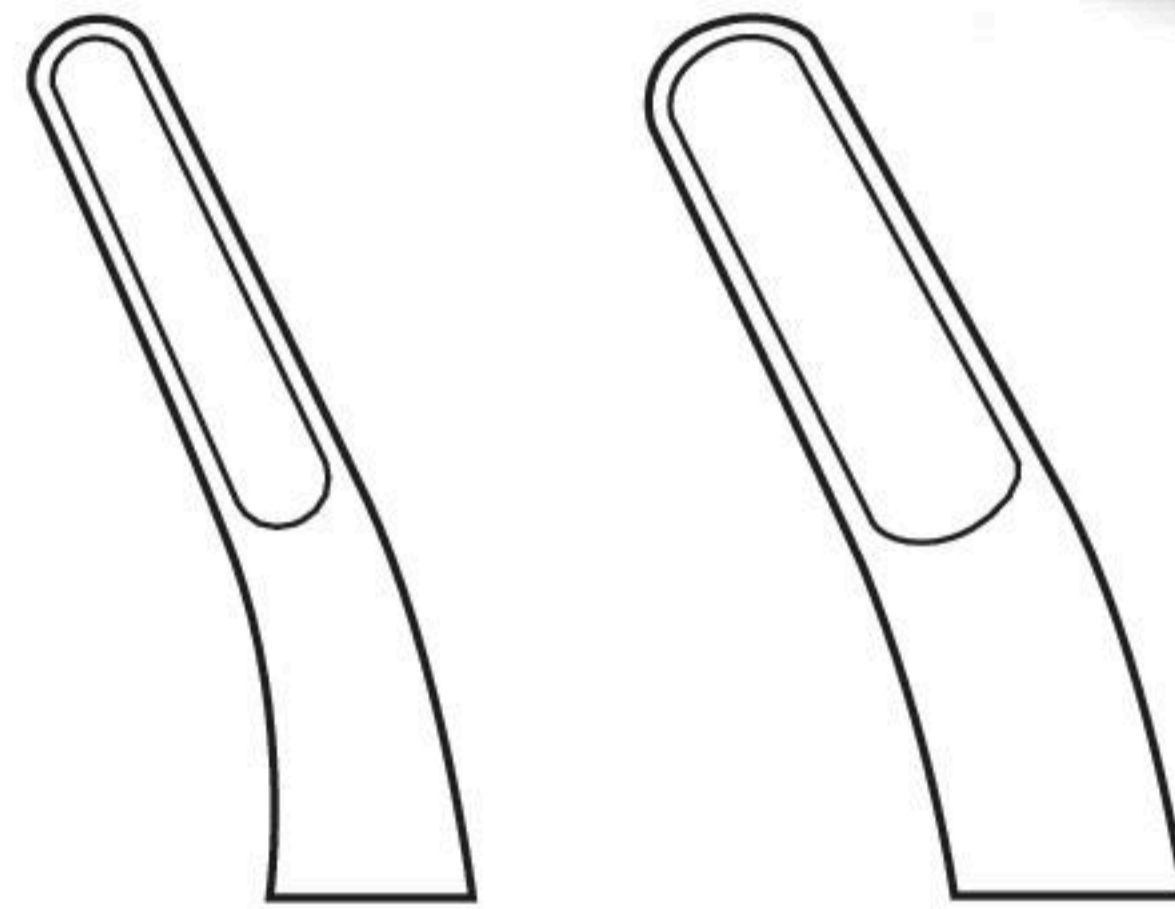

3mm Bite      5mm Bite

21cm/8¼"	25cm/9¾"	BiteSize
PS AS 1026 - 21	PS AS 1026 - 25	3mm
PS AS 1027 - 21	PS AS 1027 - 25	5mm

**Zielke Intervertebral Rongeur**

20cm/8"  
Angled Jaws

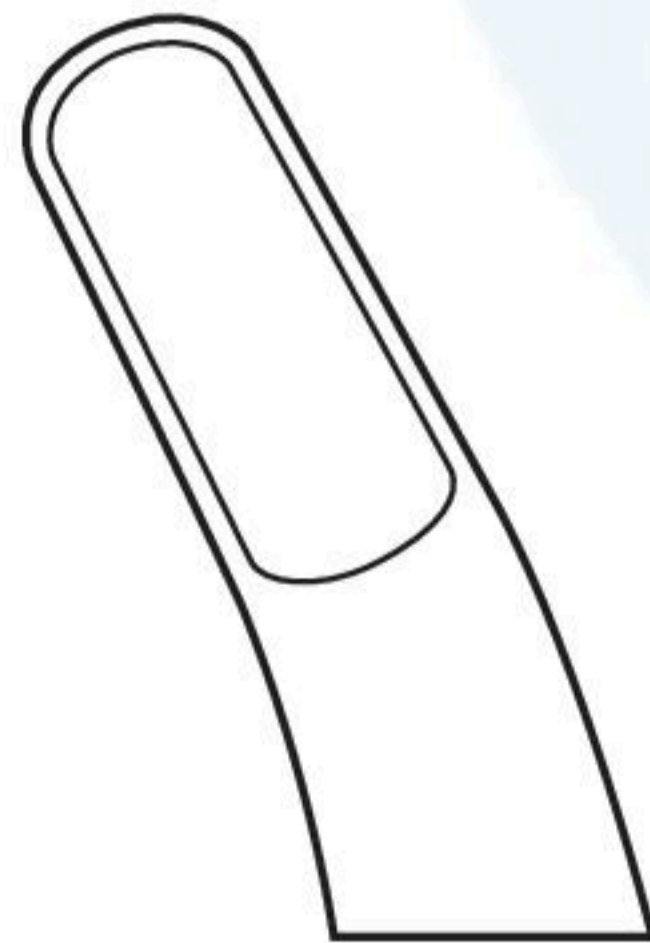
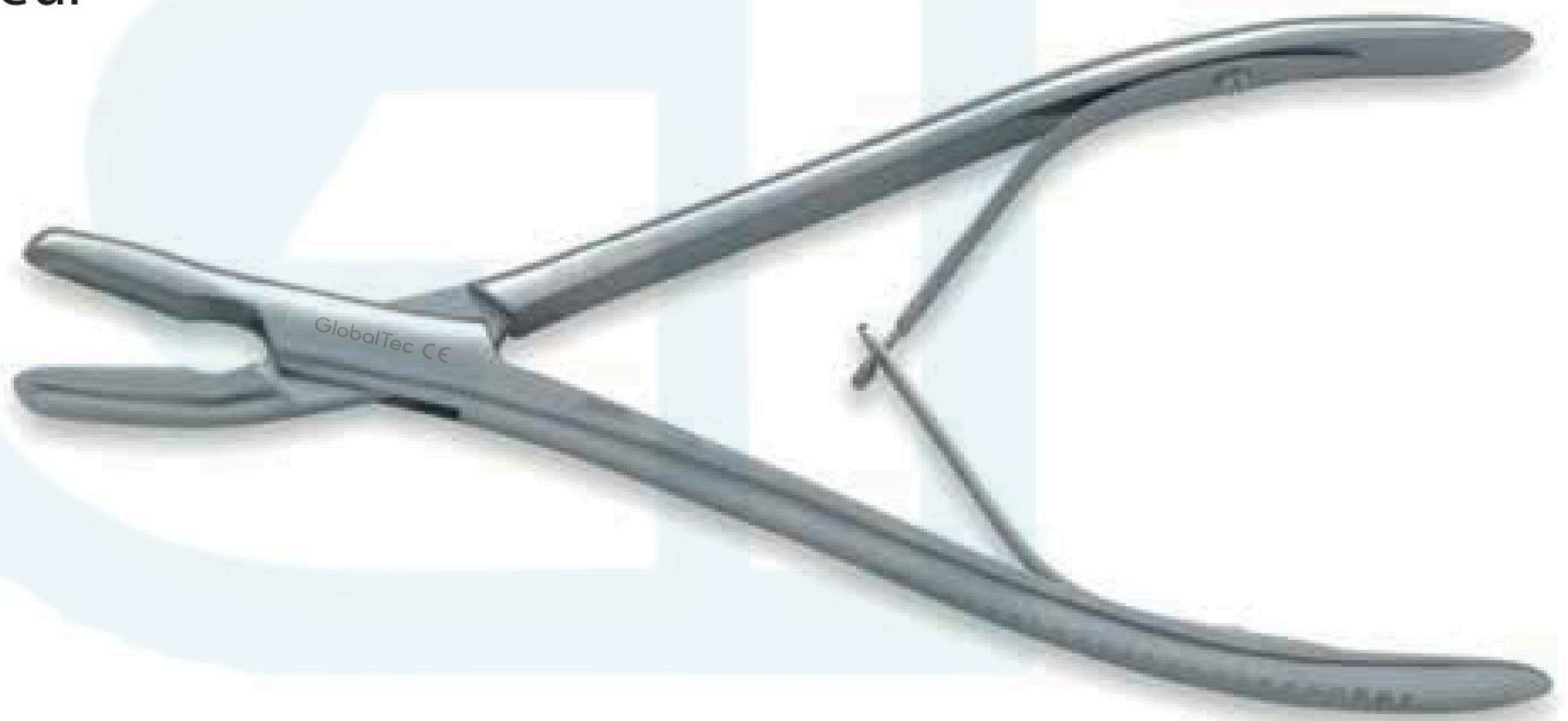

8mm Bite  
PS AS 1043-20

**Beyer Bone Nibbler**

Curved Double Action  
18cm/7"

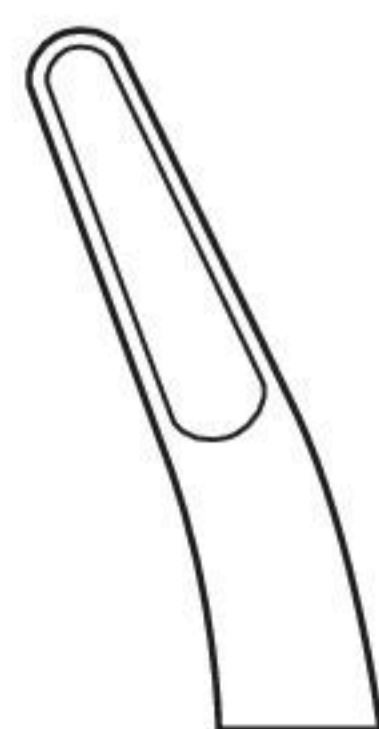

4mm Bite  
PS AS 1002-18

**SPINAL SURGERY**

**BONE NIBBLERS**

**Stille-Luer Bone Nibbler**

Double Action  
22cm/8¾"

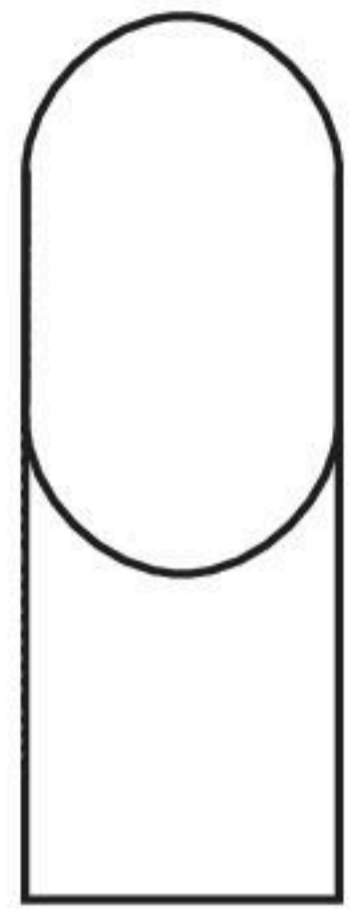

Straight  
10mm Bite

PS GT 1006-22

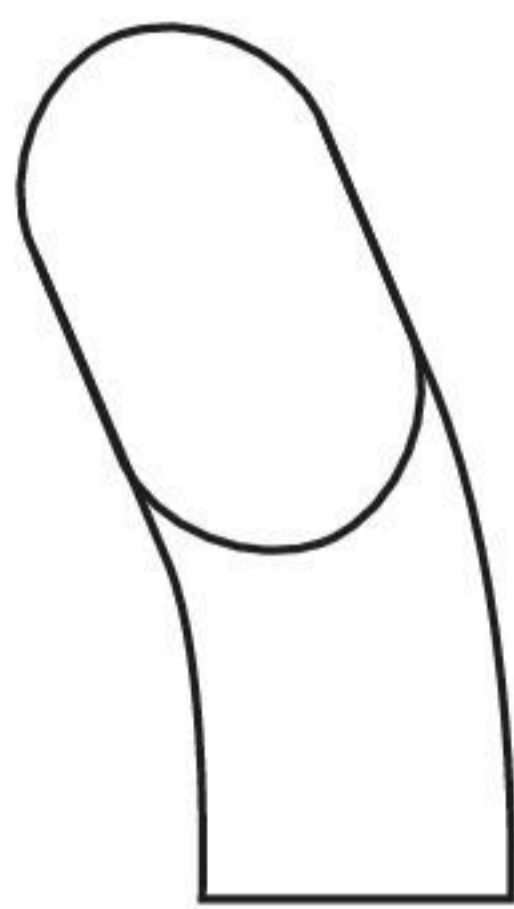

Curved  
10mm Bite

PS GT 1007-22



**Leksell Bone Nibbler**

Double Action Angled  
24cm/9½"

Angled Jaw      Bite Size

PS GT 1018-24      3mm

PS GT 1019-24      4mm

PS GT 1020-24      5mm

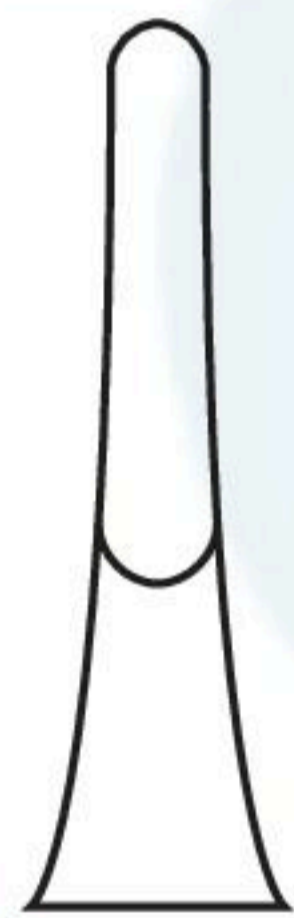

3mm

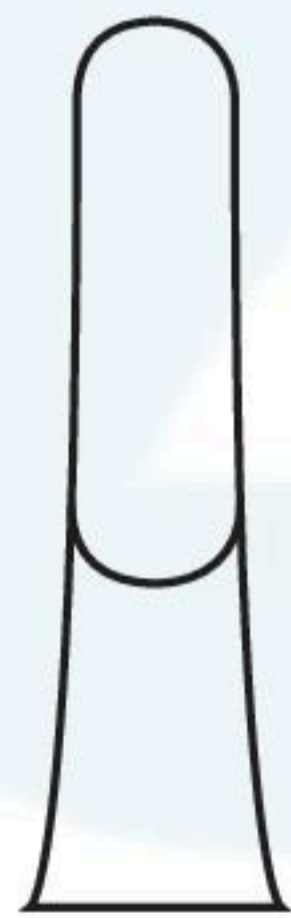

5mm

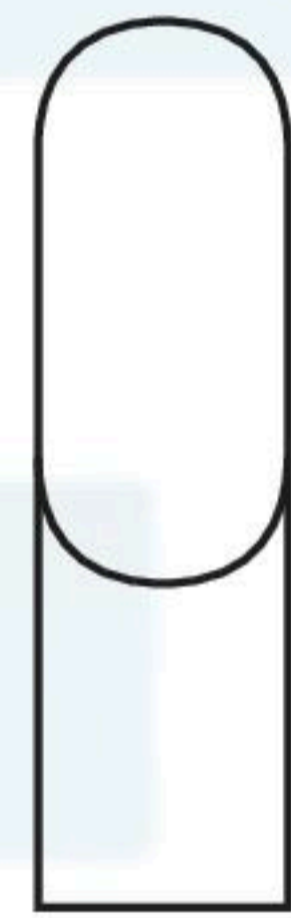

8mm



**'Mr Blobby' Stille-Luer Bone Nibbler**

Double Action  
26cm/10¼"

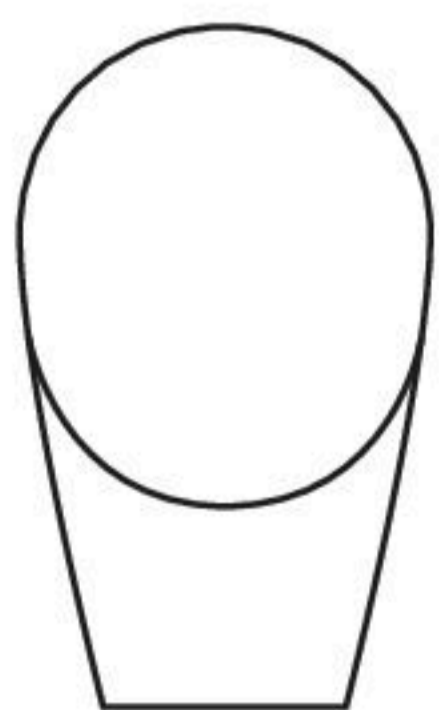

Straight  
17mm Bite

PS GT 1002-20

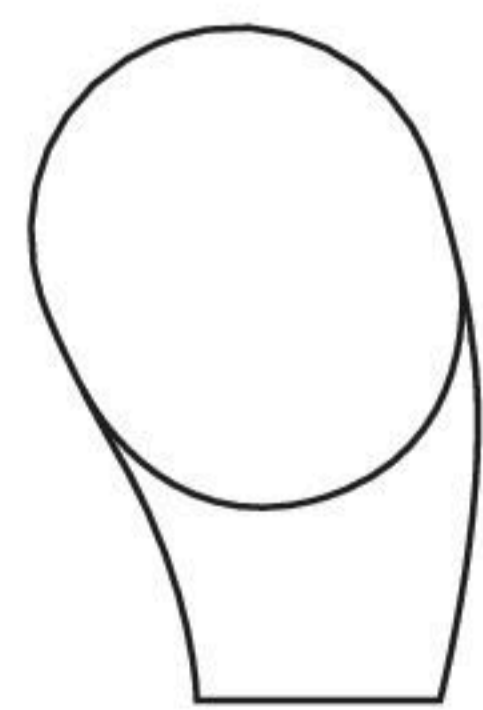

Curved  
17mm Bite

PS GT 1002-20



**SPINAL SURGERY**

**BONE NIBBLERS**

**Echlin Duckbill Nibbler**

Double Action  
23cm/9"

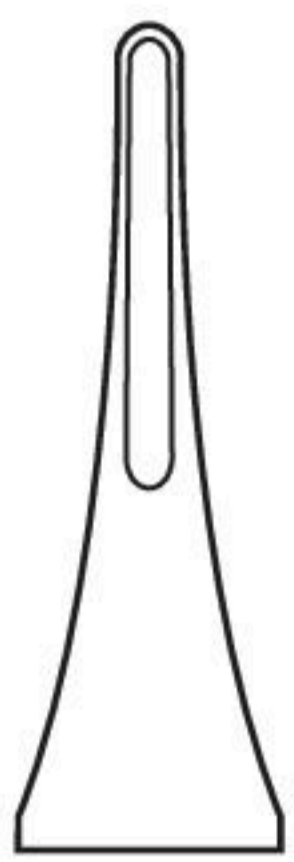

2mm Bite

PS GT 1044-23

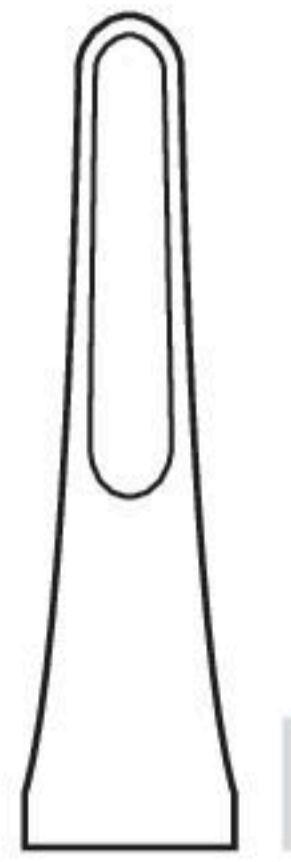

3mm Bite

PS GT 1045-23

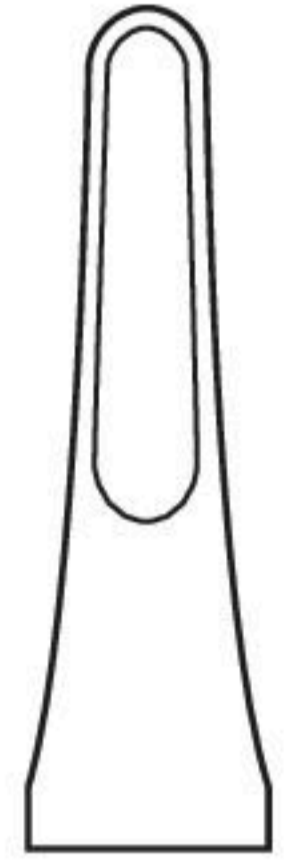

4mm Bite

PS GT 1046-23

**Long Anterior Leksell Bone Nibbler**

Double Action  
30cm/12"

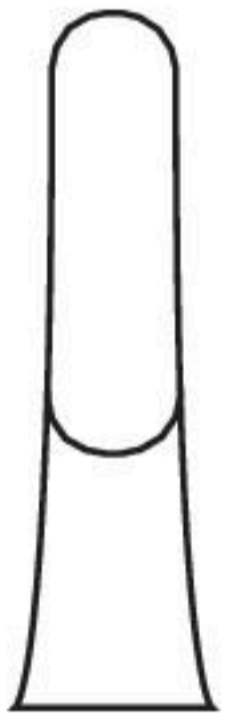

5mm Bite

PS GT 1021-30

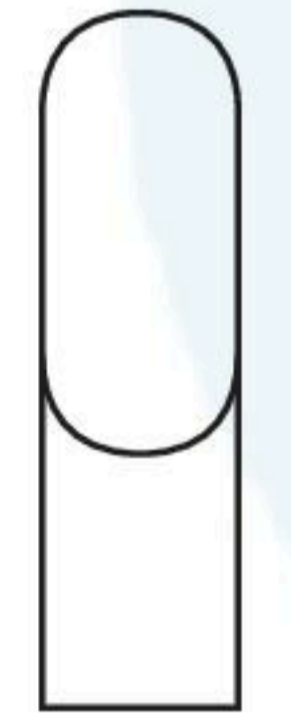

8 mm Bite

PS GT 1022-30

**Sypert Bone Nibbler**

Double Action - Very Long  
36cm/14 1/4"

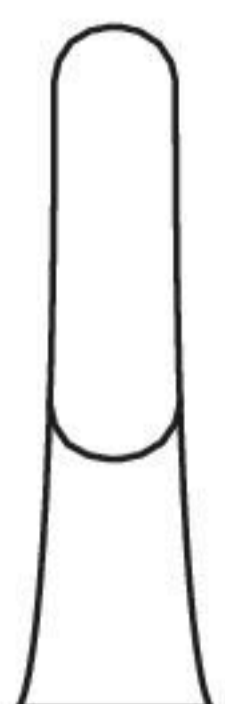

5mm Bite

PS GT 1031-36



8 mm Bite

PS GT 1032-36

**SPINAL SURGERY**

**BONE NIBBLERS**

**McIndoe Bone Cutters**

- 18cm/7"



PS GT 1028-18



**Stille-Liston Bone Cutters**

- 27cm/10 3/4"

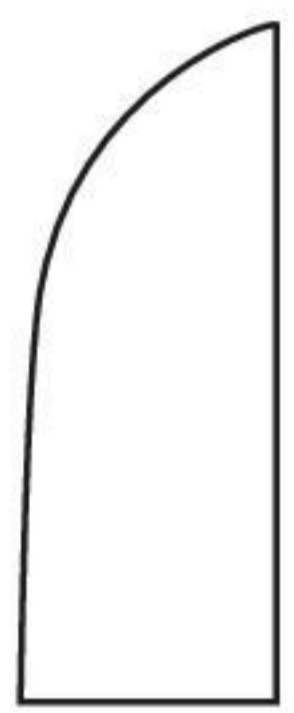

**Straight**

PS GT 1024-27



**Angled**

PS GT 1025-27



**Liston-Key-Horsley Bone Cutters**

- 27cm/10 3/4"



PS GT 1023-27



**Tudor Edwards/Vehmehren Costotome**

- 24cm/9 1/2"
- For cutting ribs

PS GT 1023-24

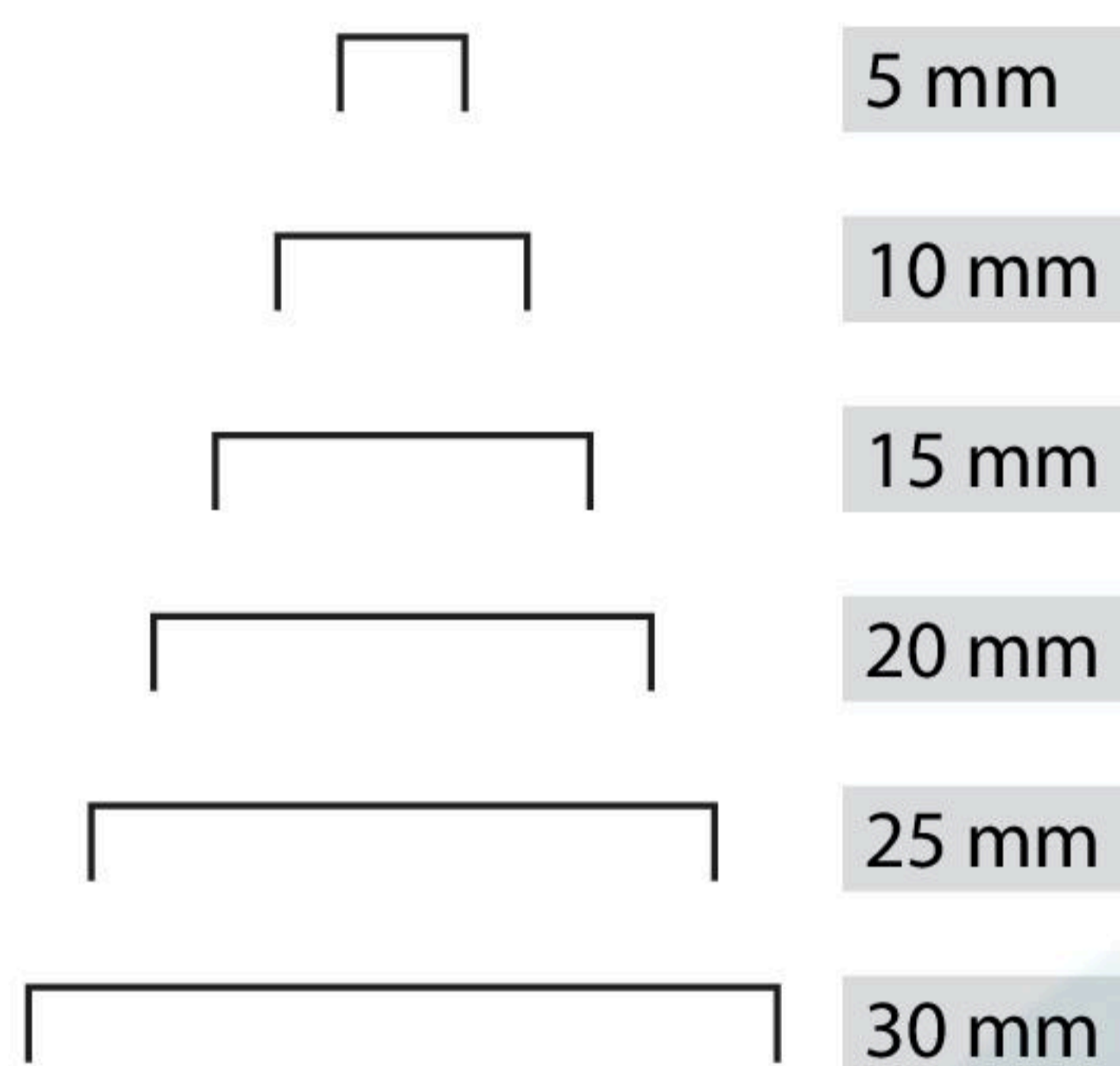

**SPINAL SURGERY**
**OSTEOTOMES**
**Dahmen Tufnol Handle  
Osteotome**

Straight	Width
PS GT 7105-30	5 mm
PS GT 7110-30	10 mm
PS GT 7115-30	15 mm
PS GT 7120-30	20 mm
PS GT 7125-30	25 mm
PS GT 7130-30	30 mm

Angled	Width
PS GT 7305-30	5 mm
PS GT 7310-30	10 mm
PS GT 7315-30	15 mm
PS GT 7320-30	20 mm
PS GT 7325-30	25 mm
PS GT 7330-30	30 mm

**Lexer Tufnol Handle Osteotome**

• 22cm/8 3/4"

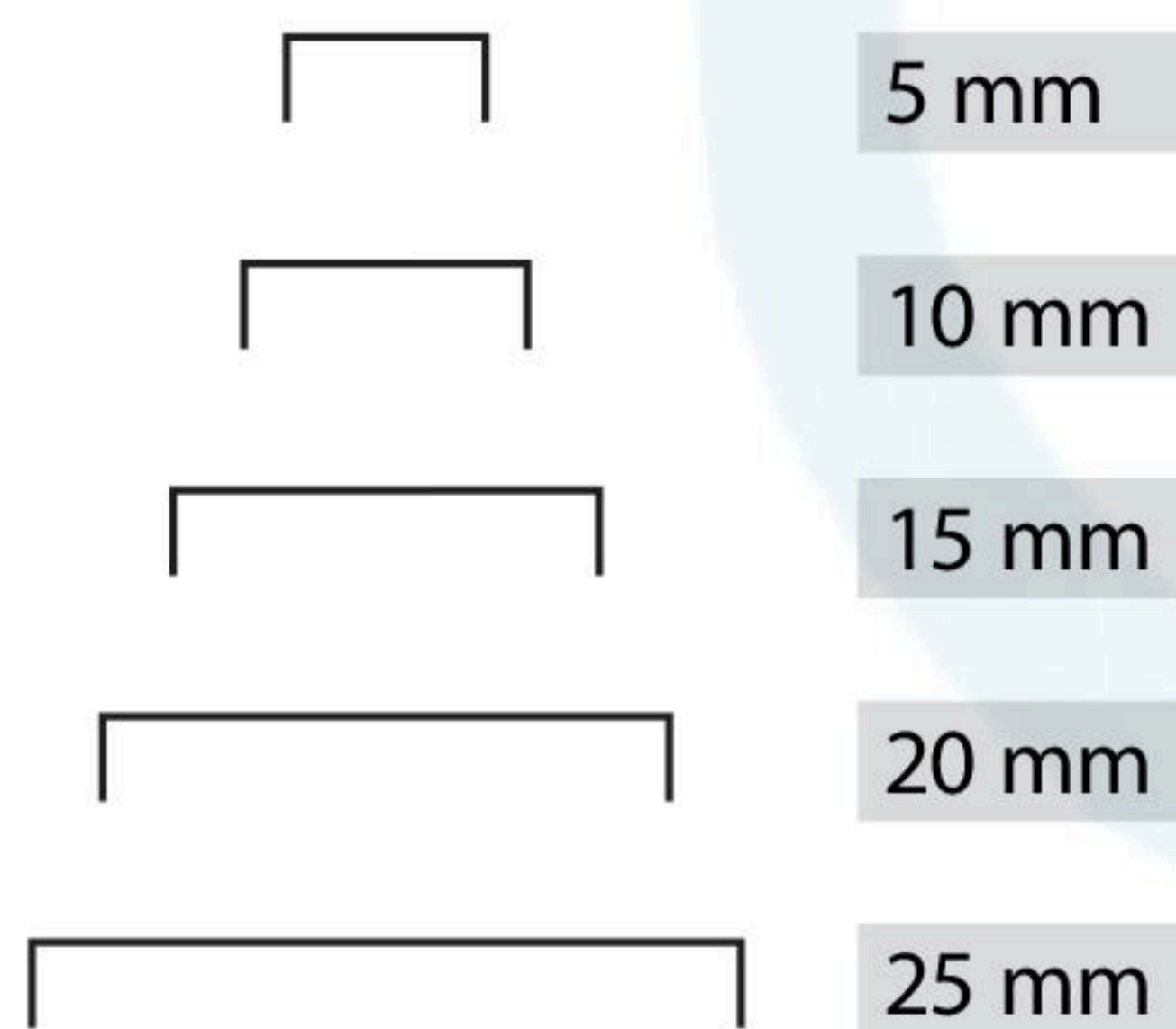

PS GT 7207-22	7 mm
PS GT 7210-22	10 mm
PS GT 7215-22	15 mm
PS GT 7220-22	20 mm
PS GT 7225-22	25 mm

**Stille Osteotome**

22cm/8 3/4"

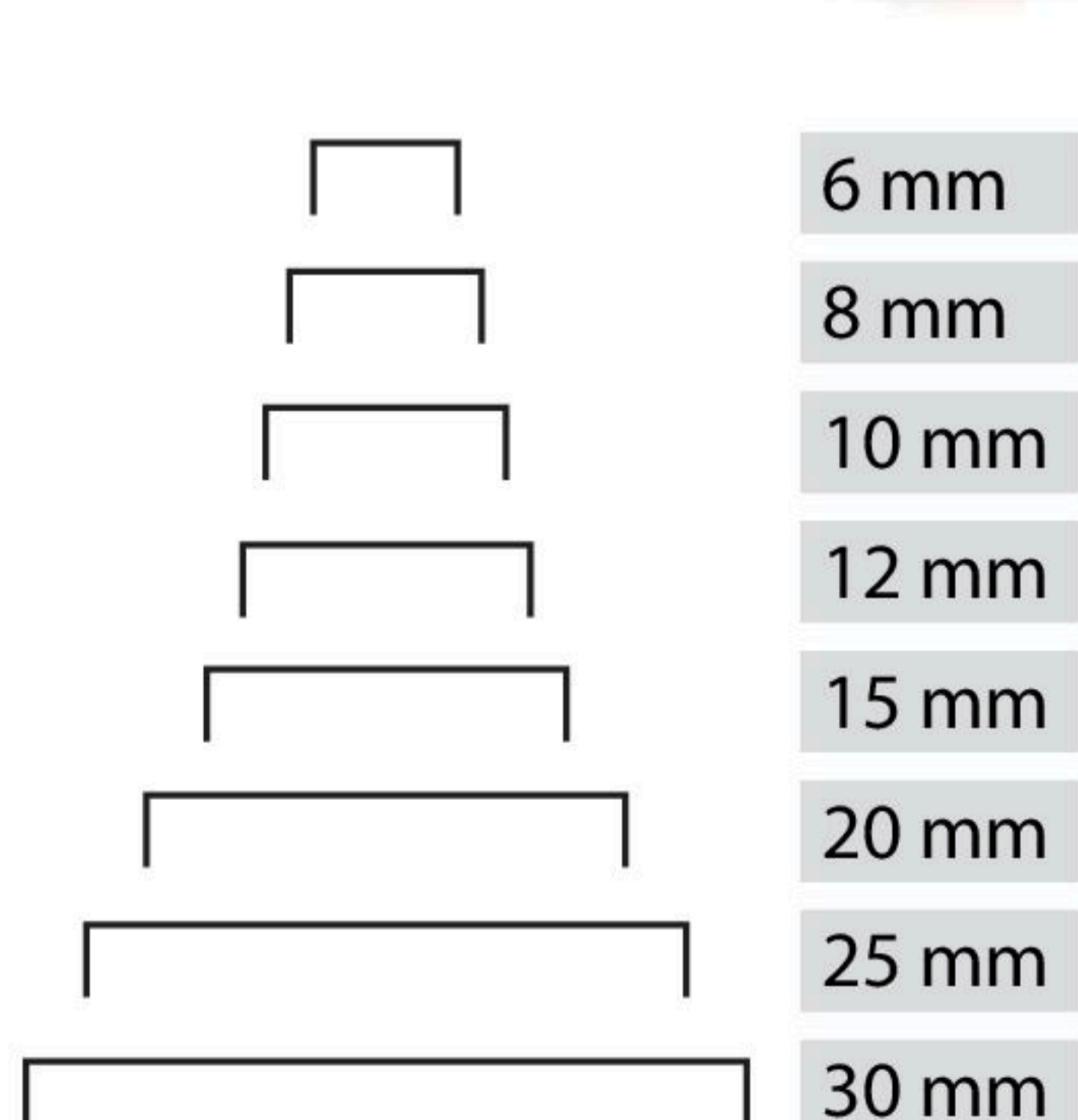
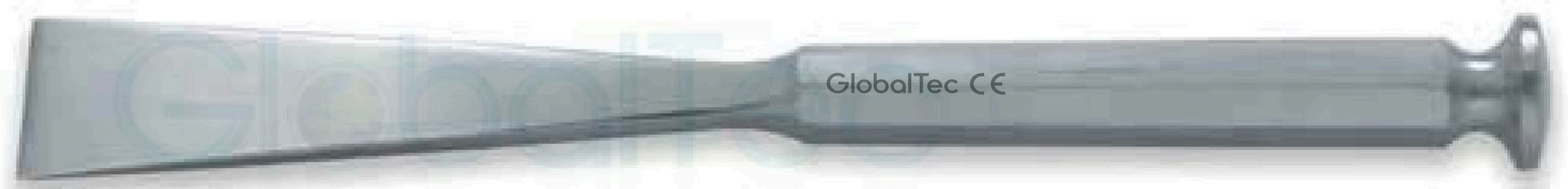

Width	
PS GT 7706-20	6 mm
PS GT 7708-20	8 mm
PS GT 7710-20	10 mm
PS GT 7712-20	12 mm
PS GT 7715-20	15 mm
PS GT 7720-20	20 mm
PS GT 7725-20	25 mm
PS GT 7730-20	30 mm

**SPINAL SURGERY**
**OSTEOTOMES & MALLETS**
**Scaglietti Straight  
Osteotome Set**

PS GT 7452-00

Complete set consisting of:



Qty	Order Code	Description
6 mm		Scaglietti Osteotomes - 5 sizes
8 mm	PS GT 7420-90	Instrument Case

**Scaglietti Osteotomes**

26cm/10 1/4"

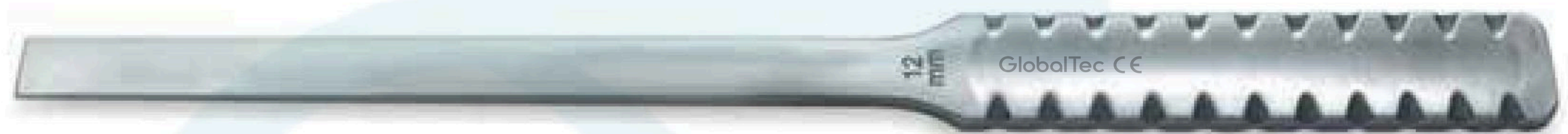

	Size
PS GT 7452-06	6 mm
PS GT 7452-09	9 mm
PS GT 7452-12	12 mm
PS GT 7452-16	16 mm
PS GT 7452-19	19 mm

**Toffee Mallet**

 19 cm/7 1/2"  
 Head size 22mm Ø  
 Weight 165g/6oz

PS GT 5802-18

**London Splint Mallet**

 18 cm/7"  
 Head size 30mm Ø  
 Weight 450g/16.2oz

PS GT 5802-18



**SPINAL SURGERY**

**MALLETS**

**Heath Mallet**

19 cm/7 ½"  
Stainless steel head  
Head size 40mm Ø  
Weight 1020g/36oz

PS GT 5809-19



**Mallet with Tufnol Handle**

23cm/9"  
Head size 35mm Ø  
Weight 550g/20oz

PS GT 5804-23



**Ombredanne Mallet**

24 cm/9 ½"  
Head size 40mm Ø  
Weight 550g/20oz

PS GT 5806-24



**Tufnol Mallet**

25.5cm/10"  
Head size 42mm Ø  
Weight 250g/10oz

PS GT 5807-25



**SPINAL SURGERY**
**ELEVATORS & GOUGES**
**Adson Periosteal Elevator**

- 16cm/6 ¼"
- Curved blunt



	Width
SP GT 3055-16	5 mm
SP GT 3007-16	7 mm

**Pennybacker Periosteal Elevator**

- 16cm/6 ¼"
- Curved sharp



	Width
PS GT3064-16	4 mm
SP GT 3066-16	6 mm
SP GT 3068-16	8 mm

**Bone Raspatory with Tufnol Handle**

- 19cm/7 ½"



	Width	Curved	Width
PS GT 7016 -19	6 mm	PS-GT 7023 -19	3 mm
		PS-GT 7026 -19	6 mm

**Farabeuf Rugine Elevator**

- 5cm/6"



	Width
PS GT 3001 -15	12 mm
PS GT 3002 -15	12 mm

\* illustrated

SPINAL SURGERY

ELEVATORS & GOUGES

Trethowan Bone Lever

- 22.5cm/8 1/2"



SP GT 3030-22

Lanes Bone Lever

- 26cm/10 1/4"



SP GT 3031-26

Fagge Bone Lever

- 7.5cm/10 3/4"



SP GT 3032-27

Bristows Bone Elevator

- 23cm/9"



Straight Width

SP GT 3003 -23 10 mm

**SPINAL SURGERY**
**ELEVATORS & GOUGES**
**Hohmanns Bone Elevator**

- 24cm/9 1/4"

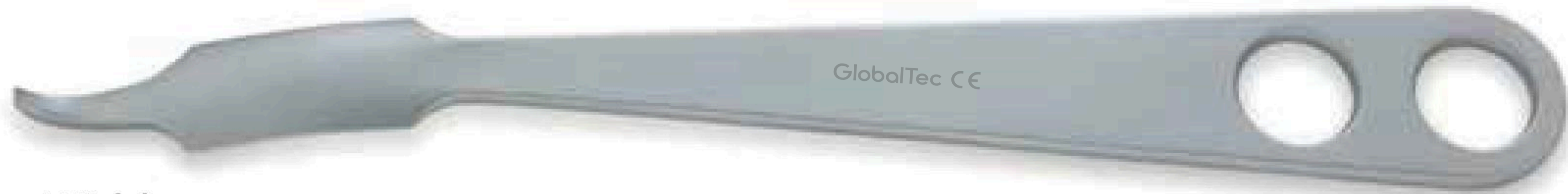
**Width**

PS GT 3008 -22	8 mm
PS GT 3018 -24	18 mm
PS GT 3043 -24	43 mm

**Inferior Hohmann Hip Retractor**

- 40cm/16"
- 22mm width

PS GT 3022-40

**Zielke Gouge**

- 23cm/9"

\*illustrated

**Curved\***      **Width**

PS GT 6520 - 23	6mm
PS GT 6521 - 23	9mm

**S-Shaped**      **Width**

PS-GT 6522 - 23	6mm
PS-GT 6531 - 23	9mm

**Capener Lamina Gouge**

- 23cm/9"
- Cranked Shaft

**Width**

PS GT 6506 - 23	6 mm
PS GT 6508 - 23	68 mm
PS GT 6511- 23	11 mm
PS GT 6516- 23	16 mm

**SPINAL SURGERY**

**BONE GRAFT IMPACTORS**

**Cervical Bone Graft Impactor 90° Offset**

22cm/8 1/2"

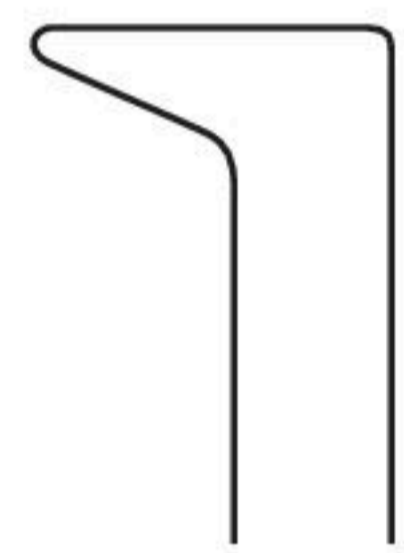
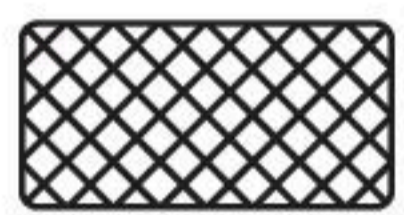

6mm x 12mm Tip

SP GT 222-10



3.5mm x 6mm Tip

SP GT 222-25

18cm length

**Lumbar Bone Graft Impactor**

22cm/8 1/2"

SP GT 3022-40

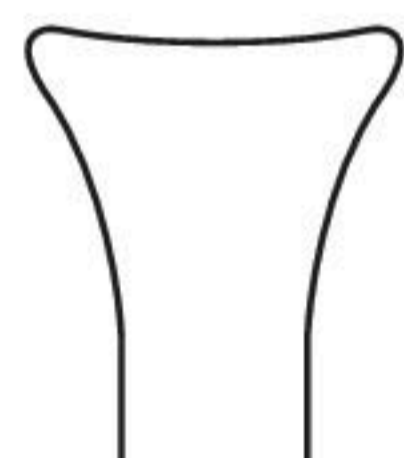
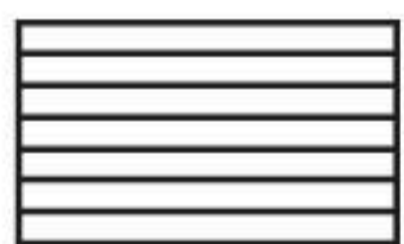
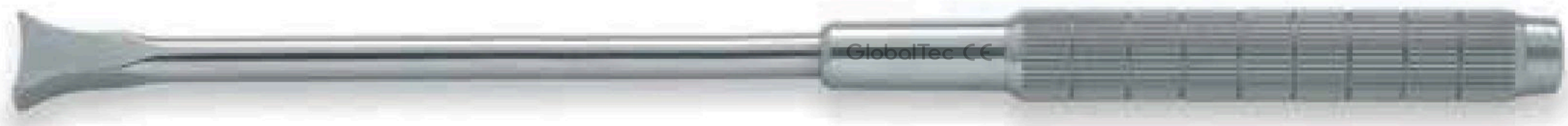

7mm x 12mm

SP GT 222-40

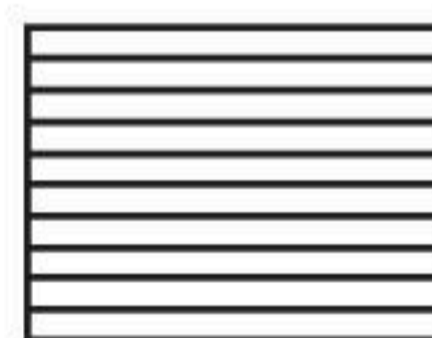

10mm x 13mm

SP GT 222-50

**Anterior Bone Graft Impactor**

34cm/13 1/2"

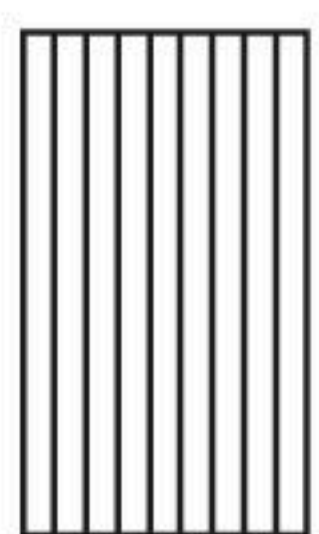

9 x 16mm Tip

SP GT 7439-48

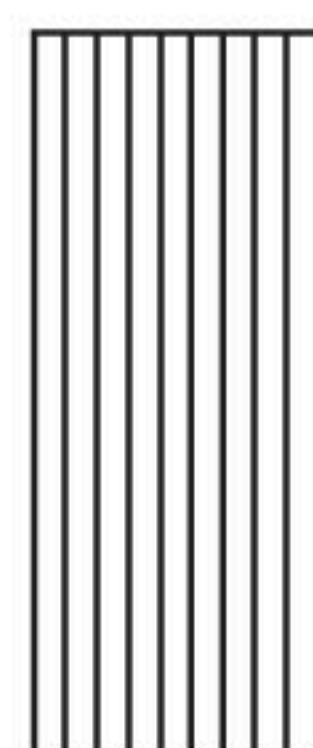

9 x 23mm Tip

SP GT 7439-50

**SPINAL SURGERY**
**COBB ELEVATORS**
**Cobb Spinal Elevator**

- 31cm/12 ¼" Overall length
- 18cm/7" Handle length



10 mm

PS GT 7561-10

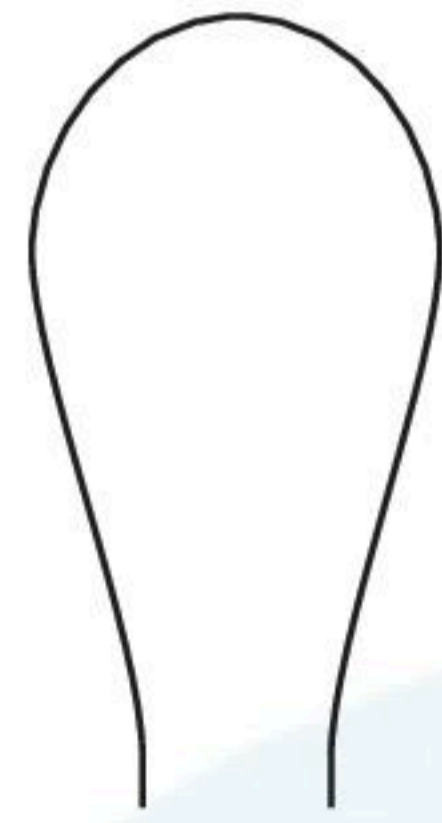

13 mm

PS GT 7561-13

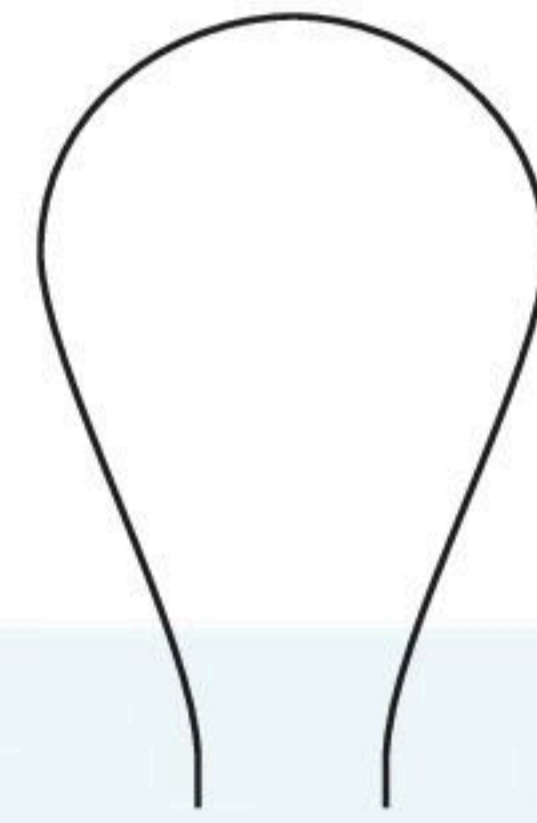

19 mm

PS GT 7561-19

**Harrington Cobb Spinal Elevator**

- 30.5cm/12" Overall length

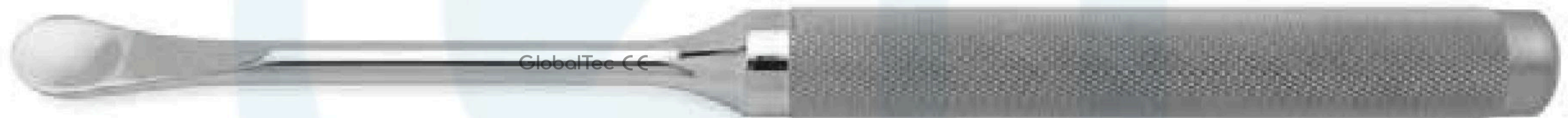

10 mm

PS GT 7661-10

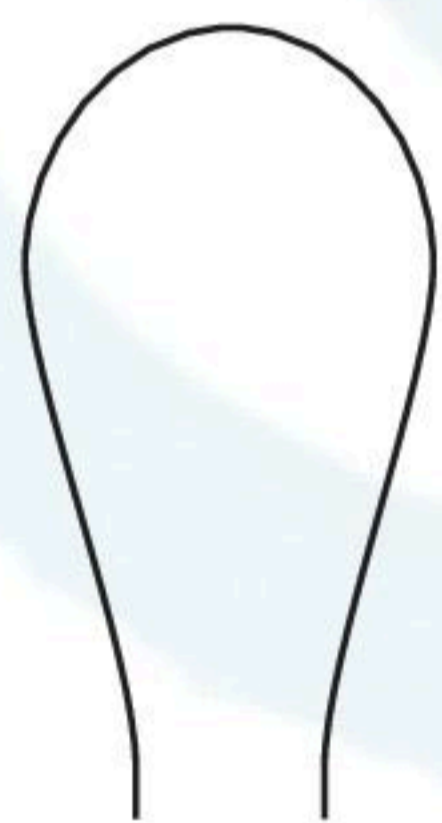

13 mm

PS GT 7661-13

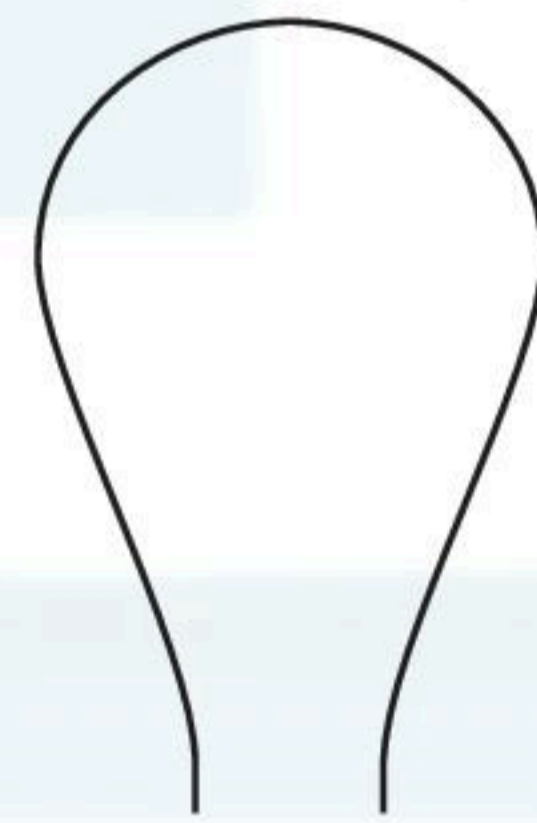

19 mm

PS GT 7661-19

**Cobb Spinal Elevator Extra Long Handle**

- 34cm/13 ½" Overall length
- 22cm/8 ¾" Handle length



10 mm

PS GT 7662-10



15 mm

PS GT 7662-15



20 mm

PS GT 7662-20



25 mm

PS GT 7662-25

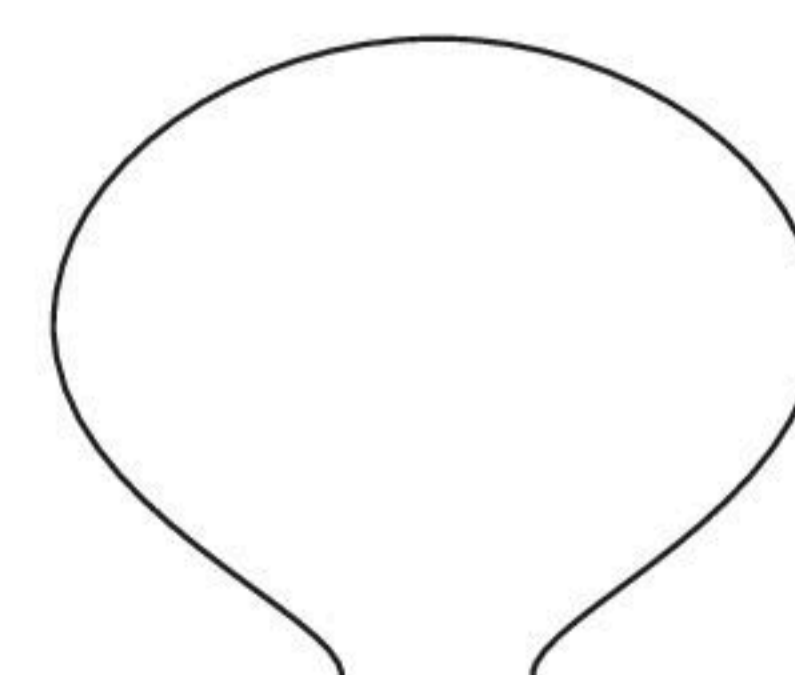

30 mm

PS GT 7662-30

**SPINAL SURGERY**
**COBB ELEVATORS**
**Comfort Cobb Elevator**

- 32cm/12 ½" Overall length
- 20cm/8" Handle length



10 mm

SP GT 7551-10

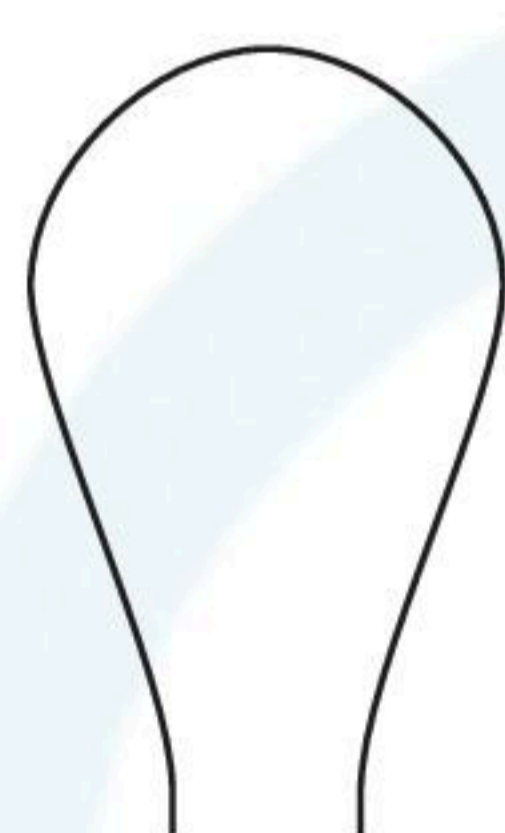

15 mm

SP GT 7551-15

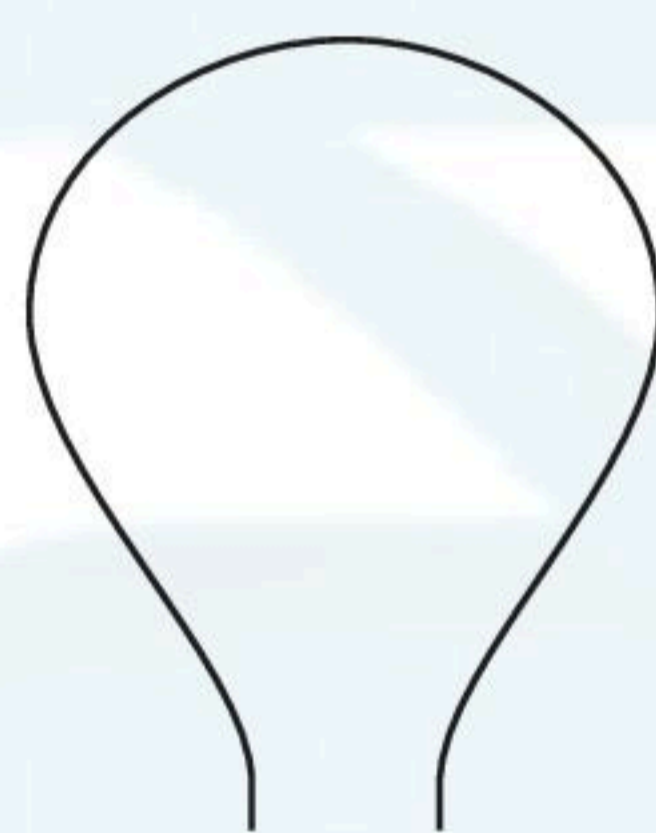

20 mm

SP GT 7551-20

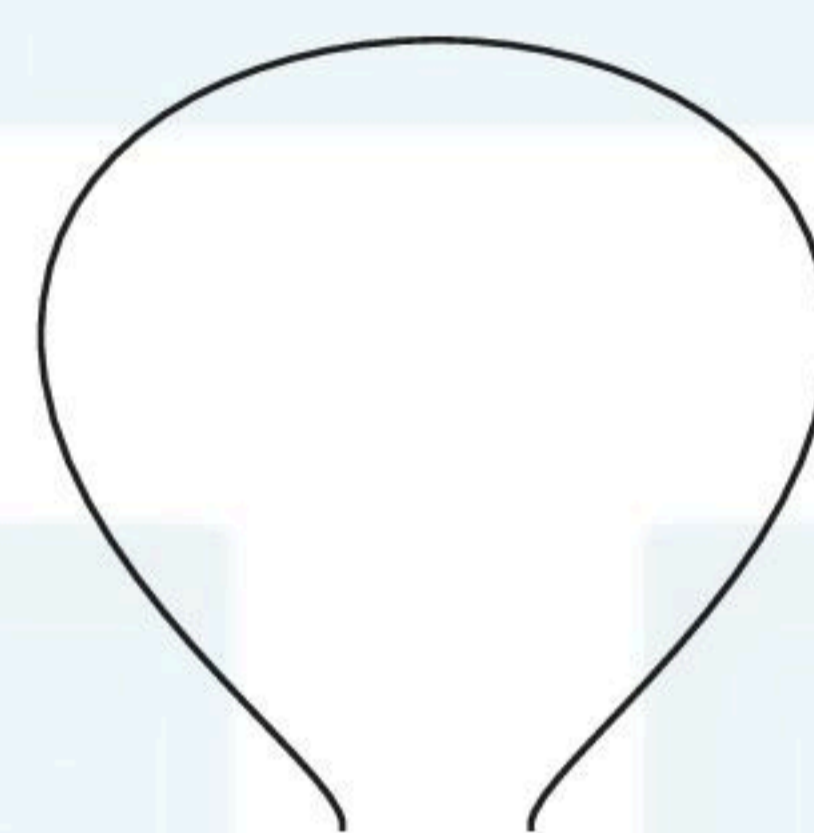

25 mm

SP GT 7551-25

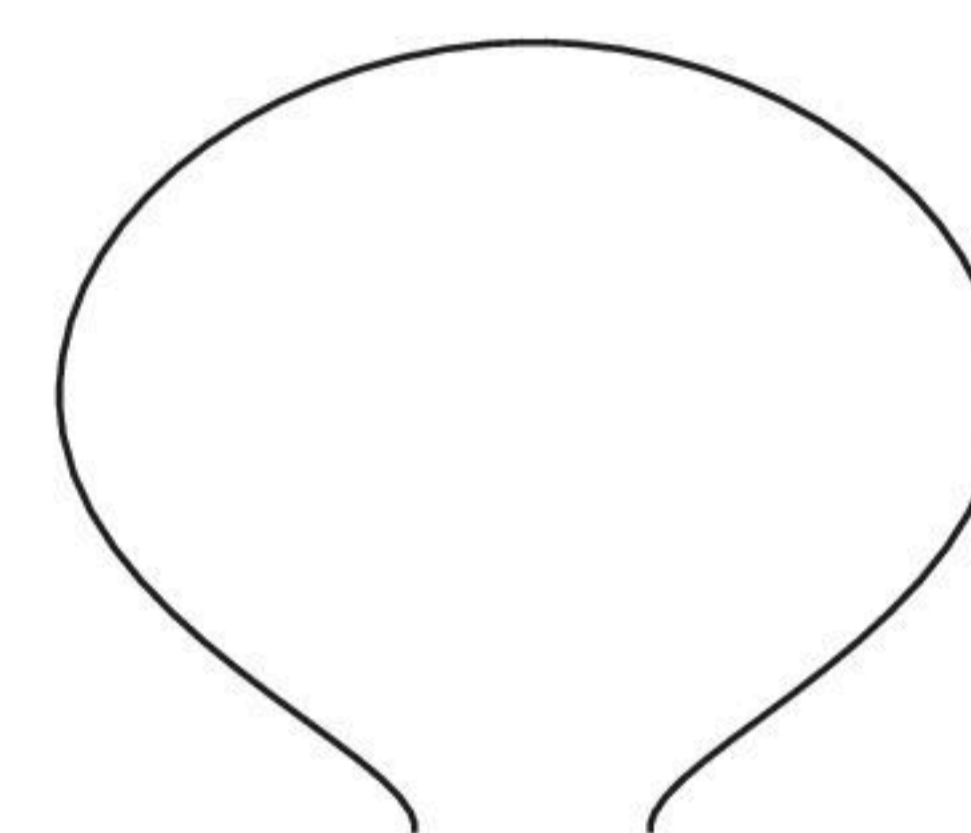

30 mm

SP GT 7551-30

**Long Anterior Comfort Cobb Elevator**

- 47cm/18 ½"

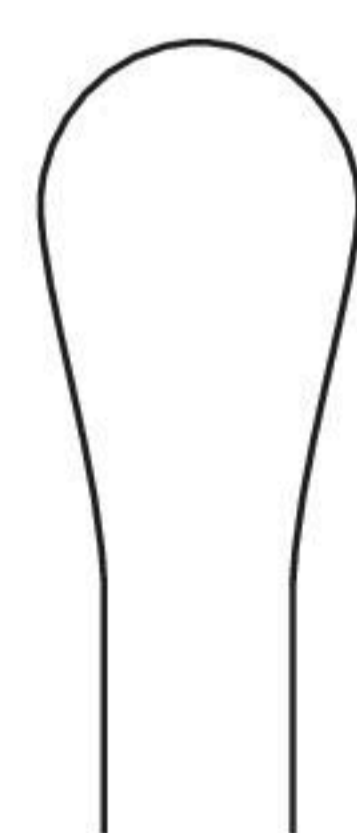

10 mm

SP GT 7551-50

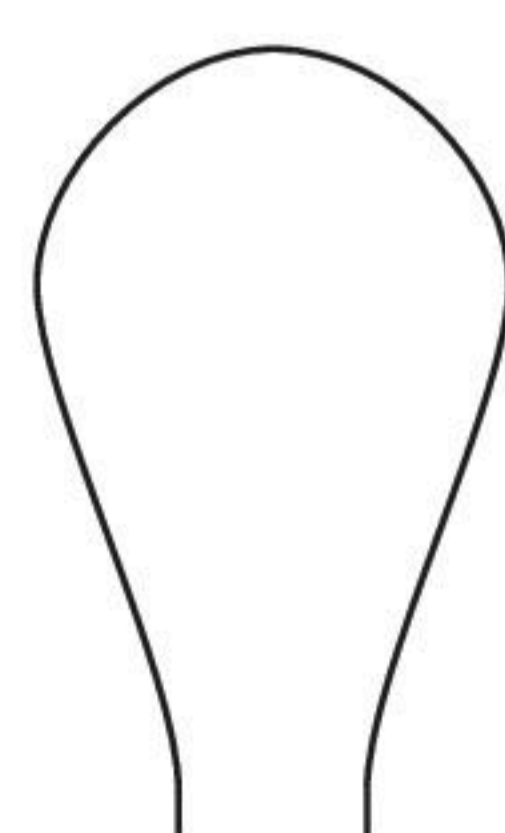

15 mm

SP GT 7551-55

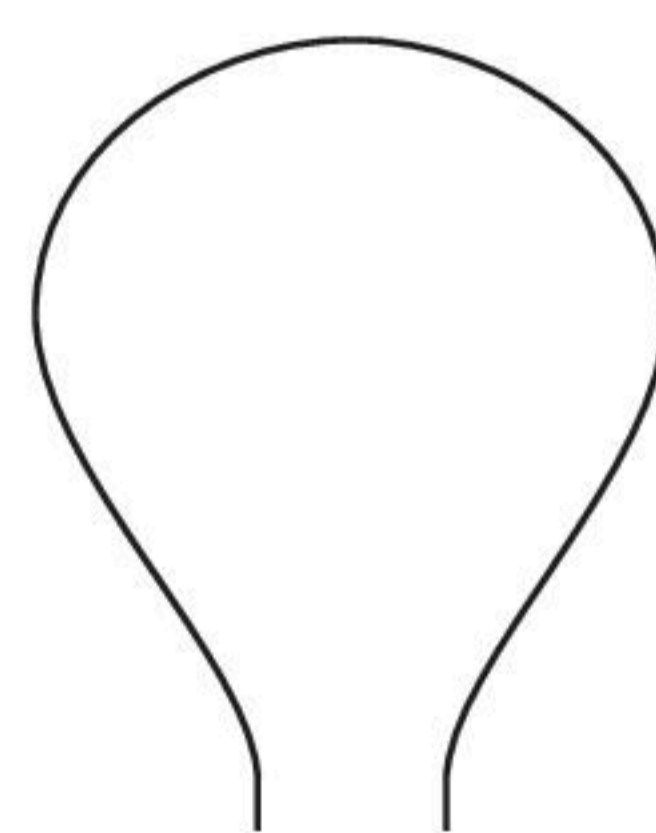

20 mm

SP GT 7551-60

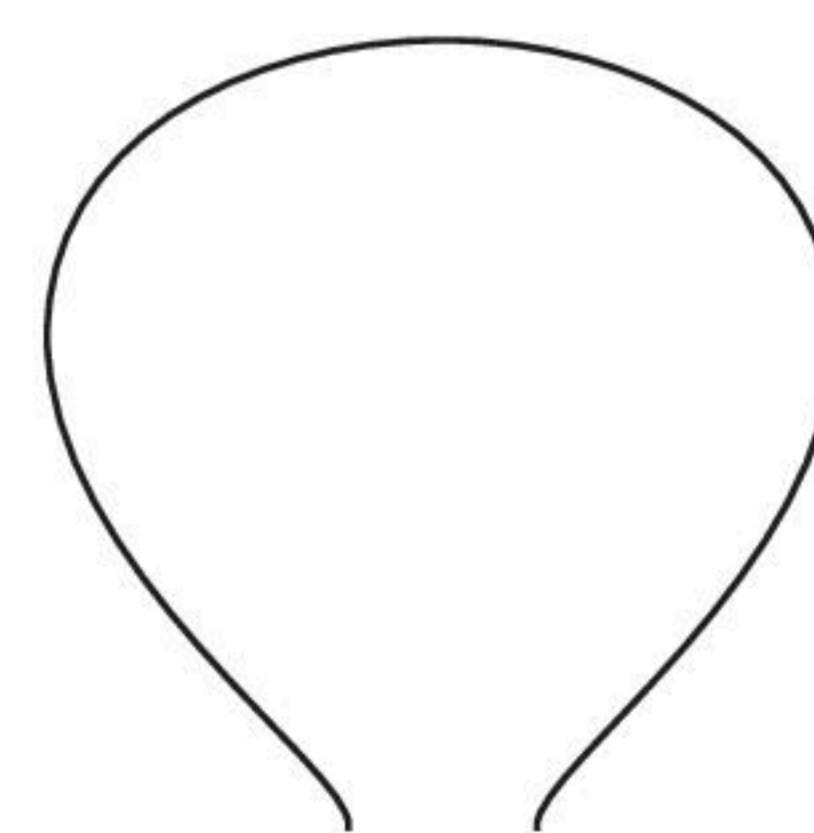

25 mm

SP GT 7551-65

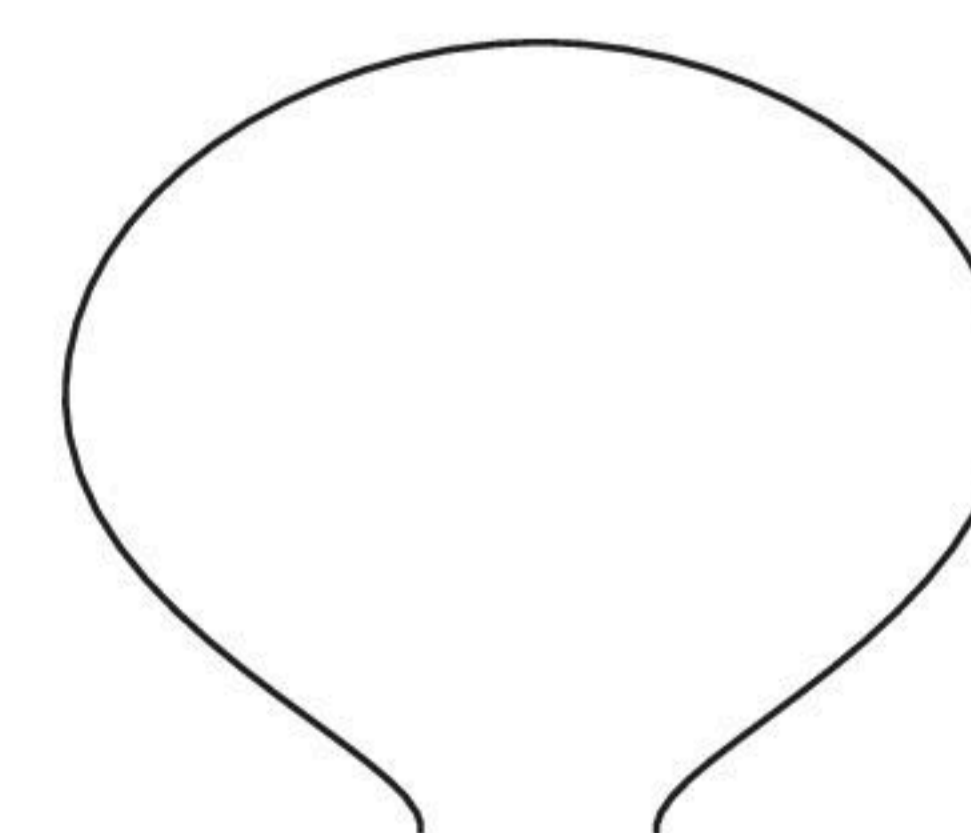

30 mm

SP GT 7551-70

**SPINAL SURGERY**
**BAYONET CERVICAL MICRO CURETTES**
**Cervical Micro Discectomy**

- Curette Set

**SP-GT 7420-00**

Complete set consisting of:

Qty	Order Code	Description
4	SP GT 7420-00	Curette Handles
12	SP GT 7420-00	Cervical Curette Shafts - includes: 5 Straight Shafts/5 Angled Shafts/2 Down Pushing Shafts
1	SP GT 7420-00	Cervical Curette Shafts - includes:

**Slim Micro Discectomy Curette Handle**
**SP-GT 7420-80**

- Bayonet handled design for improved visualisation
- 360° rotating shafts are interchangeable
- Shaft length is adjustable
- Lightweight handle
- Instrument length: 23cm max. for standard curettes
- Shaft length 10cm

0000	0000	0000	0000	1	4 mm	5 mm
Cup	Cup	Cup	Cup	Cup	Cup	Cup
Size	Size	Size	Size	Size	Size	Size

**Shaft Sizes**

Straight Cup	Cup size	Forward Angle	Cup size	Down Pushing	Cup size
SP GT 7420-50	00000	SP GT 7422-50	00000	SP GT 7424-20	00
SP GT 7420-40	00000	SP GT 7422-40	00000	SP GT 7424-10	00
SP GT 7420-30	000	SP GT 7422-30	000		
SP GT 7420-20	00	SP GT 7422-20	00		
SP GT 7420-10	0	SP GT 7422-10	0		

**SPINAL SURGERY**
**KARLIN STYLE BAYONET CERVICAL MICRO CURETTES**
**Bayonet Cervical Curette**

- 21.5cm/8 ½" overall length
- 9cm/3 ½" shaft length



Straight Cup	Forward Angle	Cup size				
PS GT 7418 - 10C	PS GT 7418 - 12C	0	0	0	0	0
PS GT 7418 - 20C	PS GT 7418 - 22C	00	0000	000	00	0
PS GT 7418 - 30C	PS GT 7418 - 32C	000	Cup	Cup	Cup	Cup
PS GT 7418 - 40C	PS GT 7418 - 42C	0000	Size	Size	Size	Size

**Long Bayonet Cervical Curette**

- 24cm/9 ½" overall length
- 12cm/4 ½" shaft length



Straight Cup	Forward Angle	Cup size				
PS GT 7418 - 10CL	PS GT 7418 - 12CL	0	0	0	0	0
PS GT 7418 - 20CL	PS GT 7418 - 22CL	00	0000	000	00	0
PS GT 7418 - 30CL	PS GT 7418 - 32CL	000	Cup	Cup	Cup	Cup
PS GT 7418 - 40CL	PS GT 7418 - 42CL	0000	Size	Size	Size	Size

**Container for 12 currettes**

PS GT 7418 - 98



**SPINAL SURGERY**
**SPINAL CURETTES**
**Lempert Curette**

• 21cm/8 1/4"

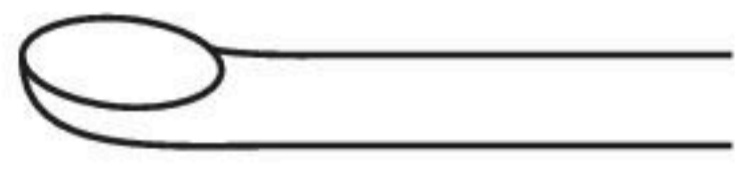

Straight Cup	Cup size	Straight Cup	Cup size
PS GT 8010 - 21	00000	PS GT 8110 - 21	00000
PS GT 8015 - 21	0000	PS GT 8115 - 21	0000
PS GT 8020 - 21	000	PS GT 8120 - 21	000
PS GT 8025 - 21	00	PS GT 8125 - 21	00
PS GT 8030 - 21	0	PS GT 8130 - 21	0
PS GT 8040 - 21	1	PS GT 8140 - 21	1

0000	0000	000	00	0	1 mm
Cup	Cup	Cup	Cup	Cup	Cup
Size	Size	Size	Size	Size	Size

**Bruns Curette**

• 23cm/9"

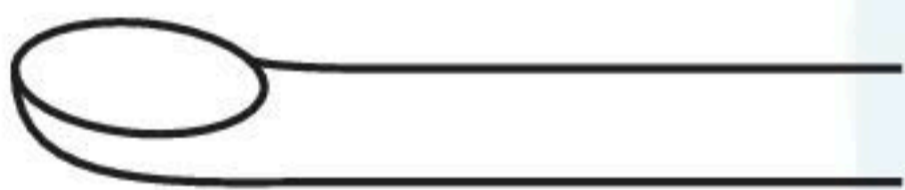

Straight Cup	Cup size	Straight Cup	Cup size
PS GT 8220 - 23	00000	PS GT 8320 - 23	00000
PS GT 8225 - 23	0000	PS GT 8325 - 23	0000
PS GT 8230 - 23	000	PS GT 8330 - 23	000
PS GT 8240 - 23	00	PS GT 8340 - 23	00
PS GT 8250 - 23	0	PS GT 8350 - 23	0
PS GT 8260 - 23	1	PS GT 8360 - 23	1

000	00	0	1	2	3
Cup	Cup	Cup	Cup	Cup	Cup
Size	Size	Size	Size	Size	Size

**Tufnol Handle Micro Curette**

• 27cm/10"

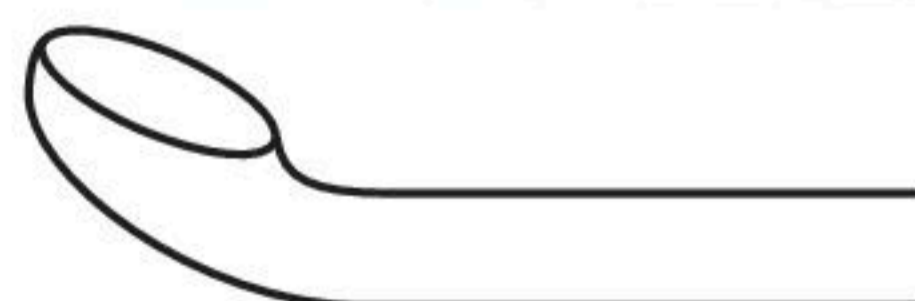
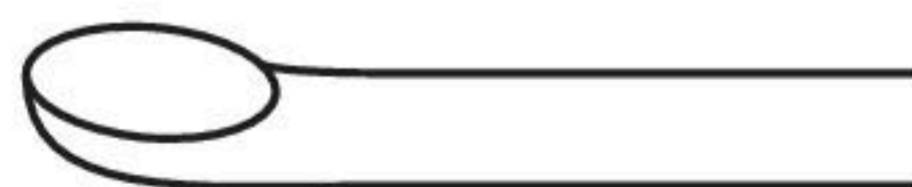

Straight Cup	Cup size	Straight Cup	Cup size
PS GT 8010 - 27	00000	PS GT 8110 - 27	0000
PS GT 8020 - 27	0000	PS GT 8120 - 27	000
PS GT 8030 - 27	000	PS GT 8130 - 27	00
PS GT 8040 - 27	00	PS GT 8140 - 27	0
PS GT 8050 - 27	0	PS GT 8150 - 27	1

0000	000	00	0	1
Cup	Cup	Cup	Cup	Cup
Size	Size	Size	Size	Size

## SPINAL SURGERY

### Double Handled Extra Large Curette

- 38cm/15" Overall length
- 21cm/8 3/4" Handle length

### SPINAL CURETTES



Straight	Cup size	Angled	Cup size
PS GT 8807- 34	7mm	PS GT 8907- 34	7mm
PS GT 8809- 34	9 mm	PS GT 8909- 34	9 mm
PS GT 8811- 34	11 mm	PS GT 8911- 34	11 mm
PS GT 8813- 34	13 mm	PS GT 8913- 34	13 mm
PS GT 8815- 34	15 mm	PS GT 8915- 34	15 mm

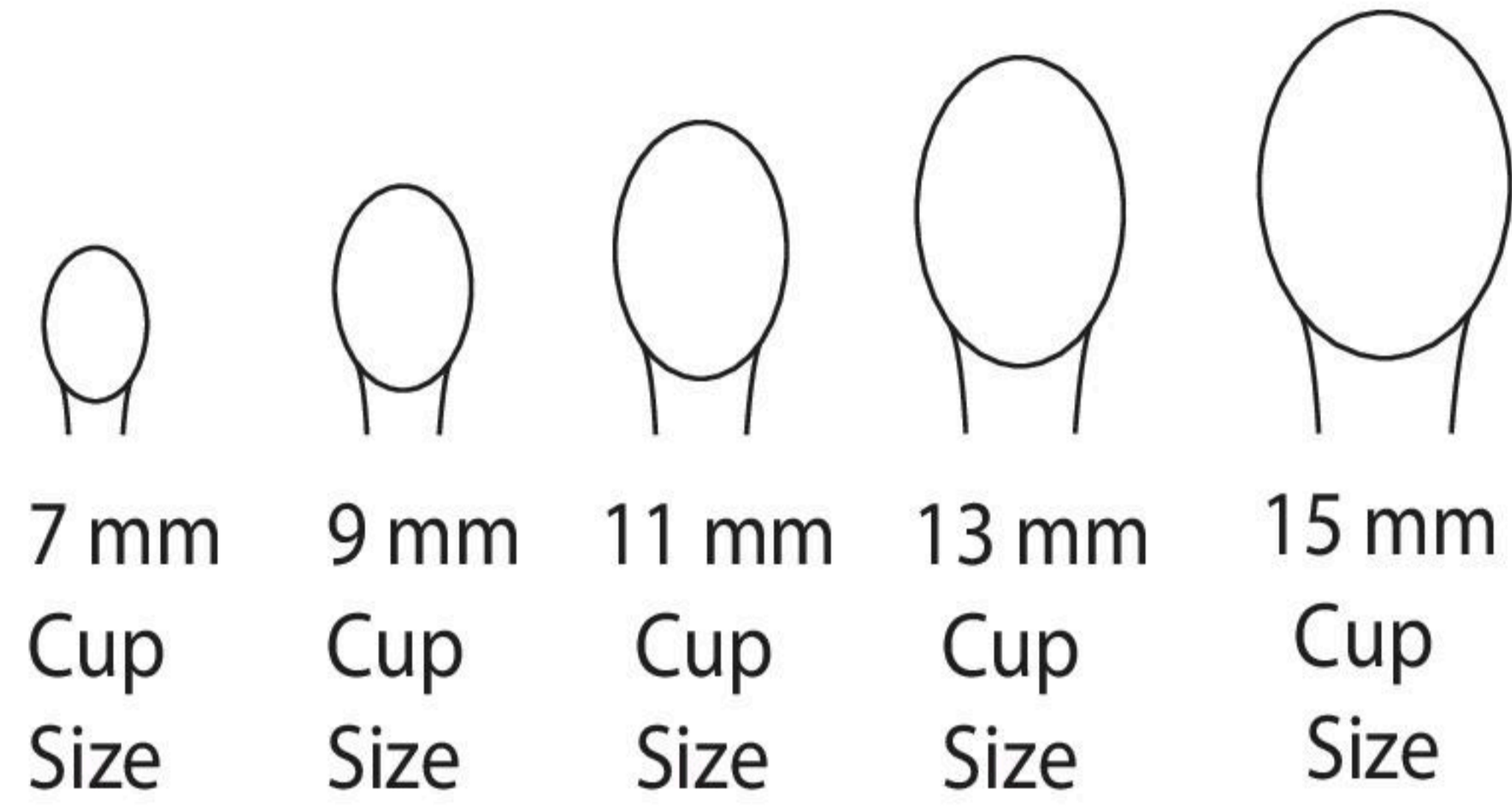

### Comfort Handle Curette

- 29cm/11 1/2" overall length
- 20cm handle length



Straight	Cup size	Angled	Cup size
PS GT 7561-07	6.5mm	PS GT 8907- 34	6.5mm
PS GT 7561-09	8.5 mm	PS GT 8909- 34	8.5 mm
PS GT 7561-11	11 mm	PS GT 8911- 34	11 mm
PS GT 7561-13	13 mm	PS GT 8913- 34	13 mm
PS GT 7561-15	15 mm	PS GT 8915- 34	15 mm

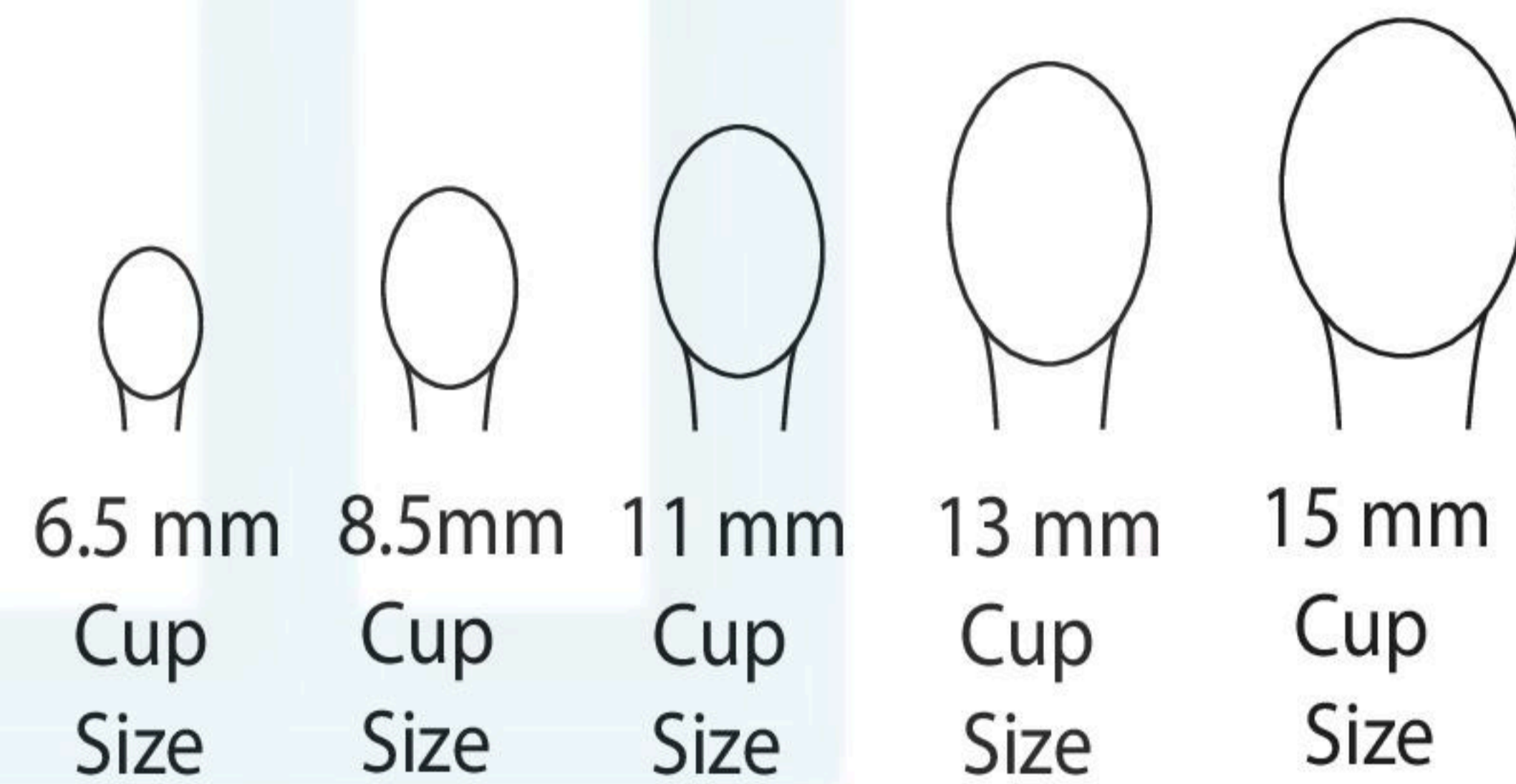

### Long Anterior Curette

- 38cm/15" overall length



Straight	Cup size	Angled	Cup size
PS GT 8043 - 38	4.3mm	PS GT 8143- 38	4.3mm
PS GT 8070 - 38	7 mm	PS GT 8170-38	7 mm
PS GT 8080 - 38	8 mm	PS GT 8180 - 38	8 mm

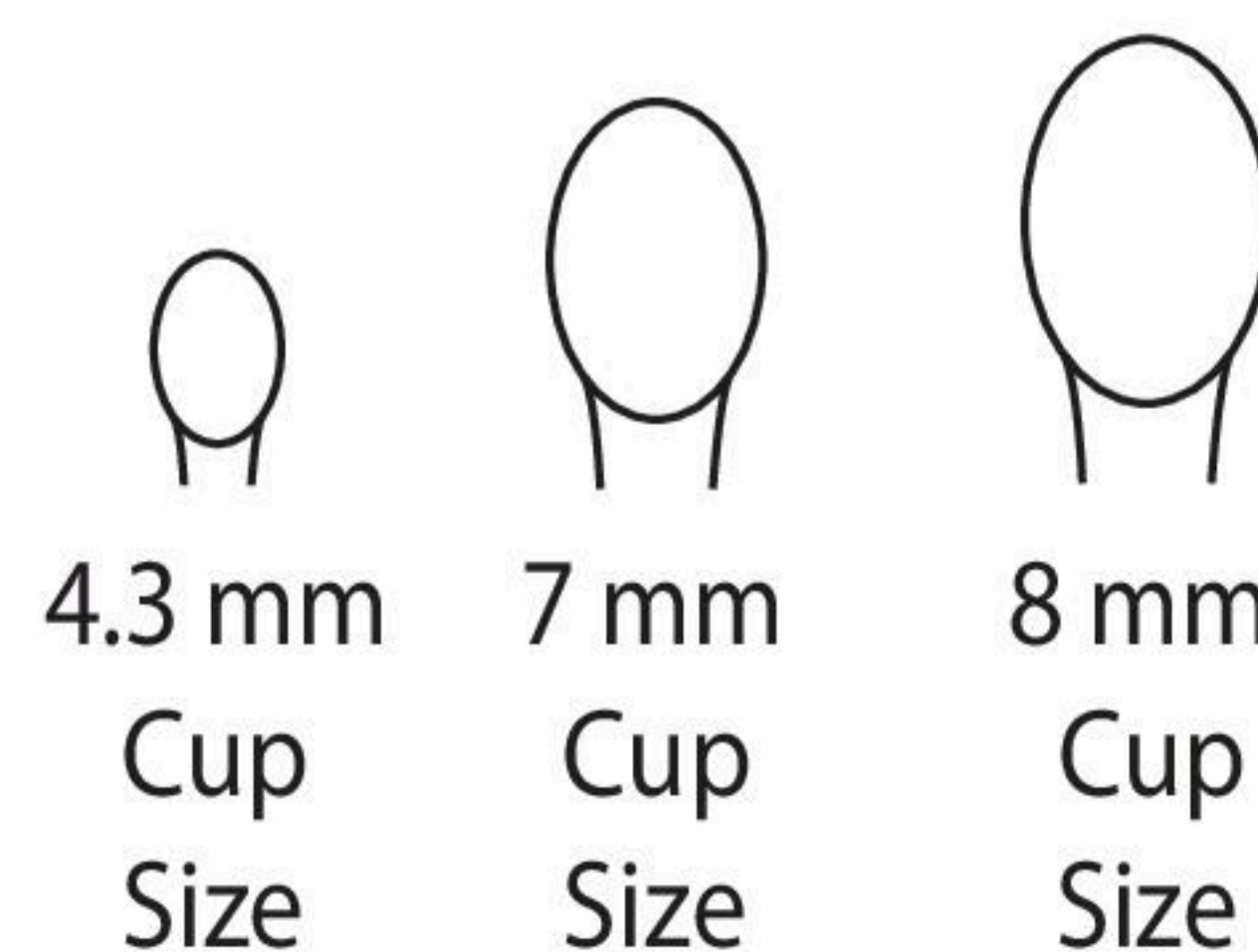

SPINAL SURGERY

**SPINAL CURETTES**

Light-Grip Cervical Curettes

- 26cm/10 ¼" overall length
- 13cm/5 ¼" handle length
- Colour coded handles

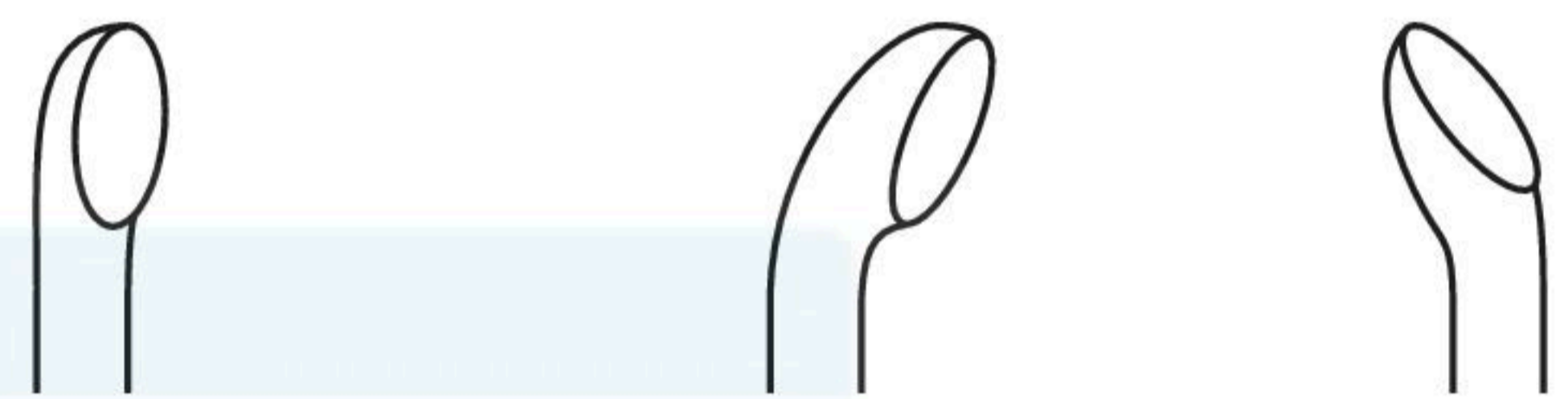

Cup Size	Straight	Forward	Down
6-0	PS GT 7403-06	PS GT 7405-06	PS GT 7406-06
5-0	PS GT 7403-05	PS GT 7405-05	PS GT 7406-05
4-0	PS GT 7403-04	PS GT 7405-04	PS GT 7406-04
3-0	PS GT 7403-03	PS GT 7405-03	PS GT 7406-03
2-0	PS GT 7403-02	PS GT 7405-02	PS GT 7406-02
0	PS GT 7403-01	PS GT 7405-01	PS GT 7406-01
1	PS GT 7403-10	PS GT 7405-10	PS GT 7406-10
2	PS GT 7403-20	PS GT 7405-20	PS GT 7406-20
3	PS GT 7403-30	PS GT 7405-30	PS GT 7406-30
4	PS GT 7403-40	PS GT 7405-40	PS GT 7406-40
5	PS GT 7403-50	PS GT 7405-50	PS GT 7406-50
6	PS GT 7403-60	PS GT 7405-60	PS GT 7406-60

Light-Grip Cervical Curette Rack  
Holds 12 Cervical Curettes

PS GT 7404-90

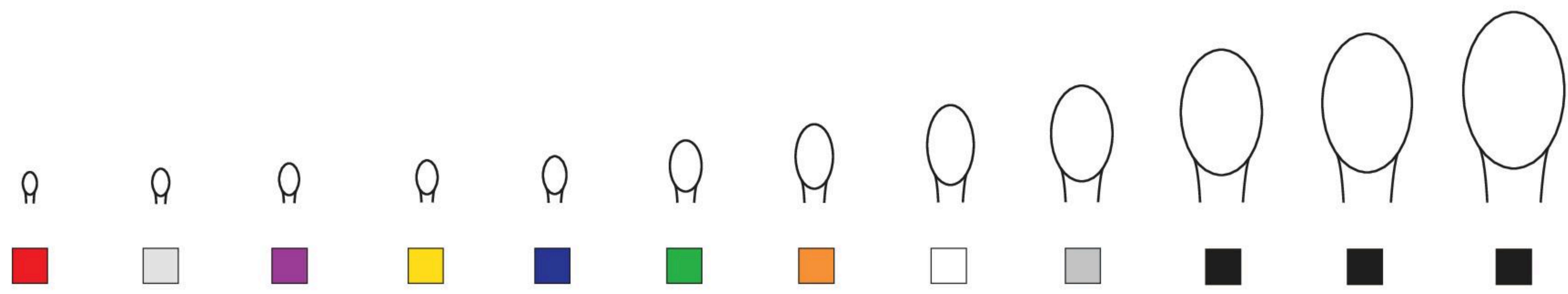

SPINAL SURGERY

Light-Grip Lumbar Currettes

- 34cm/13 1/2" overall length
- 20cm/8" handle length
- Colour coded handles

**SPINAL CURETTES**



Cup Size	Straight	Forward	Down
6-0	PS GT 7407-06	PS GT 7408-06	PS GT 7409-06
5-0	PS GT 7407-05	PS GT 7408-05	PS GT 7409-05
4-0	PS GT 7407-04	PS GT 7408-04	PS GT 7409-04
3-0	PS GT 7407-03	PS GT 7408-03	PS GT 7409-03
2-0	PS GT 7407-02	PS GT 7408-02	PS GT 7409-02
0	PS GT 7407-01	PS GT 7408-01	PS GT 7409-01
1	PS GT 7407-10	PS GT 7408-10	PS GT 7409-10
2	PS GT 7407-20	PS GT 7408-20	PS GT 7409-20
3	PS GT 7407-30	PS GT 7408-30	PS GT 7409-30
4	PS GT 7407-40	PS GT 7408-40	PS GT 7409-40
5	PS GT 7407-50	PS GT 7408-50	PS GT 7409-50
6	PS GT 7407-60	PS GT 7408-60	PS GT 7409-60

Light-Grip Lumbar Curette Rack Holds 12 Lumbar Currettes

PS GT 7407-90

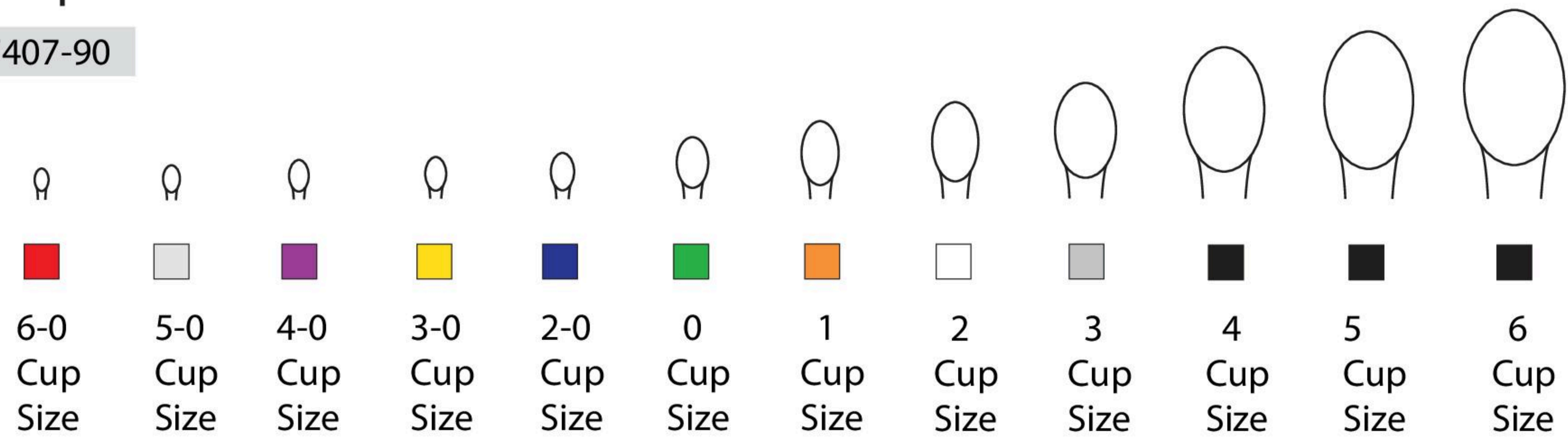

**SPINAL SURGERY**

**SPINAL CURETTES**

**Cones Ring Curette**

• 23cm/9"

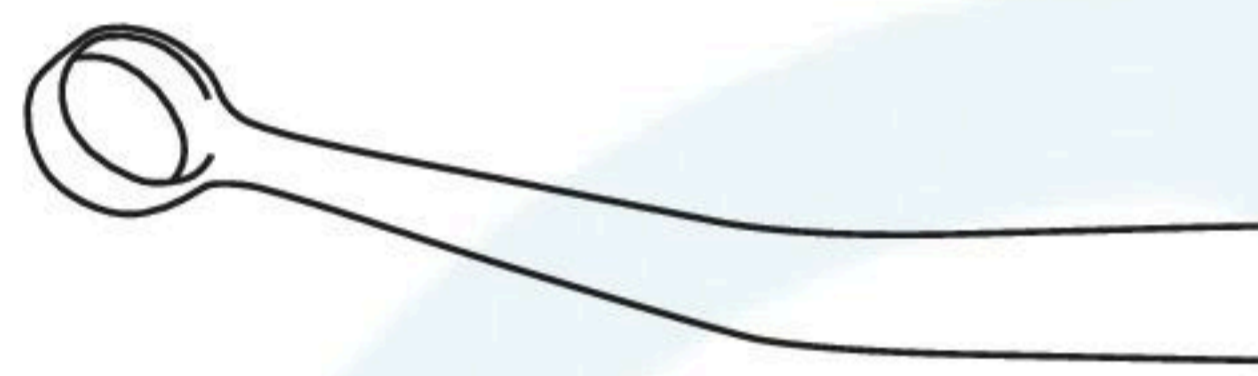

Straight	Ring Size	Angled	Ring Size	
PS GT 8803 - 23	3mm	PS GT 8903 - 23	3mm	○ 3mm ring size
PS GT 8806 - 23	6mm	PS GT 8906 - 23	6mm	○ 6mm ring size
PS GT 8806 - 23	8mm	PS GT 8906 - 23	8mm	○ 8mm ring size

**Zielke Curette**

• 21cm/8¼"



Straight	Size	Angled	Size
PS GT 8608 - 21	3mm	PS GT 8708 - 21	3mm
PS GT 8608 - 21	11mm	PS GT 8708 - 21	11mm

**Volkman Double Ended Curette**

• 22cm/8¾"



Straight	Size			
PS GT 8401-22	Small	○	○	○
PS GT 8401-22	Medium	○	○	○
PS GT 8401-22	Large	○	○	○
		Small	Medium	Large

**SPINAL SURGERY**
**DISSECTORS**
**Swedish Dissector**

- 8cm/7"



PS GT 9201 -18

**Howarth Elevator**

- 21.5cm/8 ½"



PS GT 9207-21

**MacDonald Elevator/Dissector**



Size

PS GT 9207-21 18cm/7"

PS GT 9207-21 23cm/9"

**Watson Cheyne Dissector**

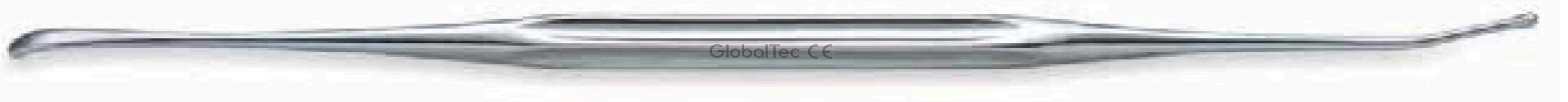
- 22cm/8¾"



Size

PS GT 7203 -18 18cm/7"

PS GT 9203 - 23 23cm/9"

PS GT 9203 - 25 25.5cm/10"

**Freers Elevator/Dissector**

- 18.5cm/7 ¼"

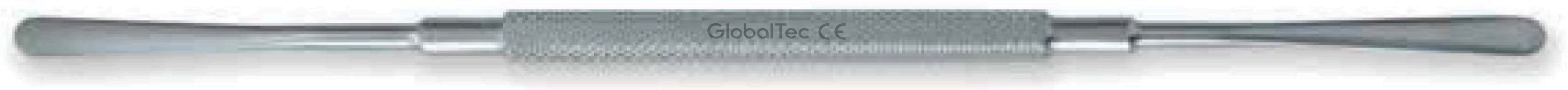

PS GT 7602 -18

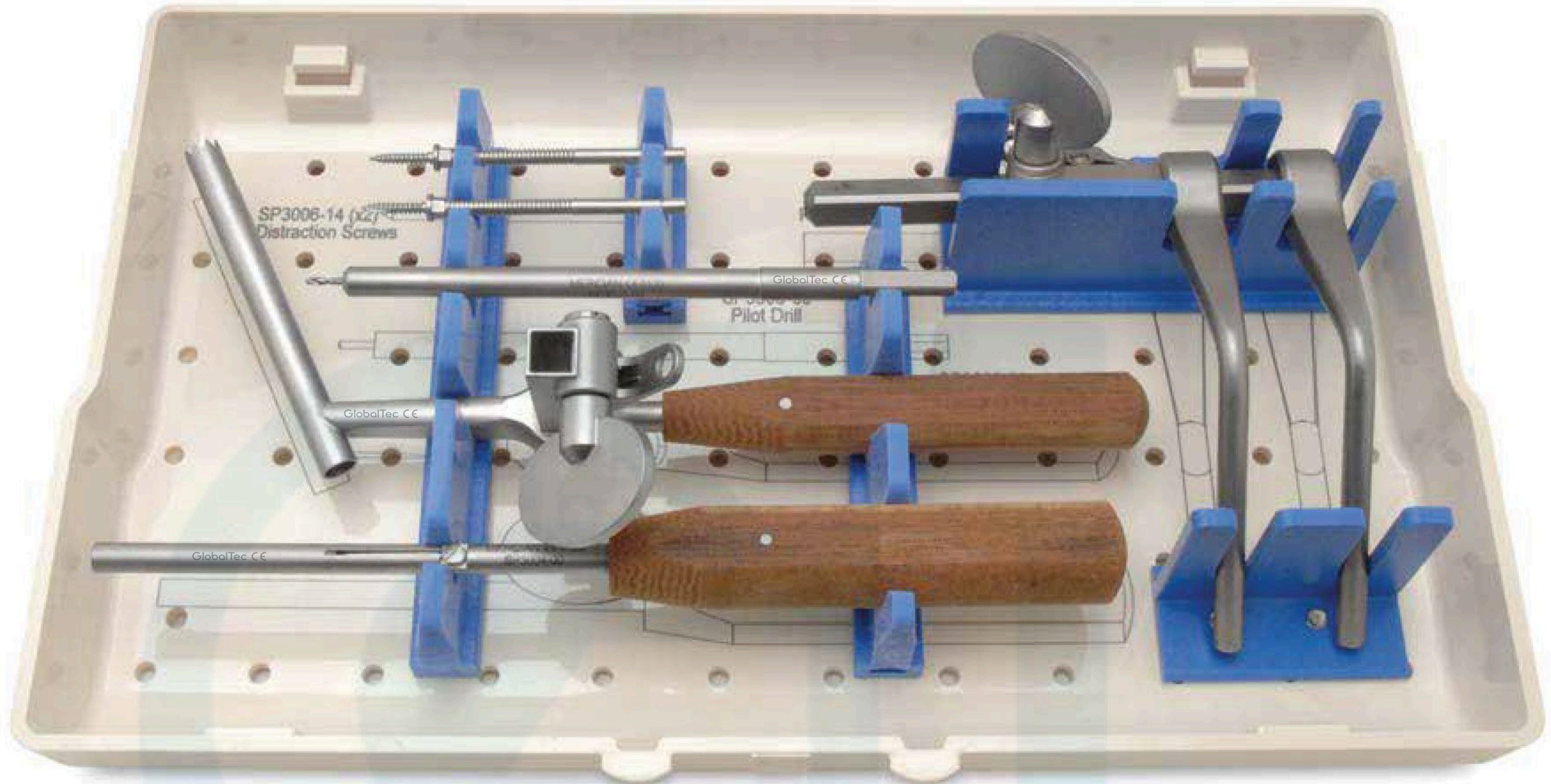
**SPINAL SURGERY**
**CASPAR CERVICAL DISTRACTION SET**
**Caspar Vertebral Body Distraction Set**

**SP-GT 3001-00**

- For retraction of the vertebral body in the cervical spine to allow access to the disc
- Less instrumentation in the disc space..
- Distraction screws are secured into the vertebral body either side of the disc, the retractor is then slid over the screws and retracted.

**Complete set consisting of:**

Qty	Order Code	Description
1	PS GT 3002-00	Retractor Right
1	PS GT 3003-00	Drill Guide Right
1	PS GT 3004-00	Screw Driver
1	PS GT 3005-00	Distraction Drill
1	PS GT 3006-14	Sterile Distraction Screws 14mm

**Distraction Retractor**

PS GT3002 - 00 Right (illustrated)

PS GT 3002 - 10 Left



**SPINAL SURGERY**
**CASPAR CERVICAL DISTRACTION SET**
**Drill Guide**

PS GT 3003 - 00 Right (illustrated)

PS GT 3003 - 10 Left

**Screw Driver**

PS GT 3004 - 00



**Distraction Drill**

PS GT 3005 - 00

- For pre-drilling pilot holes for screws with drill guide 2mm

**Distraction Screws**

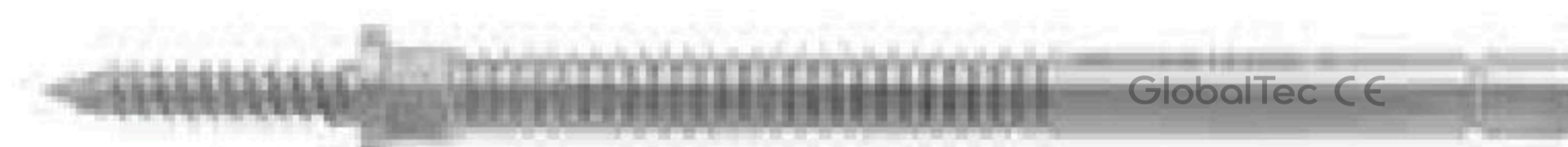
- 7cm Post Length
- Sterile Packed



	Thread length
PS GT 3002-00	12 mm
PS GT 3003-00	14 mm
PS GT 3004-00	16 mm

**SPINAL SURGERY**
**LAMINA & VERTEBRAL SPREADERS**
**Cervical Vertebral Spreader**

- 13cm/5 ¼"
- 3mm tip

PS GT 3002-00

Depth

12 mm

PS GT 3003-00

14 mm

 Depth  
95 mm\*

**Cloward Cervical Spreader**

- 17cm/6 ¾"
- Max opening 20mm

PS GT 32003-17

 Depth  
50 mm

**Cloward Lamina Spreader**

- 715cm/6"

PS GT 2004-70

 Depth  
70 mm

**SPINAL SURGERY**

**LAMINA & VERTEBRAL SPREADERS**

**Baby Inge Lamina Spreader**

- 18cm/7"

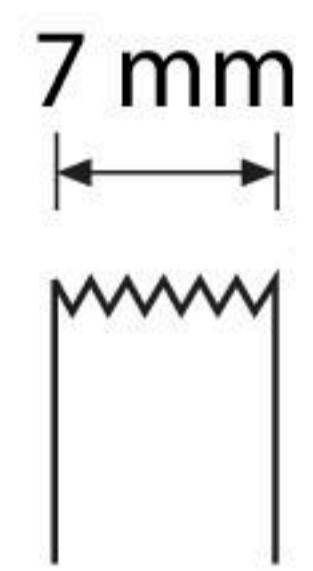

PS GT 5134-18



**Inge Lamina Spreader**

- 24cm/9 1/2", Max Opening 50mm

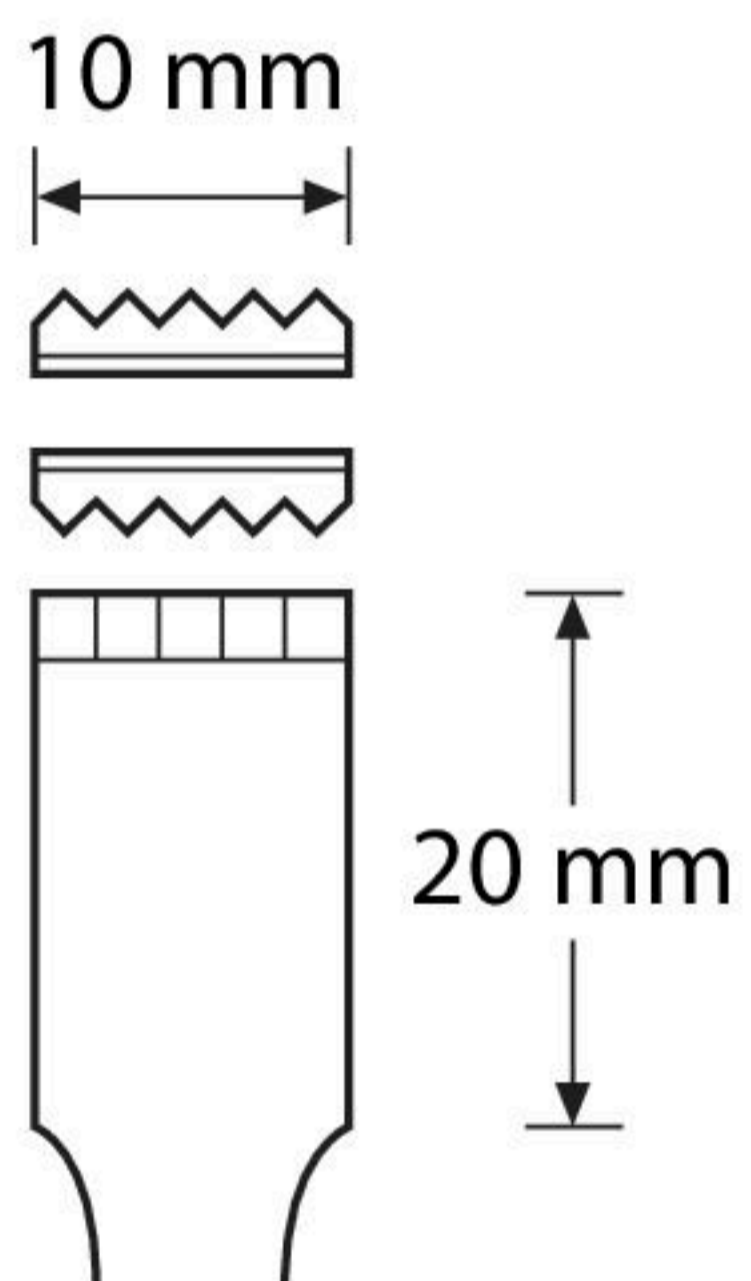

PS GT 2006-24



**Scaglietti Lamina Spreader**

- 28cm/11"
- With speed lock



PS GT 2009-28



**Long Anterior Lamina Spreader**

- 28cm/11"
- Max opening 40mm



PS GT 2008-28



SPINAL SURGERY

**HOOKS & PROBES**

Adson Dural Hook

- 19cm/7 1/2"



Sharp

SP GT 9103 -19

SP GT 9104 -19

Titanium Micro Hooks

- 19cm/7 1/2"



90° Semi-Sharp

PS GT 9103 -19

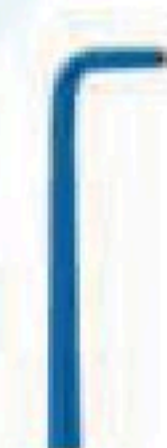

90° Blunt

MV GT 9104 -19

Crile Blunt Hook

- 20 cm/8"
- 7mm tip length



PS GT 9111- 20

Emmet Sharp Hook

- 22cm/8 3/4"
- 5mm tip length



PS GT 9106- 22

Cushing Blunt Hook

- 22cm/11"
- 4mm tip length



PS GT 9107- 28

**SPINAL SURGERY**
**HOOKS & PROBES**
**Adson Hook**

- 20cm/8"
- 5mm tip length

**Sharp**  
PS GT 9101 -19

**Blunt**  
PS GT 9104 -19

**McCulloch Probe with Ball End**

- 23.5cm/9 1/4"

**4 mm Tip**  
PS GT 5250 -13

**6 mm Tip**  
MV GT 5250 -14

**Manipulation Hook**

- 23.5cm/9 1/4"
- 4mm tip length



PS-GT 5250 -15

**Blalock Blunt Hook**

- 24cm/9 1/2"
- 5mm tip length



PS GT 9108- 24

**Caspar Exploration Probe**

- 24.5cm/9 3/4"
- Insulated shaft



PS GT 9151- 24

PS GT 9152- 24

PS GT 9153- 24

PS GT 9154- 24

**SPINAL SURGERY**

**NERVE ROOT RETRACTORS**

**Love Bayonet Nerve Root Retractor**

- 21cm/8 ¼"



PS GT 5000 -21

**Krayenbuhl Nerve Root Retractor**

- Double bayonet
- 21cm/8 ¼"



21cm/8 ¼"

PS GT 5250 -13

24cm/9 ½"

PS GT 5042 -24

**O'Connell Nerve Root Retractor**

- 21.5cm/8 ½"

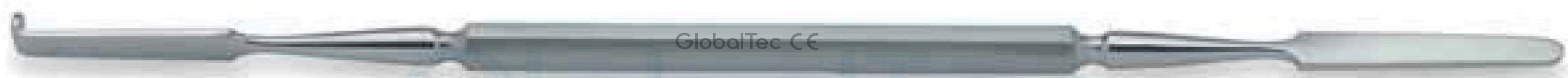

PS GT 5002 -21

**Love Nerve Root Retractor**

- 22cm/8 ¼"
- 5mm tip Width



PS GT 5010 - 22

Straight

\*illustrated

PS GT 5011-22

25° Angled

PS GT 5012 - 22

90° Angled

SPINAL SURGERY

NERVE ROOT RETRACTORS

Shepperd Suction Nerve Root Retractor

- 26cm/10 1/2"
- With suction aspiration
- Fibre optic illumination
- 4mm tip width

PS GT 5015 - 26

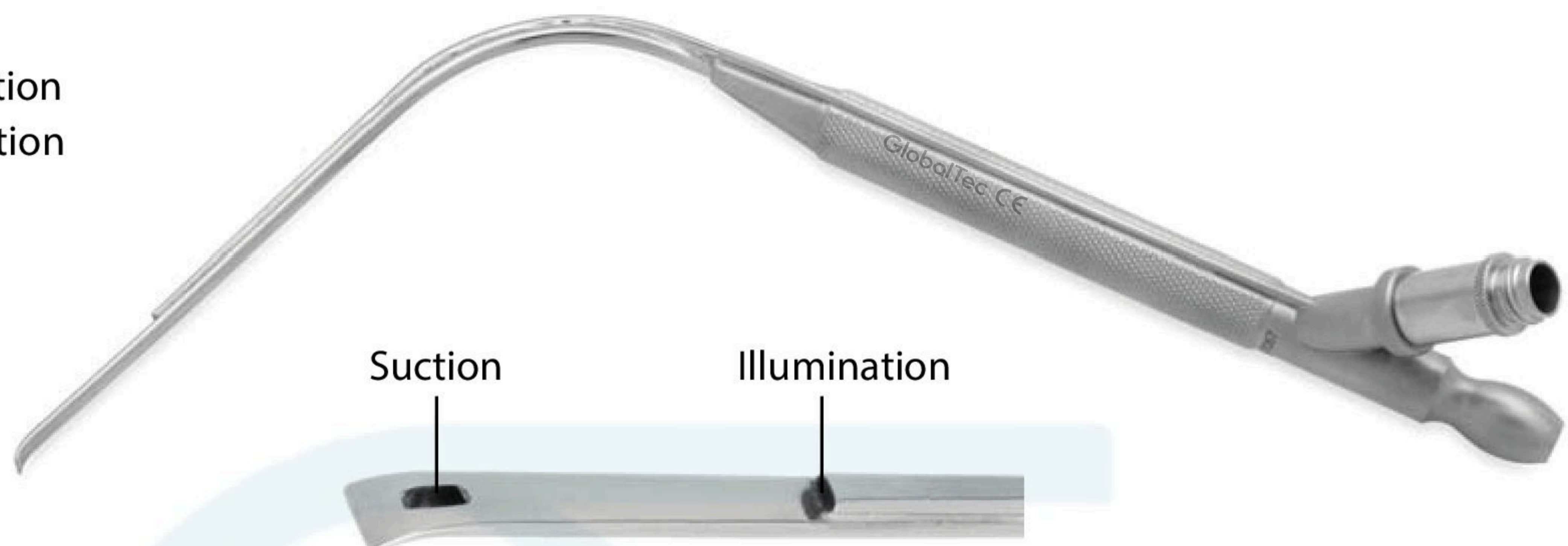

Nerve Root Retractor with suction

- 31cm/12"
- 7mm tip width

PS GT 5013 - 31



Hess Nerve Root Retractor



- 19cm/7 1/2"

	Width
PS GT 5003 -19	3 mm
PS GT 5004 -19	4 mm
PS GT 5005 -19	5 mm
PS GT 5007 -19	7 mm

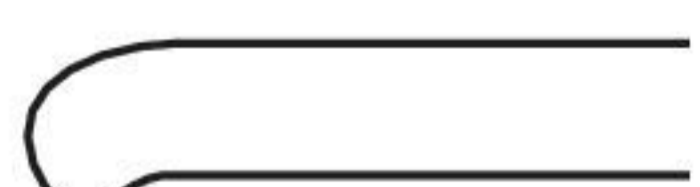
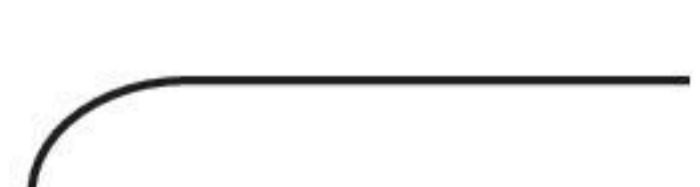

Nerve Root Retractor

19cm/7 1/2"  
With fibre optic illumination

	3 mm
	4 mm
	5 mm
	7 mm

	Width
PS GT 5033 -19	3 mm
PS GT 5055 -19	5 mm



**SPINAL SURGERY**
**HAND HELD RETRACTORS**

**Langenbeck Retractor**

- 21.5cm/8 1/2"

**Blade size**

PS GT 5050 - 22	50mm x 16mm
PS GT 5075 - 22	75mm x 25mm
PS GT 5090 - 22	90mm x 50mm

**Blade size**

PS GT 5122 - 21	22mm x 6mm
PS GT 5145 - 21	45mm x 13mm
PS GT 5165 - 21	65mm x 20mm
PS GT 5190 - 21	90mm x 20mm

**Volkman Cataspaw Retractor**

- Semi sharp teeth
- 21.5cm/8 1/2"

**Taylor Hip Retractor**

- 19cm/7 1/2"



**Depth**

PS GT 5006 - 19	70 mm
PS GT 5008 - 19	85mm
PS GT 5010 - 19	100 mm

**Bone Hook**

- 24.5cm/9 3/4"
- Sharp

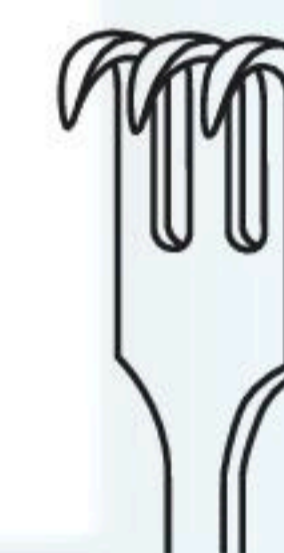
PS GT 9050 - 24

 15 x 15mm  
3 Prong

PS GT 5015 - 21

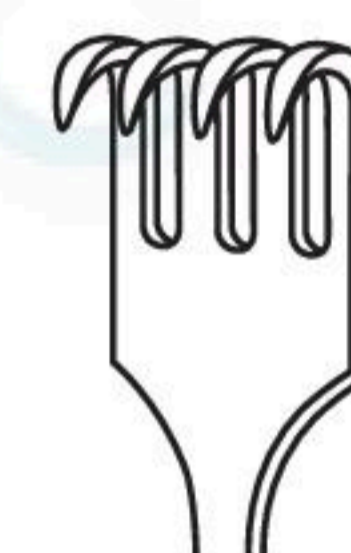
 15 x 20mm  
4 Prong

PS GT 5020 - 21

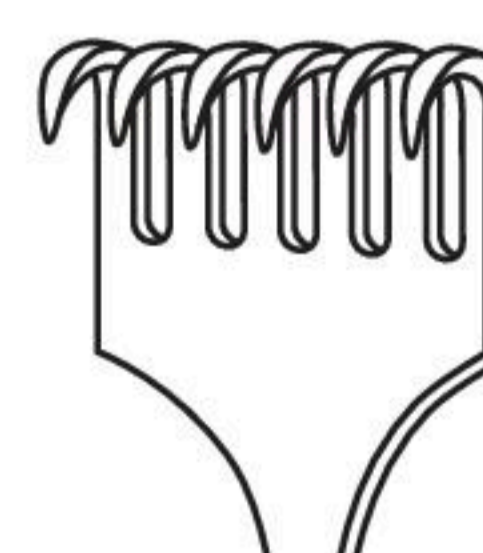
 15 x 30mm  
6 Prong

PS GT 5030 - 21

**Cloward Style Blade Retractor**

- 11cm/4 1/4"

**Width**

PS GT 5013 - 19	13 mm
PS GT 5018 - 19	18 mm
PS GT 5020 - 19	20 mm



## SPINAL SURGERY

## SELF RETAINING RETRACTORS

## Baby Weitlaner S/R Retractor

- 11.5cm/4 ½"
- 2 x 3 Blunt Prongs

PS GT 5701 -10

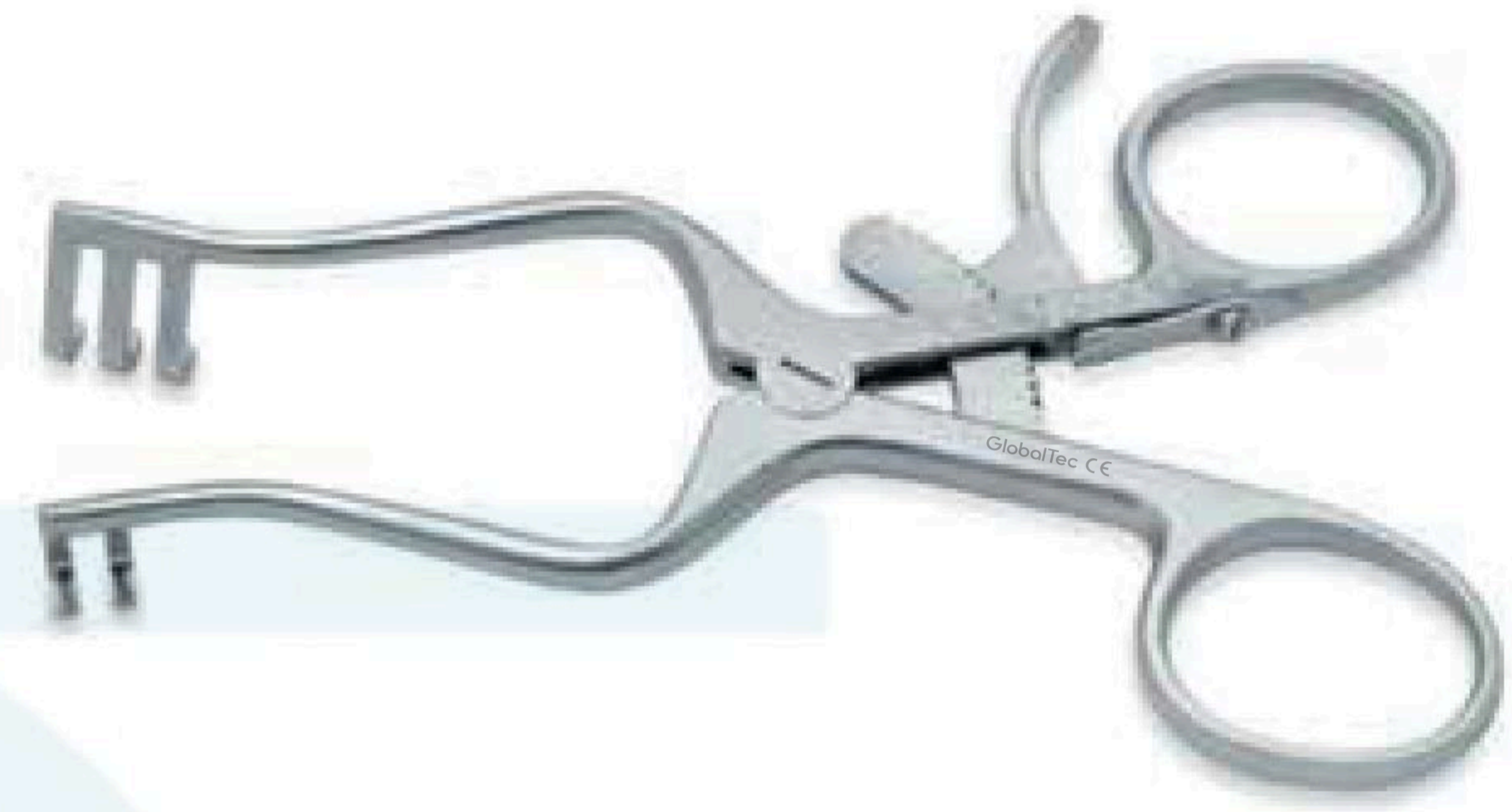

## Mollison S/R Retractor - Child

- 13cm/5 ¼"
- 2 x 2 Sharp prongs 12mm depth

PS GT 4005 -13



## Mollison S/R Retractor - Adult

- 17cm/6 ¼"
- 4 x 4 Sharp prongs 14mm depth

PS GT 4005-17



## SPINAL SURGERY

## SELF RETAINING RETRACTORS

## West's S/R Retractor

- 14cm/5 ½"
- 3 x 4 Sharp Prongs

PS GT 4003 -14



## Weitlaner S/R Retractor

- 14cm/5 ½"
- 3 x 4 Sharp Prongs

PS GT 4002 -14

## Travers S/R Retractor

- 20cm/8"
- 4 x 5 Blunt Prongs

PS GT 4004 -20



## Norfolk and Norwich S/R Retractor

- 20cm/8"
- 4 x 5 Blunt Prongs

PS GT 4000 - 20



**SPINAL SURGERY**
**SELF RETAINING RETRACTORS**
**Cones Self Retaining Retractor**

- 3 x 4 Prongs
- Jointed Arms

PSGT4003 -14

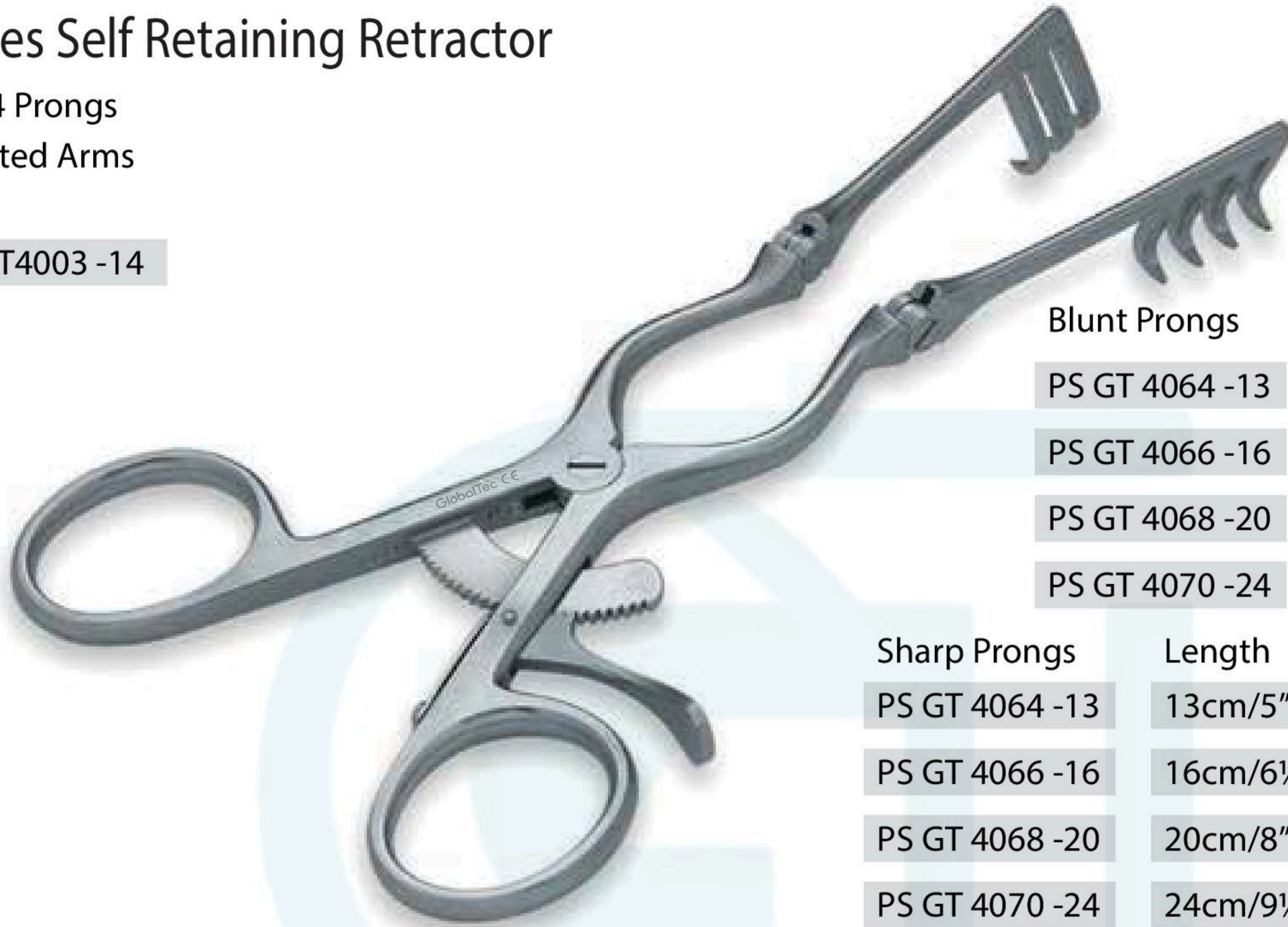
**Blunt Prongs      Length**

PSGT 4064 -13      13cm/5"

PSGT 4066 -16      16cm/6½"

PSGT 4068 -20      20cm/8"

PSGT 4070 -24      24cm/9½"

**Sharp Prongs      Length**

PSGT 4064 -13      13cm/5"

PSGT 4066 -16      16cm/6½"

PSGT 4068 -20      20cm/8"

PSGT 4070 -24      24cm/9½"

**Beckman - Adson Retractor**

- 31cm/12"
- 4 x 5 Blunt Prongs
- Jointed Arms

PSGT 4001- 32      32mm Deep blades



SPINAL SURGERY

SELF RETAINING RETRACTORS

Gelpi Laminectomy Retractor

- Sharp Prongs
- Jointed Arms

		Prong depth
• 18.5cm/7 ¼"	PS GT 4030-16	30 mm
• 19.5cm/7 ¾"	PS GT 4050-16	50 mm
• 20cm/8"	PS GT 4070-16	70 mm



Hardman Retractor

- 20cm/8"

	Prong depth
PS GT 4050 - 20	50mm equal prongs
PS GT 4500 - 20	long prong - Left*
PS GT 4300 - 20	long prong - Right

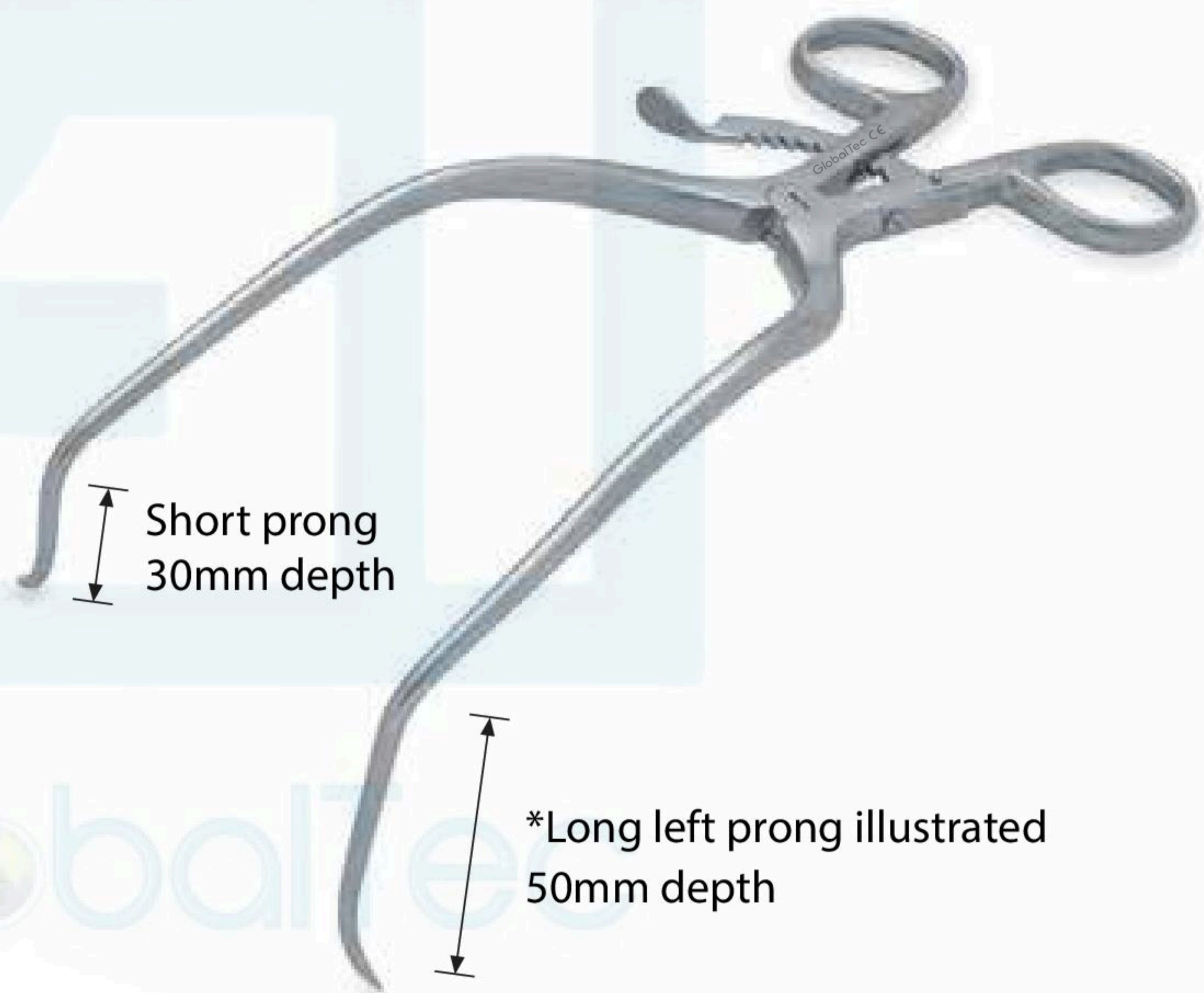

Meyerding Hemi Laminectomy Retractor

- 18cm/7"

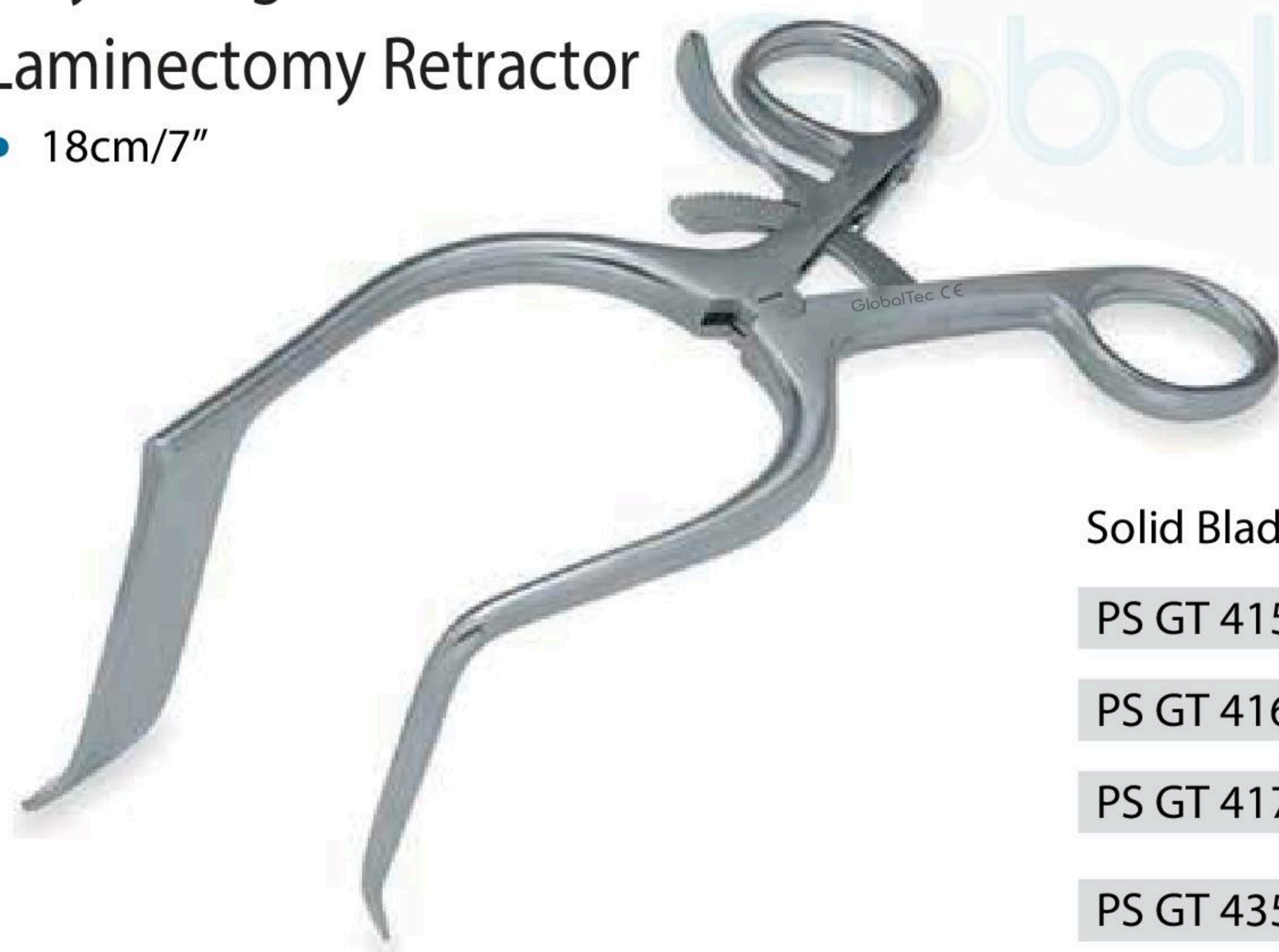

Solid Blade Left	Blade Size	Solid Blade Right	
PS GT 4150 - 18	50 x 10mm	SP GT 4250 - 18	Narrow Blade
PS GT 4160 - 18	60 x 10mm	SP GT 4260 - 18	
PS GT 4170 - 18	70 x 10mm	SP GT 4270 - 18	
PS GT 4350 - 18	50 x 10mm	SP GT 4250 - 18	Wide Blade
PS GT 4360 - 18	60 x 10mm	SP GT 4260 - 18	
PS GT 4370 - 18	70 x 10mm	SP GT 4270 - 18	

**SPINAL SURGERY**
**SELF RETAINING RETRACTORS**
**Long Gelpi Orthopaedic Retractor**

- 30cm/11¾"
- Sharp Prongs

	Depth Prongs
PS GT 7245 -10	70 mm
PS GT 7245 -12	100 mm

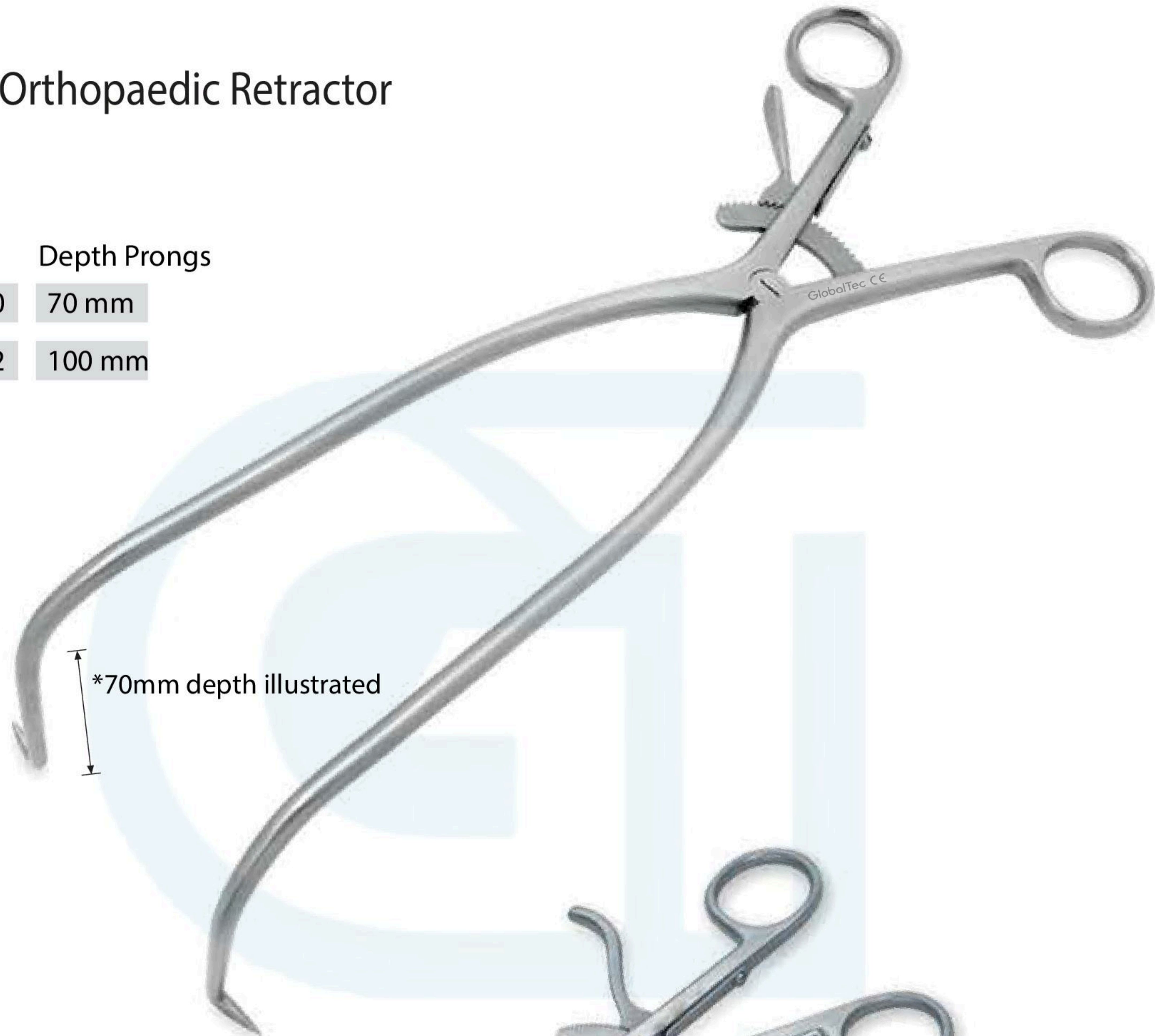
**Viper Scoliosis Retractor**

- 30cm/11¾"
- Sharp Prongs

	Depth Prongs
PS GT7248 - 38	40 mm
PS GT 7248 - 40	70 mm
PS GT 7248 - 50	100 mm

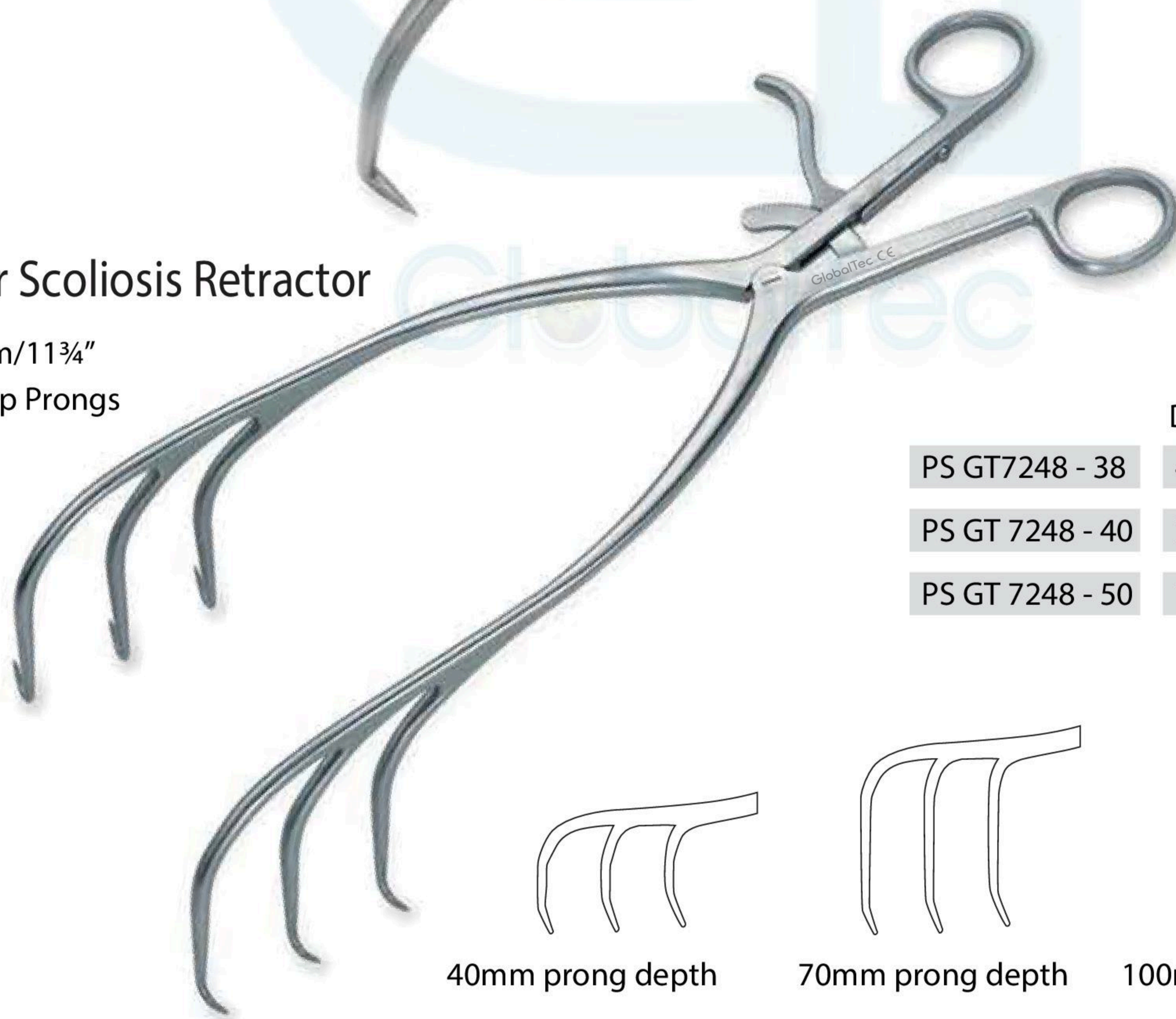

40mm prong depth

70mm prong depth

100mm prong depth

# SPINAL SURGERY

## MICRO DISCECTOMY RETRACTOR



- This Specialist Retractor allows the Consultant the optimal exposure to the Disc with the minimum incision.
- The Design of the Retractor allows unhindered access around the wound with the jointed arms folding along the patients Back.

- The Black finish eliminates distracting reflections under the Microscope during Surgery.
- The wide selection of Blades available allows the Surgeon full flexibility in approaches to the Disc.

### Basic Micro-Discectomy Retractor Set

PS GT5200 - 00

Complete set consisting of:

Qty	Order Code	Description
1 each	PS GT 5202 - 00	Retractor Frame
4 pairs	PS GT 5204 - 40	Wide Muscle Blades Sizes 4cm to 7cm depth
4 pairs	PS GT 5206 - 40	Narrow Muscle Blades Sizes 4cm to 7cm depth
4 each	PS GT 5208 - 40	Hook Blades Sizes 3cm to 6cm depth
4 each	PS GT 5210 - 40	Toothed Blades Sizes 3cm to 6cm depth
1 each	PS GT 5200 - 10	Instrument Container

### Extended Micro-Discectomy Retractor Set

PS GT 5200 - 01

Complete set consisting of:

Qty	Order Code	Description
1 each	PS GT 5202 - 00	Retractor Frame
4 pairs	PS GT 5204 - 40	Wide Muscle Blades Sizes 4cm to 7cm depth
4 pairs	PS GT 5206 - 40	Narrow Muscle Blades Sizes 4cm to 7cm depth
4 each	PS GT 5208 - 40	Hook Blades Sizes 3cm to 6cm depth
4 each	PS GT 5210 - 40	Toothed Blades Sizes 3cm to 6cm depth
1 each	PS GT5200 - 10	Instrument Container

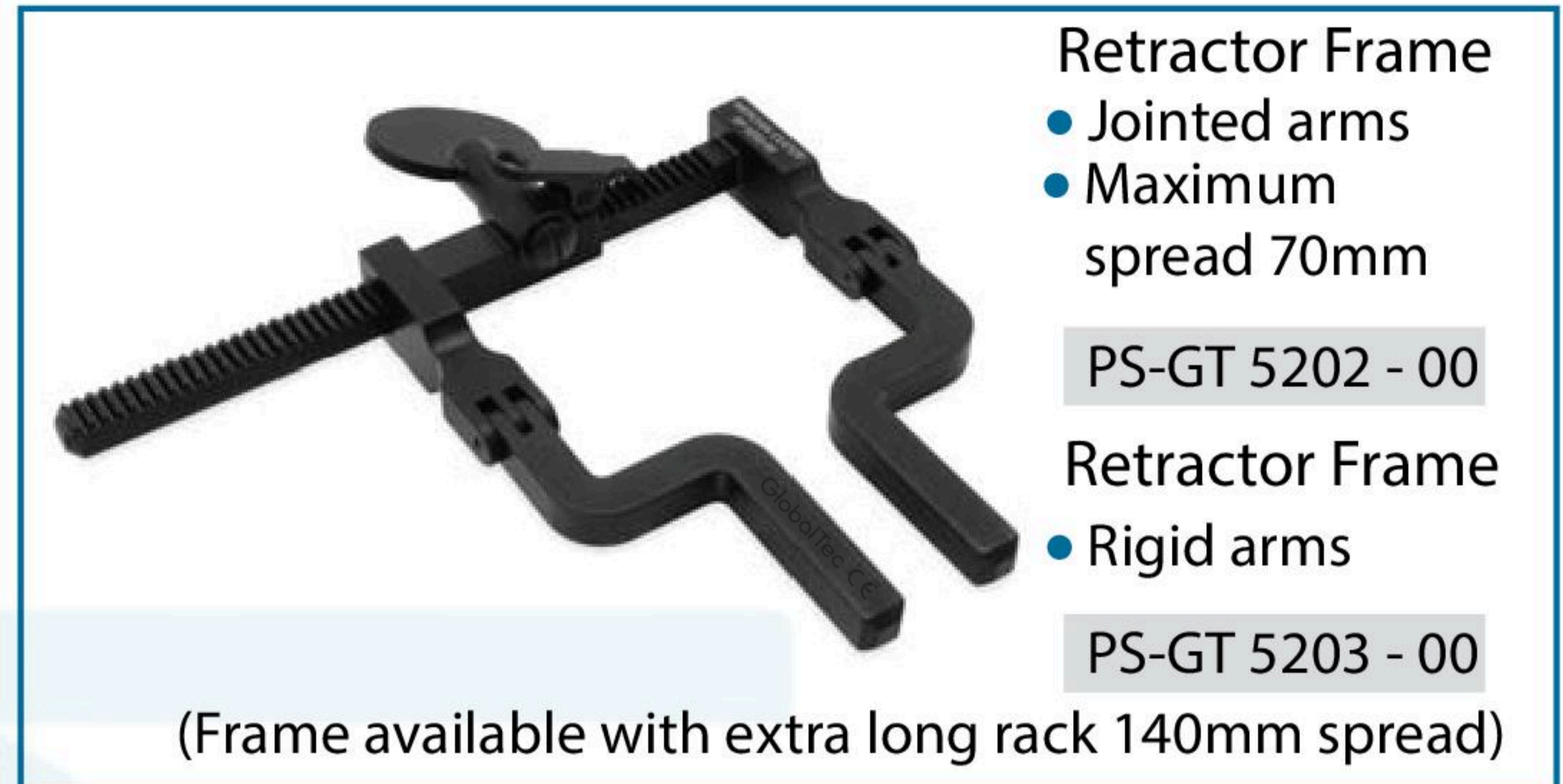
**SPINAL SURGERY**
**MICRO DISCECTOMY RETRACTOR**

Hook Blades

PS GT 5208 - 02	2 cm depth
PS GT 5208 - 03	3 cm depth
PS GT 5208 - 04	4 cm depth
PS GT 5208 - 05	5 cm depth
PS GT 5208 - 06	6 cm depth
PS GT 5208 - 07	7 cm depth
PS GT 5208 - 08	8 cm depth
PS GT 5208 - 09	9 cm depth
PS GT 5208 - 10	10 cm depth

Extra Deep



Wide Muscle Blades - Teeth

Extra Deep

27mm width	
PS GT 5204 - 03	3 cm depth
PS GT 5204 - 04	4 cm depth
PS GT 5204 - 05	5 cm depth
PS GT 5204 - 06	6 cm depth
PS GT 5204 - 08	7 cm depth
PS GT 5204 - 03	8 cm depth
PS GT 5204 - 09	9 cm depth
PS GT 5204 - 10	10 cm depth
PS GT 5204 - 12	11 cm depth



Narrow Muscle Blades - Teeth

Extra Deep

20mm width	
PS GT 5206 - 03	3 cm depth
PS GT 5206 - 04	4 cm depth
PS GT 5206 - 05	5 cm depth
PS GT 5206 - 06	6 cm depth
PS GT 5206 - 08	7 cm depth
PS GT 5206 - 03	8 cm depth
PS GT 5206 - 09	9 cm depth
PS GT 5206 - 10	10 cm depth
PS GT 2506 - 12	11 cm depth



Toothed Blades

PS GT 5210 - 03	3 cm depth
PS GT 5210 - 04	4 cm depth
PS GT 5210 - 05	5 cm depth
PS GT 5210 - 06	6 cm depth
PS GT 5210 - 08	7 cm depth
PS GT 5210 - 03	8 cm depth
PS GT 5210 - 09	9 cm depth
PS GT 5210 - 10	10 cm depth
PS GT 5210 - 12	11 cm depth

Extra Deep



Thin Muscle Blades - 2 Teeth

17 mm width	
PS GT 5207 - 03	3 cm depth
PS GT 5207 - 04	4 cm depth
PS GT 5207 - 05	5 cm depth
PS GT 5207 - 06	6 cm depth
PS GT 5207 - 07	7 cm depth
PS GT 5207 - 08	8 cm depth

# SPINAL SURGERY

## MICRO DISCECTOMY INSTRUMENT SET

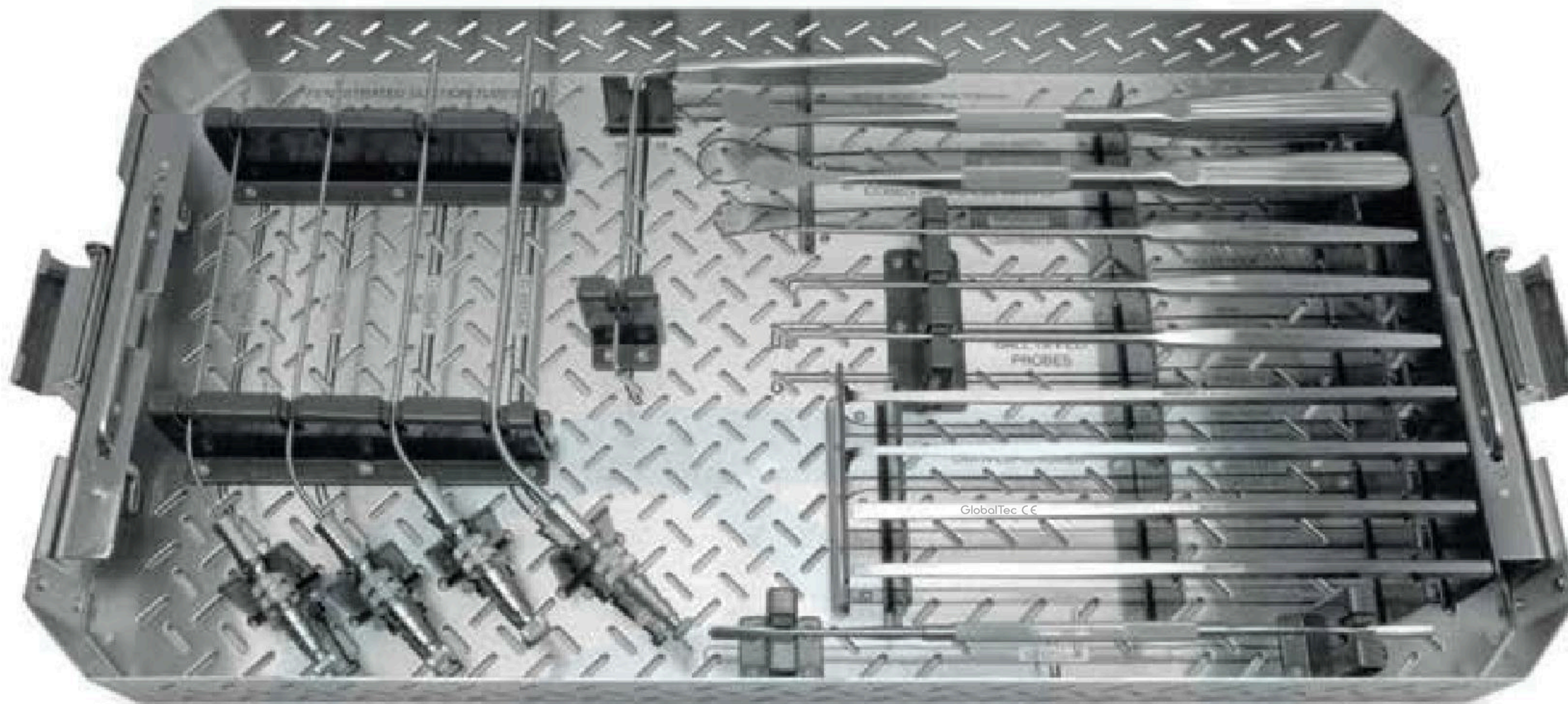

### McCulloch Style Instrument Set with Container

Complete set consisting of:

PS GT 5200 - 05

Qty	Order Code	Description
1	PS GT 5250 - 15	McCulloch Spinal Hook, 4mm tip - 23cm/9" length
1	PS GT 5250 - 13	McCulloch Spinal Probe, 4mm tip - 23cm/9" length
1	PS GT 5250 - 14	McCulloch Spinal Probe, 6mm tip - 23cm/9" length
1	PS GT 5250 - 07	Cobbs Spinal Elevator, 12mm width - 26cm/10 1/4" length
1	PS GT 5250 - 08	Cobbs Spinal Elevator, 19mm width - 26cm/10 1/4" length
1	PS GT 5250 - 03	Spinal Osteotome, 4mm width - 22cm/8 1/2" length
1	PS GT 5250 - 04	Spinal Osteotome, 6mm width - 22cm/8 1/2" length
1	PS GT 5250 - 05	'Hockey Stick' Chisel, 5mm width - 22cm/8 1/2" length, curved right
1	PS GT 5250 - 06	'Hockey Stick' Chisel, 5mm width - 22cm/8 1/2" length, curved left
1	PS GT 5250 - 01	Elevator Double Ended, 24cm/9 3/4" length
1	PS GT 5250 - 01	McCulloch Suction Tube, Fenestrated tip, 23cm/9" length, 6FG, 2.0mm Ø
1	PS GT 5250 - 10	McCulloch Suction Tube, Fenestrated tip, 23cm/9" length, 7FG, 2.3mm Ø
1	PS GT 5250 - 11	McCulloch Suction Tube, Fenestrated tip, 23cm/9" length, 9FG, 3.0mm Ø
1	PS GT 5250 - 12	McCulloch Suction Tube, Fenestrated tip, 23cm/9" length, 12FG, 4.0mm Ø
1	PS GT 5250 - 02	McCulloch Nerve Root Retractor, 90 angled, 6mm tip, 12.5cm/5" working length

### McCulloch Style Spinal Hook/Probe

- 23cm/9" length

Hook  
Tip 4mm

PS GT 5250 - 15



Probe Ball  
Tip 4mm

PS GT 5250 - 13



Probe Ball  
Tip 6mm

PS GT 5250 - 14



**SPINAL SURGERY**
**MICRO DISCECTOMY SET**
**Cobbs Spinal Elevator**

- 26cm/10 ¼" length

	Width
PS GT 250 - 07	12 mm
PS GT 250 - 07	12 mm

**Cobbs Spinal Elevator**

- 26cm/10 ¼" length

	Width
PS GT 250 - 07	12 mm
PS GT 250 - 07	12 mm

**Cobbs Spinal Elevator**

- 26cm/10 ¼" length

	Width
PS GT 250 - 07	12 mm
PS GT 250 - 07	12 mm

**Cobbs Spinal Elevator**

- 26cm/10 ¼" length

	Width
PS GT 250 - 07	12 mm
PS GT 250 - 07	12 mm

**Cobbs Spinal Elevator**

- 26cm/10 ¼" length

	Width	Width
PS GT5250 - 09	6FG	2.0mm Ø
PS GT5250 - 10	7FG	2.3mm Ø
PS GT 5250 - 11	9FG	3.0mm Ø
PS GT 5250 - 12	12FG	4.0mm Ø

**McCulloch Nerve Root Retractor**

- 90 Angled
- 6mm tip
- 12.5cm/5" working length

PS GT 5250 - 02
-----------------

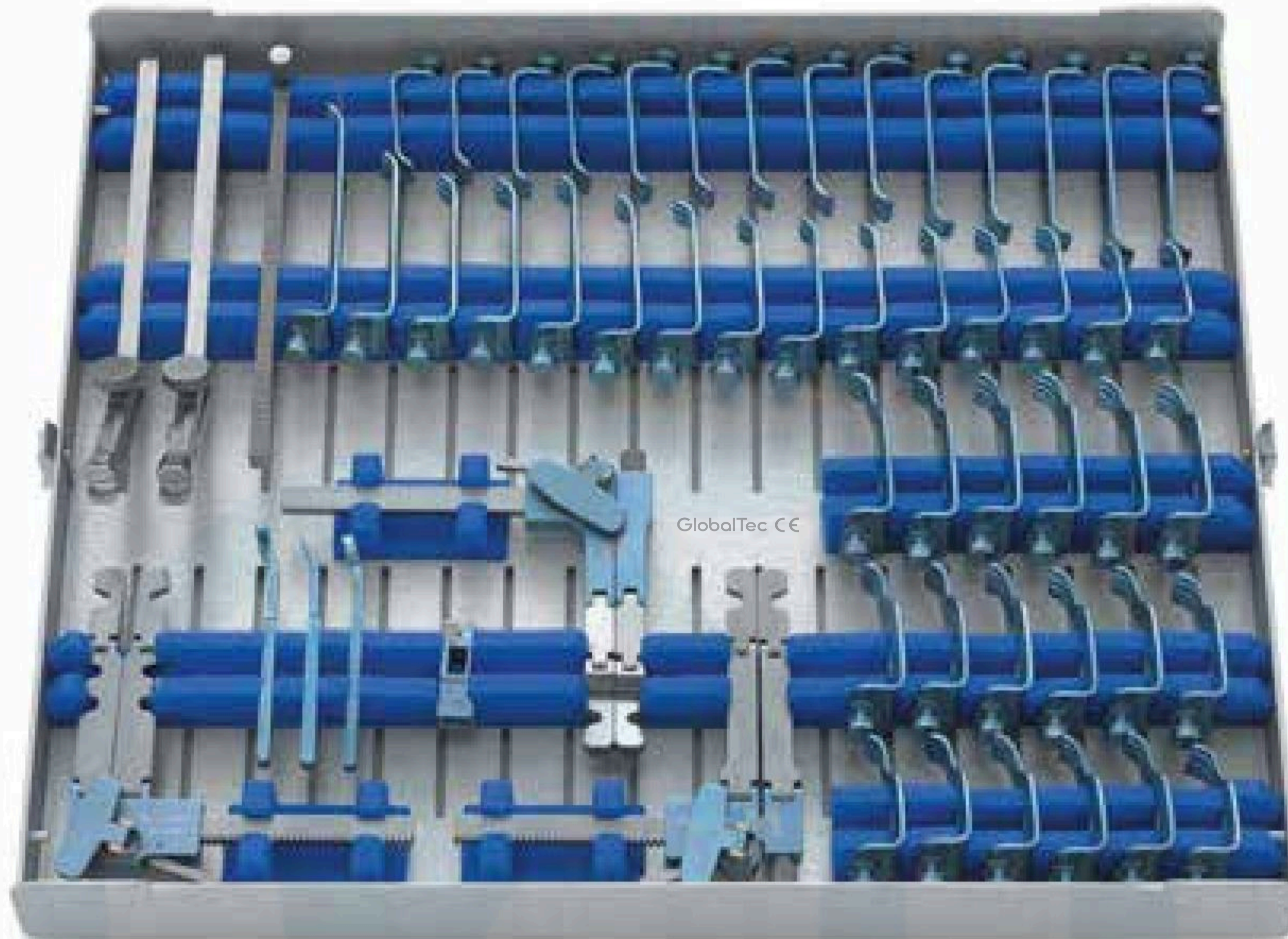

**SPINAL SURGERY**
**'BLACK BELT' ADVANCED CERVICAL RETRACTOR SET**

\*Titanium Blade Set  
Illustrated

An advanced Cervical retractor system suitable for both Anterior and Posterior Cervical Surgery but with attachments for Micro Discectomy Surgery.

**Basic 'Black Belt' Cervical Retractor System**

Complete set consisting of: **GT 7320 - 00**

Qty	Order Code	Description
1	GT 7320 -10	Retractor Frame RIGHT
1	GT 7320 -20	Retractor Frame LEFT
1	GT 7320 -30	Retractor Frame OFFSET
2	GT 7320 -40	Blade Insertion Clamps
14	GT 7322 - 34/70	Pronged Blades 34mm - 70mm
14	GT 324 - 34/70	Blunt Blades 34mm - 70mm
12	GT 7326 - 40/55	Two Level Pronged Blades 40mm - 55mm
6	GT7328- 40/55	Two Level Blunt Blades 40mm - 55mm
1	GT 7320 - 50	Container

**Extended 'Black Belt' Cervical Retractor System**

Consisting of: **GT 5200 - 05**

Standard 'Black Belt' Retractor with the addition of Micro Discectomy Attachments as detailed on page 56

**Coloured Titanium 'Black Belt' Cervical Retractor System**

Complete set consisting of: **GT 7320 - 00M**

Qty	Order Code	Description
1	GT 7320 -10M	Retractor Frame RIGHT
1	GT 7320 -20M	Retractor Frame LEFT
1	GT 7320 -30M	Retractor Frame OFFSET
2	GT 7320 -40M	Blade Insertion Clamps
14	GT 7322 - 34/7M	Pronged Blades 34mm - 70mm
14	GT 324 - 34/70M	Blunt Blades 34mm - 70mm
12	GT 7326 - 40/55 M	Two Level Pronged Blades 40mm - 55mm
6	GT 7328- 40/M55M	Two Level Blunt Blades 40mm - 55mm
1	GT 7320 - 50M	Container

**Coloured Titanium Extended 'Black Belt' Cervical Retractor System**

Consisting of: **GT 7320 - 05M**

Standard 'Black Belt' Retractor with the addition of Micro Discectomy Attachments as detailed on page 56

## SPINAL SURGERY

### 'BLACK BELT' ADVANCED CERVICAL RETRACTOR SET

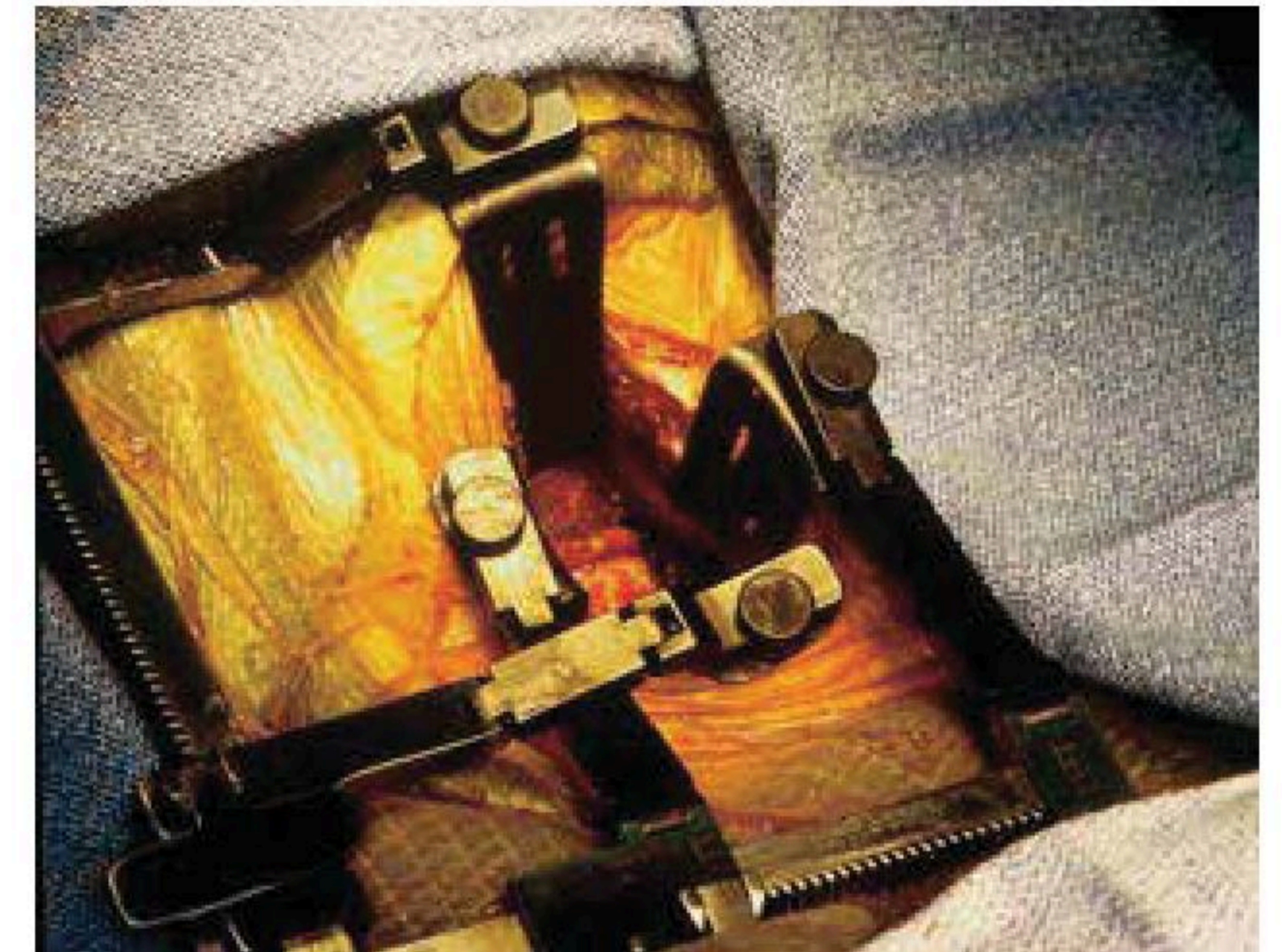

- Full jointed retractor arms
- Black non-glare finish
- Wide blade range
- Suitable for single or multi level retraction

#### Blades

- The blade shape is designed to resist climbing out of the surgical site
- The wider two level blades have an extra bend near the tip which follows the contour of the vertebrae or visualising



27mm wide two level Pronged blade    27mm wide two level blade    22mm wide Pronged blade    22mm wide Blunt blade    17mm wide optional narrow Cervical blades 40mm to 60mm depth

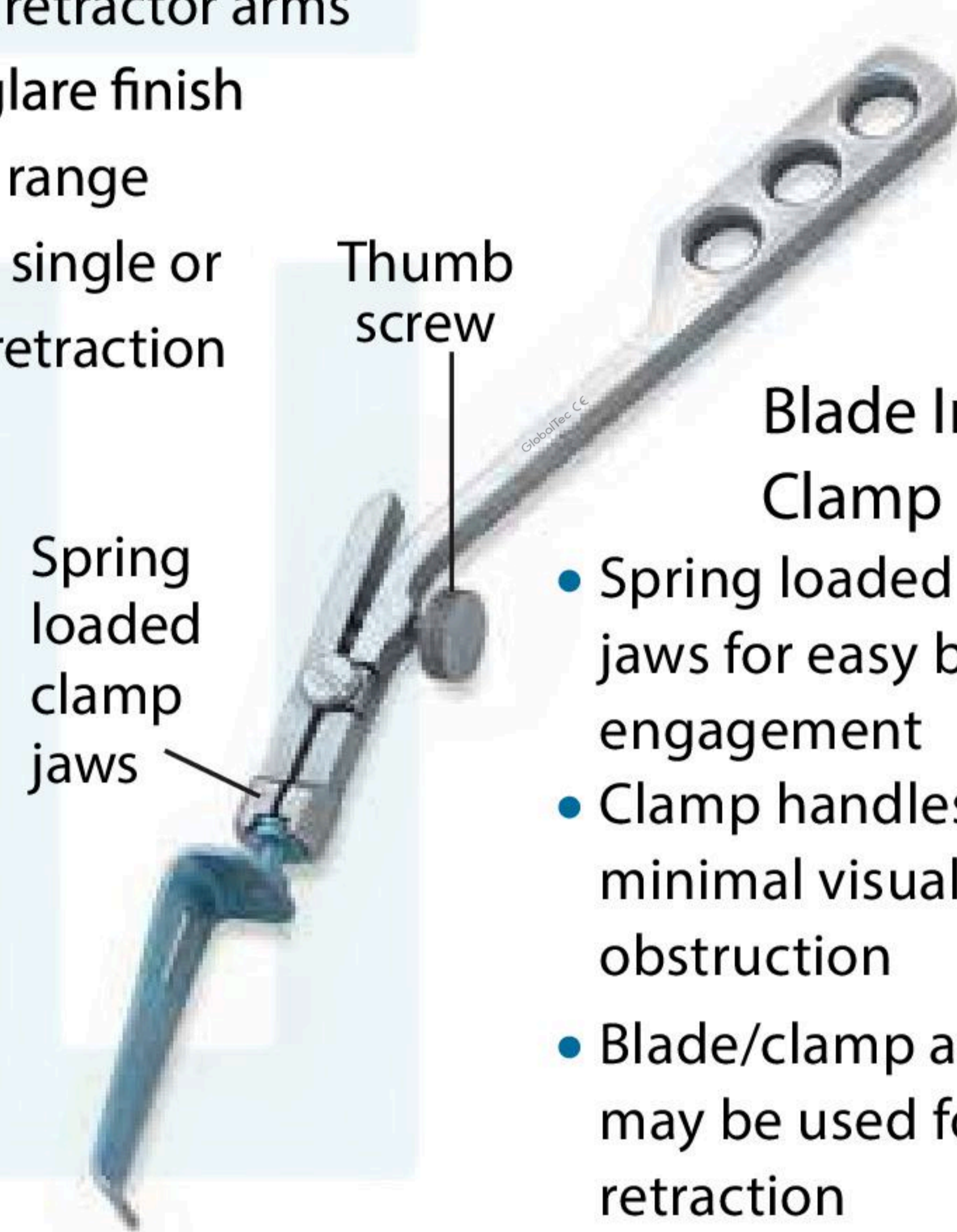

#### Blade Inserter Clamp

- Spring loaded clamping jaws for easy blade engagement
- Clamp handles create minimal visual obstruction
- Blade/clamp assembly may be used for hand retraction
- Clamps are quickly/easily removed after retractor arms have securely engaged the blades

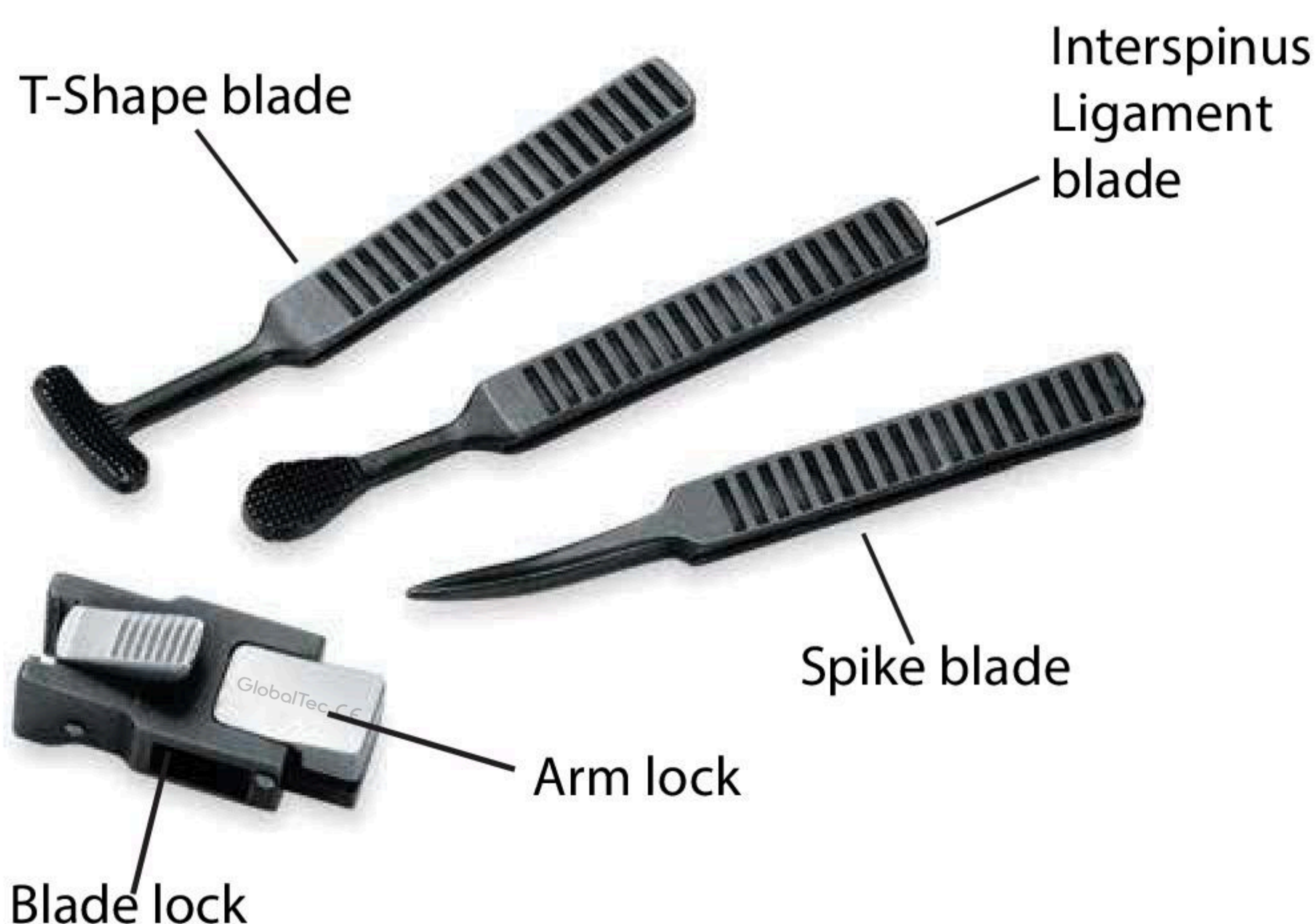

#### Lumbar Micro Discectomy Attachments

With this set the standard Cervical Retractor becomes a Lumbar Microdiscectomy Retractor unit.

GT 7321 - 00

Complete set consisting of:

Qty	Order Code	Description
1	GT 7321 - 10	Micro Disc attachment
1	GT 7321 - 20	Spike Blade
1	GT 7321 - 30	T-Shape Blade
1	GT 7321 - 40	Inner Spine Ligament Blade
1	GT 7321- 85	Pronged Blade 85mm depth

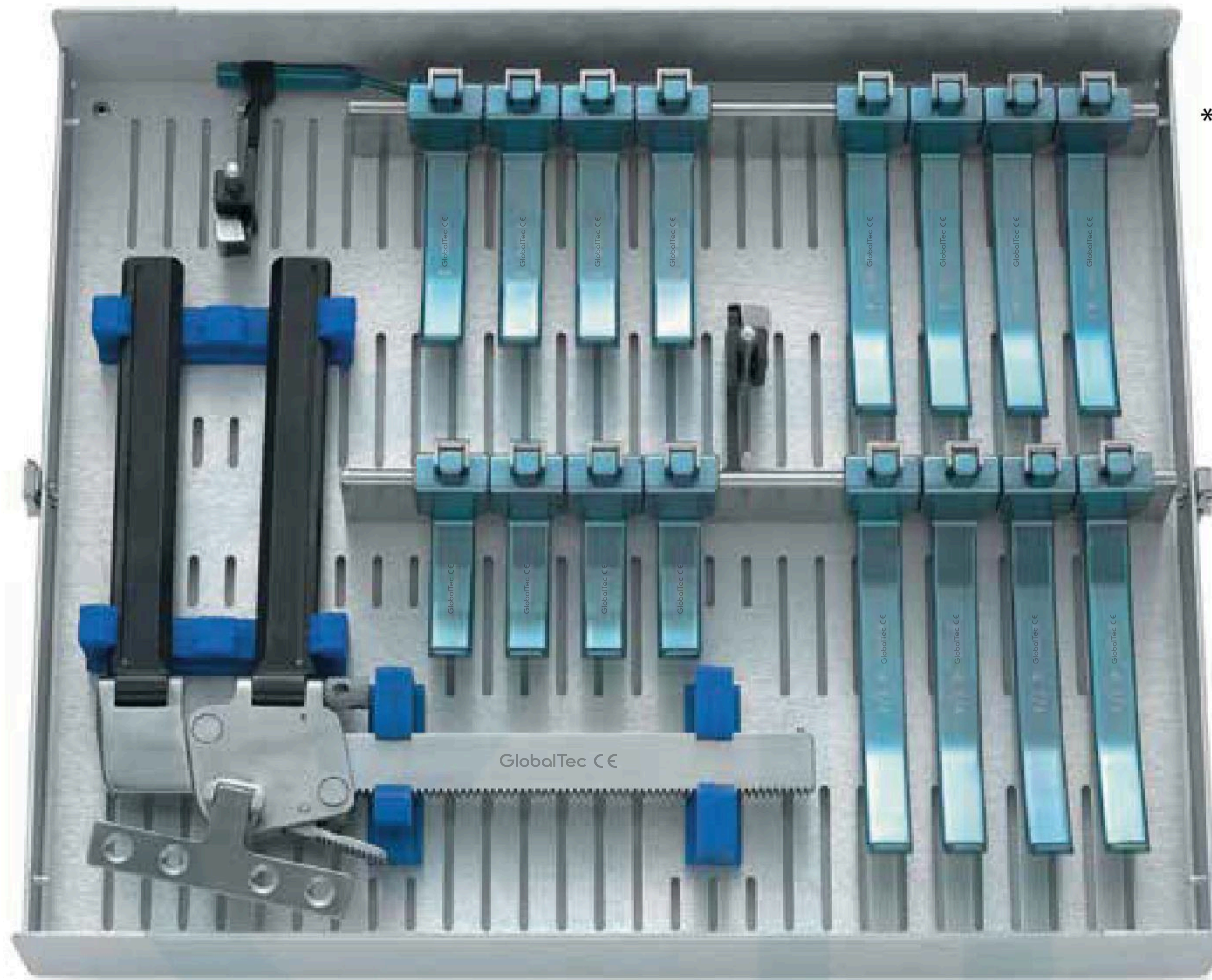
**SPINAL SURGERY**
**SUPER-SLIDE II LAMINECTOMY RETRACTOR SET**

\* Titanium Blade Set Illustrated

A powerful retractor with a selection of blade depths which can be positioned anywhere along the retractor arms. Allows excellent exposure of the spine in Pedicle Screw and Laminectomy procedures.

**Super-Slide Retractor Basic Set**

Complete set consisting of: **GT 7329 - 00**

Qty	Order Code	Description
1	GT 7329 - 10	Retractor Frame
4	GT 7329 - 20	Small blades 2" deep
4	GT 7329 - 30	Medium blades 3" deep
4	GT 7329 - 40	Large blades 4" deep
1	GT 7329 - 50	Instrument container

**Super-Slide Retractor Extended Set**

**GT 7329 - 00** Includes components of basic set plus:

Qty	Order Code	Description
4	GT 7329 - 47	Supplementary blades 4 3/4" deep
2	GT 7329 - 60	Unilateral blade heads
2	GT 7329 - 62	Unilateral T-blades

**Titanium Super-Slide Retractor Basic Set**

Complete set consisting of: **GT 7329 - 06**

Qty	Order Code	Description
1	GT 7329 - 10	Retractor Frame
4	GT 7329 - 82	Small Titanium blades 2" deep
4	GT 7329 - 84	Medium Titanium blades 3" deep
4	GT 7329 - 86	Large Titanium blades 4" deep
1	GT 7329 - 90	Instrument container

**Titanium Super-Slide Retractor Extended Set**

**GT 7329 - 09** Includes components of Titanium basic set plus:

Qty	Order Code	Description
4	GT 7329 - 47	Supplementary Titanium blades 4 3/4" deep
2	GT 7329 - 60	Unilateral blade heads
2	GT 7329 - 62	Unilateral Titanium T-blades

## SPINAL SURGERY

### SUPER-SLIDE II LAMINECTOMY RETRACTOR SET

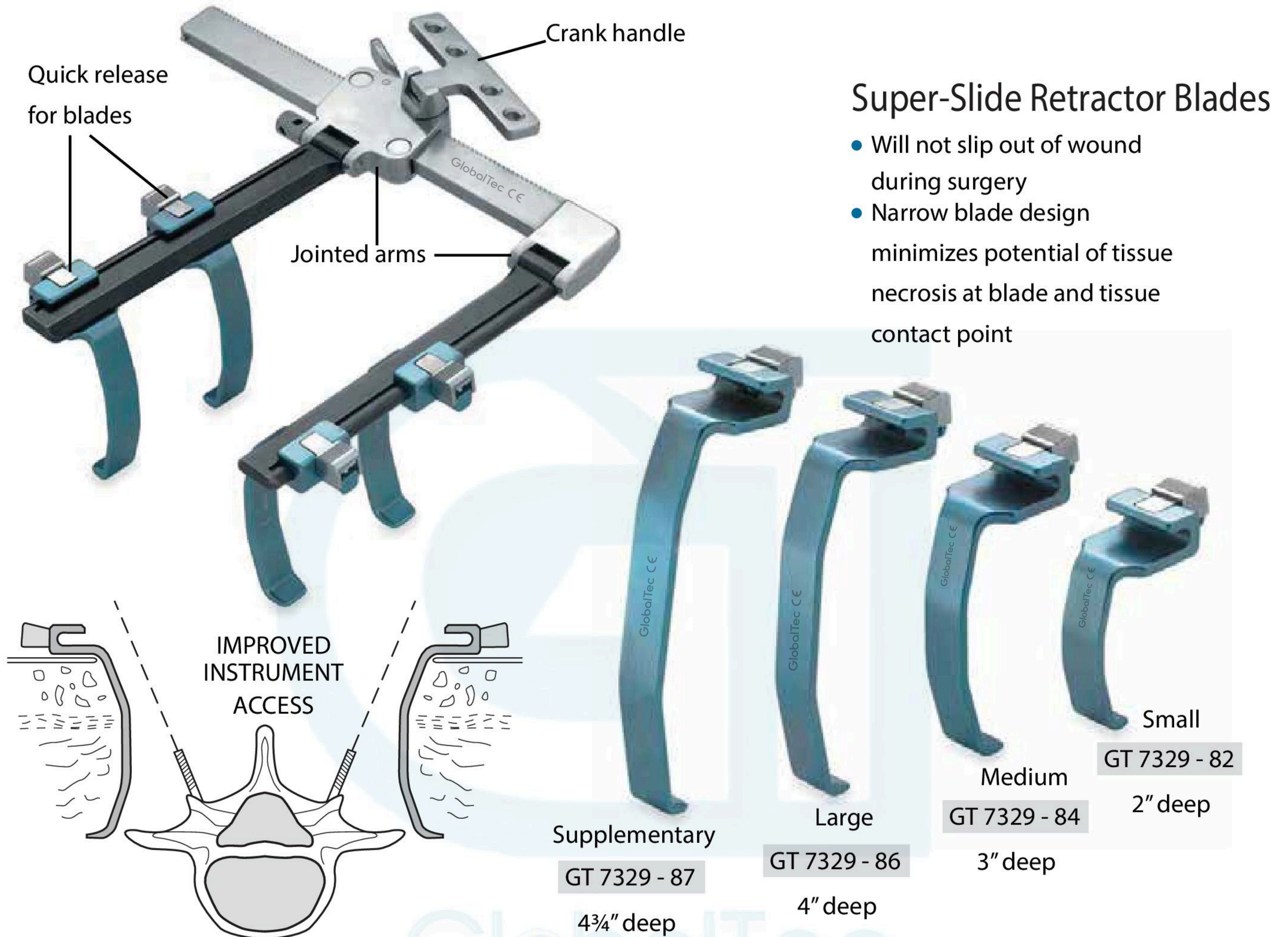

#### Unilateral Blade Attachment

- Blades lock into any chosen position along the retractor arms and may be changed at any time during surgery
- Arm locks allow the surgeon the choice of either attaching to the retractor arms then placing the unit into the wound or placing the blades into the wound then engaging the frame arms
- To obtain a unilateral exposure, use the unilateral blade attachments contained in the extended set. The T-Blade is designed to attain a firm purchase on the Spinous process
- The T-Blade can be adjusted to the correct depth with the blade lock



**SPINAL SURGERY**
**CASPAR MICRO LUMBAR DISCECTOMY RETRACTOR**

**Caspar Micro Discectomy Retractor**

- This Retractor Set allows a micro surgery approach to Lumbar Disc
- Specula have a black surface finish to prevent glare
- Fenestrated blades on the specula reduce the risk of movement during surgery

**Complete Set**
**PS GT 5100- 00**

Consisting of:

Lateral Blades	Depth	Specula	Depth
PS GT 5101- 40	40mm	PS GT 5100- 40	40mm
PS GT 5101- 45	40mm	PS GT 5100- 45	45mm
PS GT 5101- 50	40mm	PS GT 5100- 50	50mm
PS GT 5101- 55	40mm	PS GT 5100- 55	55mm
PS GT 5101- 60	40mm	PS GT 5100- 60	60mm
PS GT 5101- 65	40mm	PS GT 5100- 65	65mm
PS GT 5101- 70	40mm	PS GT 5100- 70	70mm

**PS GT 5102- 00 Counter Retractor Frame**
**PS GT 5103- 00 Blade Ejector Forceps**

**SPINAL SURGERY**

**CASPAR MICRO LUMBAR DISCECTOMY RETRACTOR**

Lateral Blades



Blade Ejector Forceps

5103- 00



Specula Range



Caspar Micro Discectomy Retractor Frame

PS GT 5102- 00

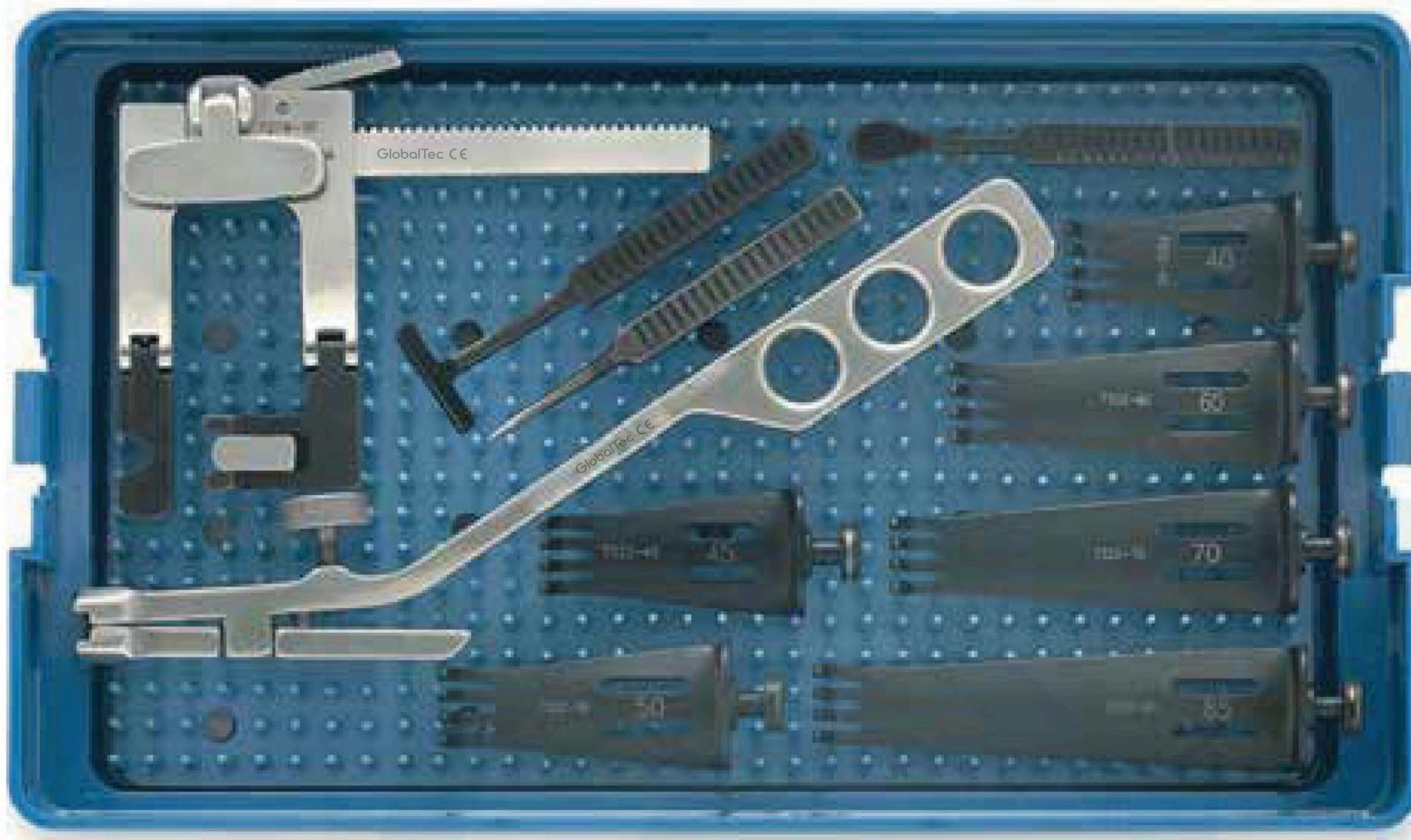

**SPINAL SURGERY**
**BLACK BELT MICRO DISCECTOMY RETRACTOR SET**

**Black Belt Micro Discectomy Retractor Set**

A specialist retractor for Lumbar Micro Discectomy Surgery featuring:

- Jointed retractor arms
- Adjustable blade depth
- Range of pronged blades
- Powerful ratchet action with quick release mechanism

GT 7276 - 00 Complete set

Complete set consisting of:

Qty	Order Code	Description
1	GT 7276 -10	Retractor Frame
1	GT 7276 -15	Blade Inserting Clamp
1	GT 7276 -20	Spike Blade
1	GT 7276 -30	T-Shape Blade
1	GT 7276 -35	Inner Spine - Ligament Blade
1	GT 7276 -40	Pronged Blade 40mm
1	GT 7276 -45	Pronged Blade 45mm
1	GT 7276 -50	Pronged Blade 50mm
1	GT 7276 -60	Pronged Blade 60mm
1	GT 7276 -70	Pronged Blade 70mm
1	GT 7276 -85	Pronged Blade 85mm
1	GT 7276 -90	Sterilising Container



**SPINAL SURGERY**
**BAYONET MICRO INSTRUMENTS FOR DURAL REPAIRS**
**Yasargil Bayonet Micro Needle Holder**

- Flat Handled
- Delicate 1mm Jaws



With Lock	Straight	Curved	Without Lock	Straight	Curved
23cm/9"	MV GT 1012 - 23	MV GT1013 - 23	23cm/9"	MV GT1112 - 23	MV GT1112 - 23

**Bayonet Micro Needle Holder**

- Round Bodied
- Delicate 1mm Jaws



With Lock	Straight	Curved	Without Lock	Straight	Curved
21cm/8 ¼"	MV GT1010 - 21	MV GT1011 - 21	21cm/8 ¼"	MV GT1010 - 21	MV GT1011 - 21
23cm/9"	MV GT1010 - 23	MV GT1011 - 21	23cm/9"	MV GT1010 - 23	MV GT1011 - 21

**Yasargil Bayonet Micro Forceps**

- Flat Handled
- Blunt 1mm Tips

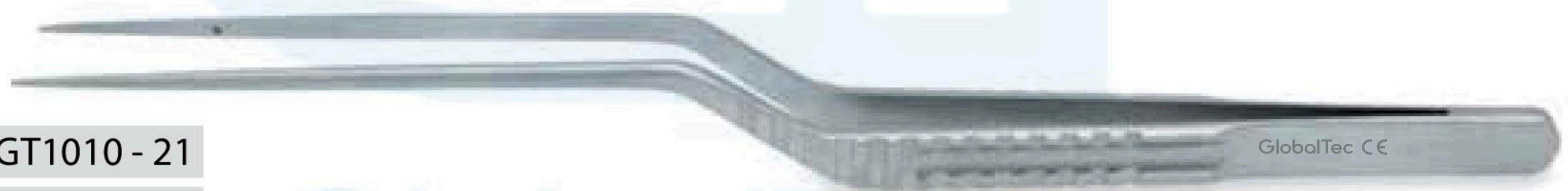

21cm/8 ¼"	MV GT1010 - 21
23cm/9"	MV GT1010 - 23

**Yasargil Bayonet Micro Scissors**

- Flat Handled
- 22.5cm/8 ¾" length

**Standard Blade**

Straight  
MV GT3005 - 22

**Vannas Blade**

Straight  
MV GT 3007 - 22



Curved  
MV GT 3006 - 22



Curved  
MV GT 3008 - 22



### SPINAL SURGERY

#### BIPOLAR FORCEPS

##### Straight Bipolar Forceps

- 10.5cm/4 1/4" length
- Delicate 1mm Jaws



##### Tip Size

0.7mm	GT-70 02 38
1mm	GT-70 02 43
Blunt	GT-70 02 41

##### Straight Bipolar Forceps

- 16.5cm/6 1/2" length

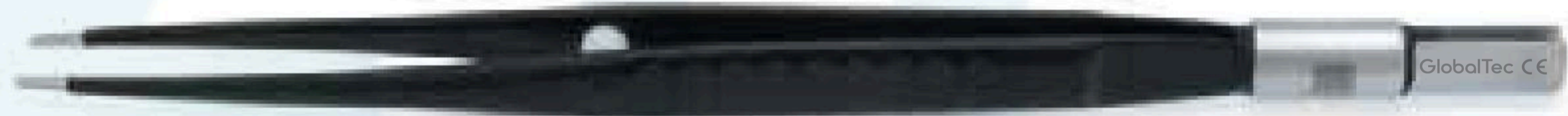

##### Tip Size

0.7mm	GT-70 01 52
1mm	GT-70 01 51

##### Straight Bipolar Forceps

- 19cm/7 1/2" length

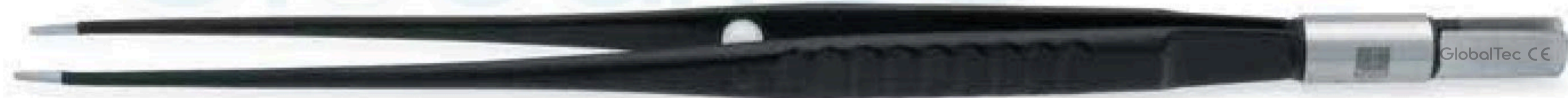

##### Tip Size

0.7mm	GT-70 01 72
1mm	GT-70 01 71

##### Bayonet Bipolar Forceps

- 19cm/7 1/2" length



##### Tip Size

0.7mm	GT-70 01 83
1mm	GT-70 01 81
Blunt	GT-70 01 82

**SPINAL SURGERY**
**BIPOLAR FORCEPS**
**Bayonet Bipolar Forceps**

- 23cm/9" length

**Tip Size**

0.3mm	GT -70 01 90
0.7mm	GT -70 01 91
1.2mm	GT -70 01 92

**Bayonet Bipolar Forceps**

- 25cm/9 ½" length

**Tip Size**

0.3mm	GT -70 01 90
0.7mm	GT -70 01 91
1.2mm	GT -70 02 92

**GT -37- 01- 35L**

- Fitting Block End Forceps
- Banana Plug Vallylab Machine Fitting
- 4.5 metre length

**GT -37- 01- 38L**

- Fitting Block End Forceps
- Erbe BM780 Machine Fitting
- 4.5 metre length

**Bayonet Bipolar Forceps Supergliss Non-Stick Tips**

- 23cm/9"



0.4mm	GT -78 01 99SG
0.7mm	GT -78 01 91SG
1.0mm	GT -78 01 98SG
1.2mm	GT -78 01 92SG



The material specially developed for SuperGliss non-stick forceps prevents overheating of the tips during coagulation. Laboratory tests confirm the outstanding non-stick properties that last throughout the lifetime of the instrument.

**SPINAL SURGERY**
**MISC INSTRUMENTS**
**Slim Nose Wire Twisters**

- 19cm/7 ½"



PSGT -7645 -19

**Orthopaedic Locking Grips**

- Hardened jaws

**Length**

GT -200-511-180	18cm/7"	Small
GT -200-511-200	20cm/8"	Medium
GT -200-511-240	24cm/9 ½"	Large

**Combined Wire Cutter & Pliers**

- 18cm/7"
- Suitable for wires up to 1.6mm



GT - 200-512-185

## SPINAL SURGERY

### MISC INSTRUMENTS

#### Bolt Cutters with dismantable arms

- Max. cap 6.3mm pins
- 57cm length

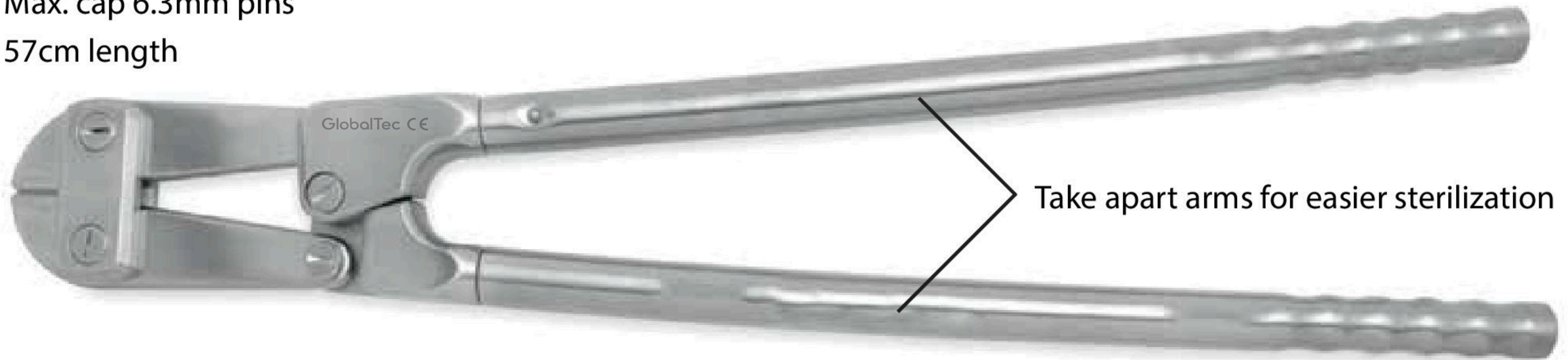

GT-200-500-585



- Must be used in conjunction with a Rod Holder. Ordering Code: 200 - 675 - 200

#### Muller-Claus Wire Cutters

- Tungsten Carbide Jaws
- Tungsten Carbide Jaws

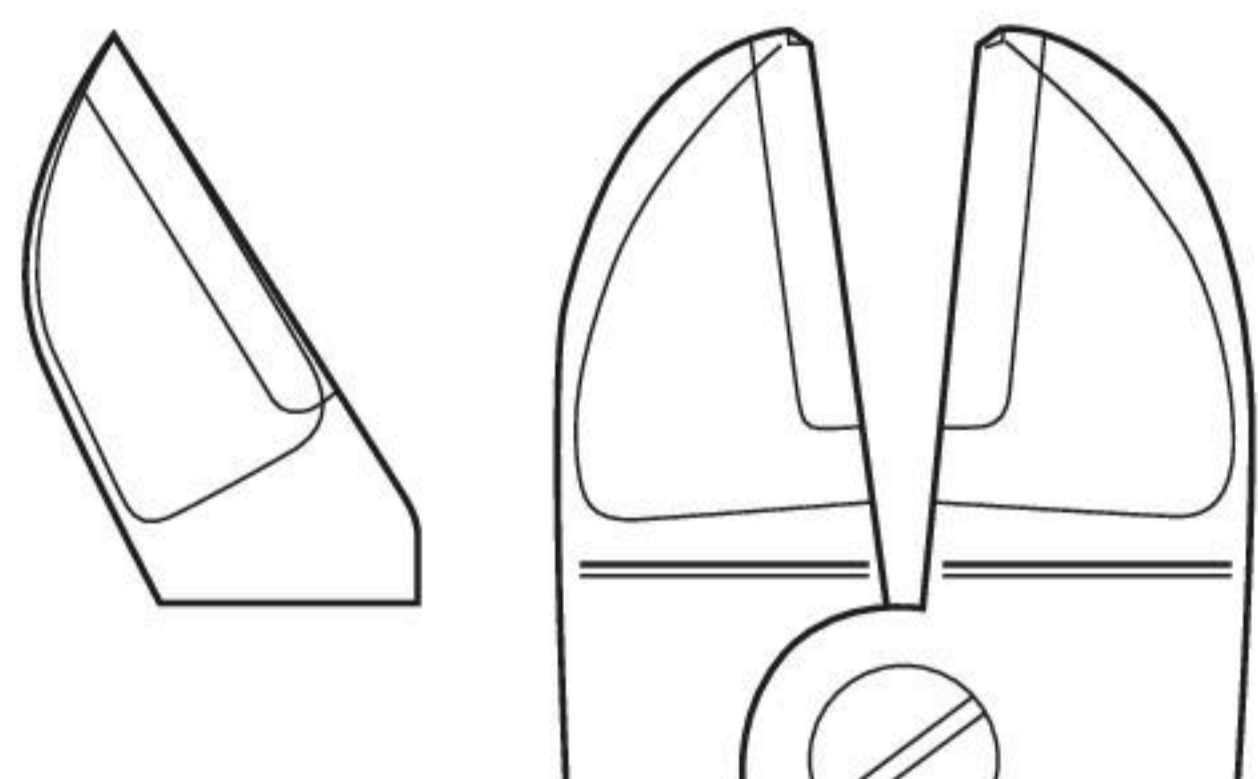

Length

GT-8 - 810E18

18cm/7"

Sui

GT-8 - 800E22

22cm/8 3/4"

Suitable for wires up to 3mm diameter



#### Needle Nosed Locking Pliers

- 18cm/7"
- Suitable for wires up to 1.6mm



Length

GT-200-514 - 220

22cm/8 3/4"

Small

GT-200-515 - 250

25cm/9 3/4"

Medium

GT-200-516 - 300

30cm/11 1/2"

Large

- A very useful instrument for orthopaedic surgery allowing the surgeon to securely clamp on to wires and implants.

**SPINAL SURGERY**
**MISC INSTRUMENTS**
**Measuring Caliper**

- 25cm/10"

PS GT 7334 - 20

**Castroviejo Caliper**

- 7cm/2¾"
- Measuring range 3mm to 25mm

PS GT 7334 - 10

**Vernier Caliper**

- 22.5cm/9"
- Measuring range 15cm

PS GT 7338 - 00

**Depth Gauge**

- Measuring depth up to 50mm

PS GT 7350 - 00

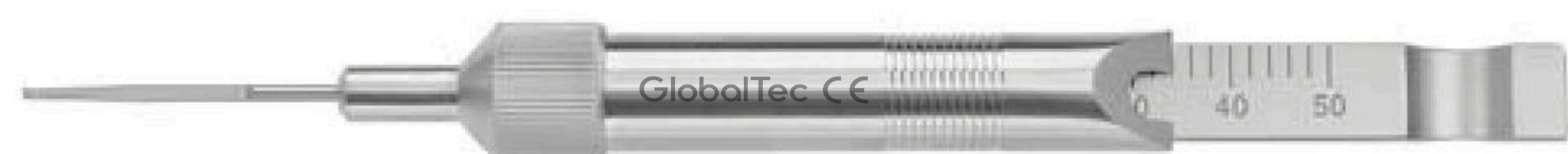
**Depth Gauge**

- Measuring depth up to 00mm

PS GT 7370 - 00

**Direct Reading Depth Gauge**

- 23cm length
- Measuring range 0.5 to 40mm

PS GT7333 - 00



**SPINAL SURGERY**
**MISC INSTRUMENTS**
**Frazier Suction Tube**

- 17cm/6 ¾"

PS GT 9041-17	6FG	2.0mm
PS GT 9042-17	7FG	2.3mm
PS GT 9043-17	8FG	2.7mm
PS GT 9044-17	9FG	3.0mm
PS GT 9045-17	10FG	3.3mm
PS GT 9046-17	11FG	3.7mm
PS GT 9047-17	12FG	4.0mm

**Frazier Suction Tube**

- 23cm/9"

PS GT 9041-23	6FG	2.0mm
PS GT 9042-23	7FG	2.3mm
PS GT 9043-23	8FG	2.7mm
PS GT 9044-23	9FG	3.0mm
PS GT 9045-23	10FG	3.3mm
PS GT 9046-23	11FG	3.7mm
PS GT 9047-23	12FG	4.0mm



**Bayonet Dissecting Forceps**

19cm/7 ½" Tip Size

PS GT9701-19	1mm
PS GT 9702-19	2mm

21cm/8 ½" Tip Size

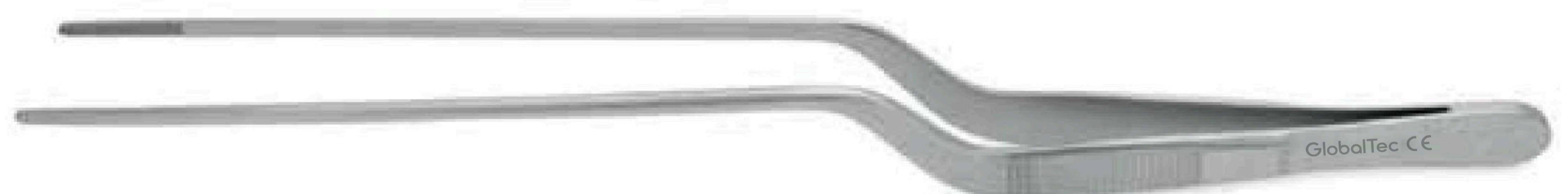
PS GT 9701- 21	1mm
PS GT9702- 21	2mm



**SPINAL SURGERY**

**GT SPECIAL RETRACTORS**

Finochietto Spine Retractor

PS GT 9702-01



Dr Remani Micro Dissectomy Retractor

PS GT 9703-01



**SPINAL SURGERY**

**GT SPECIAL RETRACTORS**

Mayfield Skull Retractor System

PS-GT 9704-01



**SPINAL SURGERY**

**GT SPECIAL RETRACTORS**

Wilson Radiolusent Frame

9705-01



MIS Tublar Retractor System

PS GT 9706-01

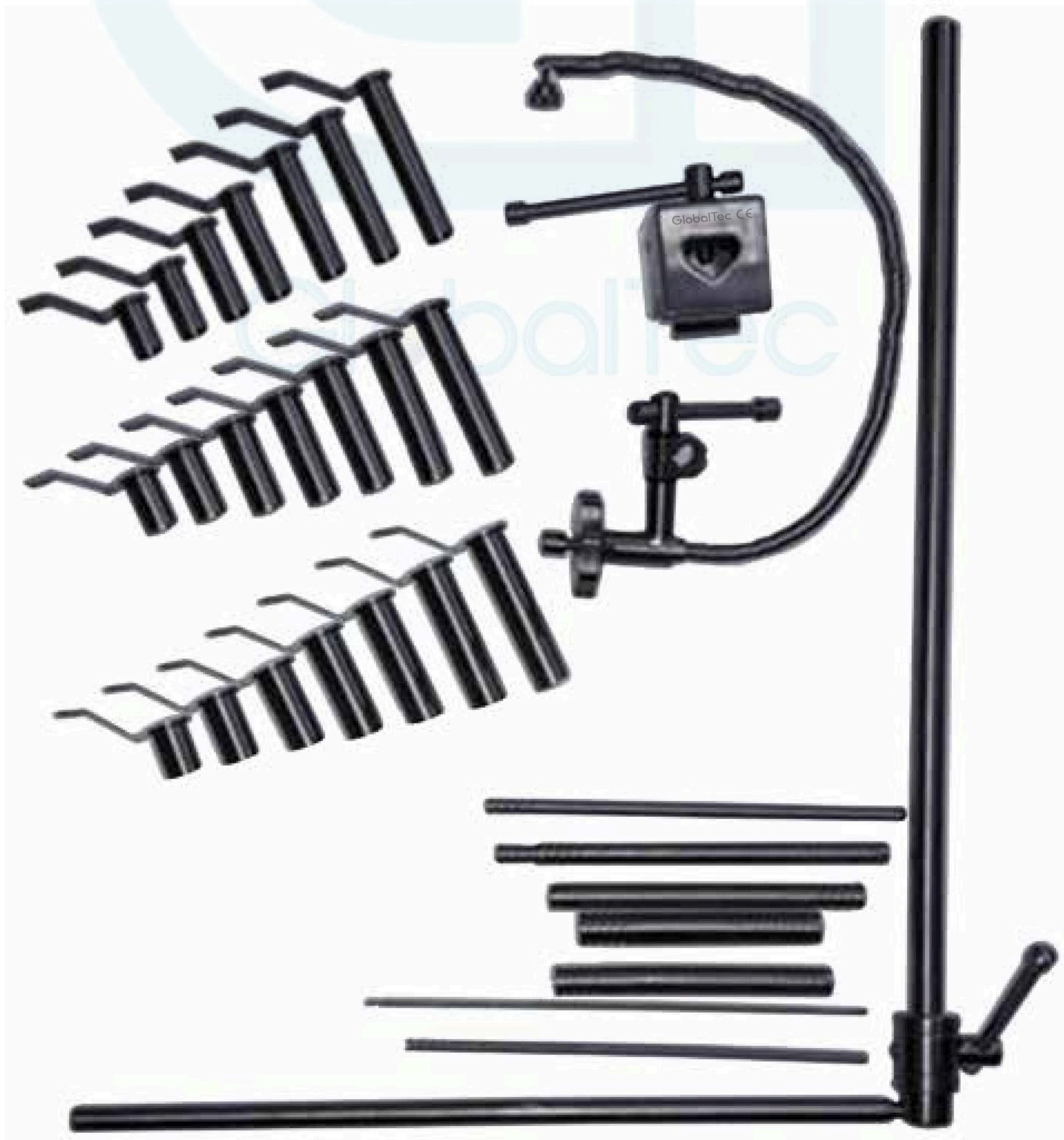

**SPINAL SURGERY**

**GT SPECIAL RETRACTORS**

Leyla Self Retaining Retractor System

PS GT 9707-01



# Great Creations Comes From The Sincerity

## WHO WE ARE

GlobalTec Surgical Instruments is a trusted provider of high-quality specialty surgical instruments. With deep industry expertise, our specialists ensure precision, reliability, and 100% customer satisfaction.

We deliver unmatched value with a surgeon satisfaction guarantee, offering instruments tailored to your exact specifications. With 99% customer satisfaction, we ensure superior quality and performance in every product.

Our strength lies in our skilled professionals and commitment to excellence, providing only the best instruments that meet the highest industry standards.



## Our Other Products :

Cardiac Surgery • Endoscopic Surgery • Gynecology Surgery • General Surgery  
Hand Surgery • Micro Surgery • Plastic Surgery  
Angioplasty Surgery • Spine Surgery

★ **CDSCO Reg No: Global-thris-KL/M/MD/019721** ★



+91 7994555004  
Office +91 04802733660  
sales@globaltecsurgical.com

DOOR No. 17/240, MELOOR P O, CHALAKUDY, THRISSUR, KERALA - 680 311

Email: info@globaltecsurgical.com, sales@globaltecsurgical.com, customercare@globaltecsurgical.com,

Website: www.globaltecsurgical.com. Phone: +91 0480 2733660 Mob: +91 7994555004

*Thank you*



DOOR No. 17/240, MELOOR P O, CHALAKUDY, THRISSUR, KERALA - 680 311

Email : [info@globaltecsurgical.com](mailto:info@globaltecsurgical.com), [sales@globaltecsurgical.com](mailto:sales@globaltecsurgical.com), [customercare@globaltecsurgical.com](mailto:customercare@globaltecsurgical.com)

Website: [www.globaltecsurgical.com](http://www.globaltecsurgical.com) | Phone : +91 0480 2733660 | Mob : +91 7994555004